ND1301:2001/03

DPNSS [188]

Digital Private Signalling System No 1 (DPNSS 1)

(Note: This Issue (published May 2005) now contains the previously omitted Section 28, there have been no other changes from the previous issue.)

© 2002 Crown Copyright

NOTICE OF COPYRIGHT AND LIABILITY

Copyright

All right, title and interest in this document are owned by the Crown and/or the contributors to the document unless otherwise indicated (where copyright be owned or shared with a third party). Such title and interest is protected by United Kingdom copyright laws and international treaty provisions.

The contents of the document are believed to be accurate at the time of publishing, but no representation or warranty is given as to their accuracy, completeness or correctness. You may freely download, copy, store or distribute this document provided it is not modified in any way and it includes this copyright and liability statement.

You may not modify the contents of this document. You may produce a derived copyright work based on this document provided that you clearly indicate that it was created by yourself and that it was derived from this document and provided further that you ensure that any risk of confusion with this document is avoided.

Liability

Whilst every care has been taken in the preparation and publication of this document, NICC, nor any committee acting on behalf of NICC, nor any member of any of those committees, nor the companies they represent, nor any person contributing to the contents of this document (together the "Generators") accepts liability for any loss, which may arise from reliance on the information contained in this document or any errors or omissions, typographical or otherwise in the contents.

Nothing in this document constitutes advice. Nor does the transmission, downloading or sending of this document create any contractual relationship. In particular no licence is granted under any intellectual property right (including trade and service mark rights) save for the above licence to copy, store and distribute this document and to produce derived copyright works.

The liability and responsibility for implementations based on this document rests with the implementer, and not with any of the Generators. If you implement any of the contents of this document, you agree to indemnify and hold harmless the Generators in any jurisdiction against any claims and legal proceedings alleging that the use of the contents by you or on your behalf infringes any legal right of any of the Generators or any third party.

None of the Generators accepts any liability whatsoever for any direct, indirect or consequential loss or damage arising in any way from any use of or reliance on the contents of this document for any purpose.

If you have any comments concerning the accuracy of the contents of this document, please write to:

The Technical Secretary,
Network Interoperability Consultative Committee,
OfTel,
50 Ludgate Hill,
London,
EC4M 7JJ.

DIGITAL PRIVATE NETWORK SIGNALLING SYSTEM NO 1 (DPNSS 1)

SECTION 0 - FOREWORD AND TABLE OF CONTENTS

CONTENTS

1	FOREWORD	Page 2
2	TERMINOLOGY	Page 3
3	NETWORK MANAGEMENT	Page 4
4	TABLE OF CONTENTS	Page 5
5	OVERALL COMPLIANCE SHEET FOR A PBX OFFERING SUPPLEMENTARY SERVICES	Page 8
6	HISTORY OF DPNSS[188]	Page 12
7	REFERENCES	Page 14

HISTORY

Issue 1 - May 1983
Issue 2 - February 1984
Issue 3 - September 1984
Issue 4 - March 1986
Issue 5 - December 1989
Issue 6 - January 1995

Issue 7 - March 2001 - Responsibility for the DPNSS 1
Specification transferred from
British Telecommunications to NICC
- Specification renamed as DPNSS[188]
- References changed
- Revised FOREWORD
- Revised TABLE OF CONTENTS
- Revised OVERALL COMPLIANCE Subsection

1 FOREWORD

This specification defines a signalling system (DPNSS 1) for use between switching nodes (eg PBXs) in digital private networks. To facilitate understanding it is written generally in terms of a conventional voice network, but in practice it is not restricted to this application. Most Supplementary Services, for example, are applicable to both voice and data. Other fields of application include Centrex and Virtual Private Networks (VPNs).

THIS SPECIFICATION DOES NOT CONCERN ITSELF WITH HOW A PBX INTERFACES WITH A TELEPHONE EXTENSION OR DATA TERMINAL OR THE USE TO WHICH A TRAFFIC CHANNEL IS PUT ONCE A CONNECTION HAS BEEN ESTABLISHED AND ANSWERED.

For a PBX to be accepted as supporting the Digital Private Network Signalling System No 1 (Issue 7) it shall, as a minimum, conform to the requirements of SECTIONS 0 to 5 and at least one of the two SECTIONS 6 and 7 of this issue of the specification.

In the same way that a customer may specify a subset of the total Supplementary Service capability of an individual PBX he may specify a subset of the capabilities of DPNSS 1 for the whole private network.

The specification of the requirements for DPNSS 1 is more complex than for an individual PBX because it embraces the choice both of the range of Supplementary Services and of the roles to be played by each PBX in the network. It may also involve more than one PBX supplier.

As an aid to understanding the services, SECTIONS 6 and above of DPNSS[188] each describe a service in terms of a complete network with each PBX in that network performing one or more specific functions, ie Transit, End or Branching.

In a given network it may not be necessary for every PBX to provide all of the functions in order for the network as a whole to support the required Supplementary Services, eg PBXs that perform only Transit functions need not provide the End function requirements specified in the service.

When a PBX supports a Supplementary Service the extent to which extensions on that PBX can access the service is a matter for negotiation between the purchaser and PBX supplier. However, in order to preserve the capabilities of PBXs to interwork in a DPNSS 1 private network, each PBX which claims to provide a given DPNSS 1 Supplementary Service in the network must meet a minimum requirement. This minimum requirement is that the PBX must be able to co-operate successfully with other PBXs in the network which invoke that service in accordance with the procedures of the appropriate SECTION of this specification.

Where optional Supplementary Services are offered, these must conform, either with the appropriate SECTIONS from this issue of the specification, or with the appropriate SECTIONS from other issues of the specification. In each case, it should be ensured that the Supplementary Service offered is compatible with the mandatory SECTIONS with which the PBX complies.

The purchaser must take care that PBX requirements are specified in such a way as to achieve an acceptable compromise between imposing constraints on the Supplementary Service potential of the network and purchasing redundant capability. In order to assist in this process and provide a consistent method of specification, each SECTION of the specification contains a Subsection on Compliance. These Subsections provide forms of compliance-statement which identify the choices available within a service. These compliance-statements can be used by a customer when specifying PBX requirements or by a manufacturer when stating PBX capability.

Whilst the compliance-statements can be used by a manufacturer to provide a generalised list of all possible capabilities on a particular type of PBX, a customer must ensure that a separate statement is prepared of the requirements for each PBX in the private network.

Where a PBX is required to provide more than one function, eg Transit and End, the compliance-statements should be completed for each function.

As a further aid to specification of requirements, Subsection 5 of this Section contains an overall compliance sheet for a PBX "total offering". An entry in TABLE 1 of Subsection 5 for a particular PBX function indicates that the PBX complies with at least one of the entries in TABLE 1 of the corresponding SECTION Compliance Statement for that function.

2 TERMINOLOGY

Throughout this specification, the term "PBX" is used to indicate a "switching node" on the network. Generally, this term is used to mean a Private Branch Exchange, but can mean Centrex, VPN or other types of equipment including those which have no telephone terminations (eg a Transit exchange, a data switch or a multiplexer).

Similarly, throughout this specification the term "Extension" is used to indicate an originating or terminating process for a call through the network. Generally, this term is used to mean a telephone instrument and its associated PBX hardware and software, but can mean other types of termination, eg a data terminal and associated PBX hardware and software or, in the case of services such as Remote Alarm Reporting (SECTION 28) and Time Synchronisation (SECTION 30), some form of internal PBX process.

Terms which have a special meaning in this specification are identified by the use of initial capitals (eg "Virtual Call") and

are normally defined in the Glossary of Terms SECTION 1, Subsection 5.

The signalling messages and their component parts are often referred to by mnemonics; these also appear in the glossary but are more fully defined, together with their coding, in SECTION 4.

3 NETWORK MANAGEMENT

Supplementary Services associated with network management facilities described in this document involve the exchange of small amounts of data between PBXs, eg Remote Alarm Reporting (SECTION 28), and in such cases the data is carried in the Signalling Channel and its format is specified in this specification.

Network management facilities involving potentially large amounts of data, eg remote maintenance and remote monitoring are not currently specified in this specification. However, this does not preclude the provision of such features in a DPNSS 1 network since the Circuit-Switched Data Call (see SECTION 7) permits a data connection to be established over circuit-switched Traffic Channels which could be used to interconnect network management entities. The specification of the format of data carried in this way is outside the scope of this specification.

4 TABLE OF CONTENTS

SECTION 0	FOREWORD AND TABLE OF CONTENTS	Issue 7
SECTION 1	GENERAL	Issue 7
SECTION 2	PHYSICAL CHARACTERISTICS (LEVEL 1)	Issue 6
ANNEX 1	PHYSICAL CHARACTERISTICS OF THE 2048 kbit/s DIGITAL TRANSMISSION SYSTEM INTERFACE	Issue 6
ANNEX 2	PHYSICAL CHARACTERISTICS OF THE V-SERIES DIGITAL INTERFACE	Issue 6
ANNEX 3	PHYSICAL CHARACTERISTICS OF THE X-SERIES DIGITAL INTERFACE	Issue 2
ANNEX 4	PHYSICAL CHARACTERISTICS OF THE 1544 kbit/s DIGITAL TRANSMISSION SYSTEM INTERFACE	Issue 2
SECTION 3	DATA-LINK LAYER (LEVEL 2)	Issue 6
SECTION 4	MESSAGE TYPES AND FORMATS	Issue 7
ANNEX 1	CODING OF SERVICE INDICATOR CODES	Issue 7
ANNEX 2	CODING AND DEFINITION OF SUPPLEMENTARY INFORMATION STRINGS	Issue 7
ANNEX 3	CODING OF CLEARING/REJECTION CAUSES	Issue 7
ANNEX 4	ALPHANUMERIC CHARACTER SET	Issue 7
ANNEX 5	MESSAGE TYPE CODES	Issue 7
ANNEX 6	MAINTENANCE ACTIONS	Issue 4
ANNEX 7	CODING OF USAGE IDENTIFIERS	Issue 1
SECTION 5	LEVEL 3 SIGNALLING PROCEDURES	Issue 6
ANNEX 1	MESSAGE SEQUENCE DIAGRAM (MSD) SYMBOLS USED IN DPNSS[188], DPNSS[189] AND DPNSS[189-I] LEVEL 3 DESCRIPTIONS	Issue 2
ANNEX 2	SDL SYMBOLS USED IN DPNSS[188] AND DPNSS[189] LEVEL 3 DESCRIPTIONS	Issue 2
ANNEX 3	SDL DIAGRAMS FOR THE DPNSS 1 CHANNEL PROCESS AND MAINTENANCE CHANNEL PROCESS	Issue 4
ANNEX 4	INTERACTION OF SUPPLEMENTARY SERVICES	Issue 3
SECTION 6	SIMPLE TELEPHONY CALL	Issue 7
SECTION 7	CIRCUIT-SWITCHED DATA CALL	Issue 6
SECTION 8	SWAP	Issue 6
SECTION 9	CALL BACK WHEN FREE	Issue 6
SECTION 10	EXECUTIVE INTRUSION	Issue 6
SECTION 11	DIVERSION	Issue 6

SECTION 12 HOLD	Issue 5
SECTION 13 THREE PARTY	Issue 5
SECTION 14 CALL OFFER	Issue 5
SECTION 15 NON-SPECIFIED INFORMATION	Issue 5
SECTION 16 SERVICE-INDEPENDENT STRINGS	Issue 5
SECTION 17 CALL WAITING	Issue 5
SECTION 18 BEARER-SERVICE SELECTION	Issue 6
SECTION 19 ROUTE OPTIMISATION	Issue 4
SECTION 20 EXTENSION STATUS	Issue 4
SECTION 21 CONTROLLED DIVERSION	Issue 4
SECTION 22 REDIRECTION	Issue 5
SECTION 23 SERIES CALL	Issue 4
SECTION 24 THREE-PARTY TAKEOVER	Issue 4
SECTION 25 NIGHT SERVICE	Issue 4
SECTION 26 CENTRALISED OPERATOR	Issue 4
SECTION 27 TRAFFIC-CHANNEL MAINTENANCE	Issue 3
SECTION 28 REMOTE-ALARM REPORTING	Issue 4
SECTION 29 ADD-ON CONFERENCE	Issue 3
SECTION 30 TIME SYNCHRONISATION	Issue 3
SECTION 31 CALL BACK WHEN NEXT USED	Issue 3
SECTION 32 DO NOT DISTURB	Issue 3
SECTION 33 REMOTE REGISTRATION OF DIVERSION	Issue 4
SECTION 34 REMOTE REGISTRATION OF DO NOT DISTURB	Issue 3
SECTION 35 PRIORITY BREAKDOWN	Issue 3
SECTION 36 CALL-BACK MESSAGING	Issue 3
SECTION 37 LOOP AVOIDANCE	Issue 3
SECTION 38 FORCED RELEASE	Issue 3
SECTION 39 TEXT MESSAGE	Issue 3
SECTION 40 CHARGE REPORTING	Issue 2

SECTION 41 NETWORK-ADDRESS EXTENSION	Issue 2
SECTION 42 CALL PARK	Issue 2
SECTION 43 CALL DISTRIBUTION	Issue 2
SECTION 44 ROUTE CAPACITY CONTROL	Issue 2
SECTION 45 WAIT ON BUSY	Issue 2
SECTION 46 CALL PICK-UP	Issue 2
SECTION 47 TRAVELLING CLASS OF SERVICE	Issue 2
SECTION 48 NUMBER PRESENTATION RESTRICTION	Issue 2
SECTION 49 NON SPECIFIED INFORMATION MESSAGE	Issue 1

5 OVERALL COMPLIANCE SHEET FOR A PBX OFFERING SUPPLEMENTARY SERVICES

Compliance with SECTIONS 0 to 7 shall be to the same "GLOBAL" Issue of this specification. Piecemeal compliance with these Sections where one or more Sections are from different "GLOBAL" issues of this specification is not allowed.

In the case of Supplementary Services, however, these can be selected from different Global Issues of this specification subject to any restrictions listed in the individual Section Compliance Statements.

NOTE 1: A PBX shall comply with SECTIONS 0-5.

NOTE 2: A PBX shall, in addition, comply with i) or ii) or iii) below:

- i) SECTION 6
- ii) SECTION 7
- iii) SECTION 6 and SECTION 7

TABLE 1

SECTIONS	FUNCTION NOTE: see Individual SECTION Compliance for additional details.		DPNSS[188] GLOBAL ISSUE NUMBER WITH WHICH THE PBX COMPLIES
	END	TRANSIT ONLY	
0 FOREWORD & CONTENTS			NOTE 1
1 GENERAL			
2 PHYSICAL CHARACTERISTICS			
3 DATA-LINK LAYER (LEVEL 2)			
4 MESSAGE TYPES AND FORMATS			
5 LEVEL 3 SIGNALLING PROCEDURES			NOTE 2
6 SIMPLE TELEPHONY CALL			
7 CIRCUIT-SWITCHED DATA CALL			

SECTIONS	FUNCTION NOTE: see Individual SECTION Compliance for additional details.		DPNSS[188] GLOBAL ISSUE NUMBER WITH WHICH THE PBX COMPLIES
	END	TRANSIT ONLY	
8 SWAP			
9 CALL BACK WHEN FREE			
10 EXECUTIVE INTRUSION			
11.1 DIVERSION - IMMEDIATE			
11.2 DIVERSION - ON BUSY			
11.3 DIVERSION - ON NO REPLY			
12 HOLD			
13 THREE PARTY			
14 CALL OFFER			
15 NON-SPECIFIED INFORMATION			
16 SERVICE-INDEPENDENT STRINGS			
17 CALL WAITING			
18.1 BEARER-SERVICE SELECTION - MANDATORY			
18.2 BEARER-SERVICE SELECTION - PREFERRED			

SECTIONS	FUNCTION NOTE: see Individual SECTION Compliance for additional details.		DPNSS[188] GLOBAL ISSUE NUMBER WITH WHICH THE PBX COMPLIES
	END	TRANSIT ONLY	
18.3 BEARER-SERVICE SELECTION - NOTIFICATION			
19 ROUTE OPTIMISATION			
20 EXTENSION STATUS			
21 CONTROLLED DIVERSION			
22 REDIRECTION			
23 SERIES CALL			
24 THREE-PARTY TAKEOVER			
25 NIGHT SERVICE			
26 CENTRALISED OPERATOR			
27 TRAFFIC-CHANNEL MAINTENANCE		NA	
28 REMOTE-ALARM REPORTING			
29 ADD-ON CONFERENCE			
30 TIME SYNCHRONISATION			
31 CALL BACK WHEN NEXT USED			
32 DO NOT DISTURB			

SECTIONS	FUNCTION NOTE: see Individual SECTION Compliance for additional details.		DPNSS[188] GLOBAL ISSUE NUMBER WITH WHICH THE PBX COMPLIES
	END	TRANSIT ONLY	
33 REMOTE REGISTRATION OF DIVERSION			
34 REMOTE REGISTRATION DO NOT DISTURB			
35 PRIORITY BREAKDOWN			
36 CALL-BACK MESSAGING			
37 LOOP AVOIDANCE			
38 FORCED RELEASE			
39 TEXT MESSAGE			
40 CHARGE REPORTING			
41 NETWORK-ADDRESS EXTENSION			
42 CALL PARK			
43 CALL DISTRIBUTION			
44 ROUTE CAPACITY CONTROL			
45 WAIT ON BUSY			
46 CALL PICK-UP			
47 TRAVELLING CLASS OF SERVICE			

SECTIONS	FUNCTION NOTE: see Individual SECTION Compliance for additional details.		DPNSS[188] GLOBAL ISSUE NUMBER WITH WHICH THE PBX COMPLIES
	END	TRANSIT ONLY	
48 NUMBER PRESENTATION RESTRICTION			
49 NON SPECIFIED INFORMATION MESSAGE			

6 HISTORY OF DPNSS[188]

NOTE: From Issue 1 to Issue 6 this specification was known as BTR 188.

Issue 1 - May 1983

Issue 2 - February 1984 - SECTIONS 0-11 made Issue 2,
- SECTIONS 12-18 Issued.

Issue 3 - September 1984 - SECTIONS 0-11 made Issue 3,
- SECTION 16 deleted,
- SECTIONS 12-18 made Issue 2,
- SECTIONS 19-26 Issued,
- The document issued in 2 Volumes.

Issue 3.1 - August 1985 - Corrigenda to Volume 1 added,
- Corrigenda to Volume 2 added.

Issue 4 - March 1986 - SECTIONS 0-11 made Issue 4,
- SECTIONS 12-18 (except 16) made
Issue 3,
- SECTION 16 reissued as new service,
- SECTIONS 19-26 made Issue 2,
- SECTIONS 27-39 Issued,
- The document issued in 3 Volumes.

Issue 5 - December 1989 - SECTIONS 0-11 made Issue 5,
- SECTIONS 12-18 (except 16) made
Issue 4,
- SECTION 16 made Issue 3,
- SECTIONS 19-26 made Issue 3,
- SECTIONS 27-39 made Issue 2,
- SECTIONS 40-43 Issued,
- The document issued in 5 Volumes.

- Issue 5.1 - December 1993
- Corrigenda added to Issue 5,
 - SECTIONS 6 and 31 reissued,
 - Minor amendments to the text of:
SECTIONS 1-6; 8-11; 13, 16, 21, 22,
27, 31, 33, 37, and the SDL of:
SECTIONS 6 and 7.
- Issue 6 - January 1995
- Addenda added to Issue 5.1,
 - SECTIONS 0, 1, 4, and 5 updated,
 - SECTIONS 6, 22, and 33 optional
functionality added,
 - SECTION 16 new Strings added,
 - SECTION 18 revised Compliance
Tables,
 - New SECTIONS 44 - 48 added.
- Issue 7 - March 2001
- Specification renamed as DPNSS[188],
 - References updated,
 - Volume 5 discontinued,
 - New SECTION 4, ANNEX 7 added,
 - New SECTION 49 added,
 - Specific changes made to the
following SECTIONS:
 - SECTION 4
 - SECTION 4, ANNEX 2
 - SECTION 4, ANNEX 5
 - SECTION 5
 - SECTION 5, ANNEX 2
 - SECTION 5, ANNEX 3
 - SECTION 5, ANNEX 4
 - SECTION 6
 - SECTION 7
 - SECTION 11
 - SECTION 15
 - SECTION 16
 - SECTION 19
 - SECTION 22
 - SECTION 25
 - SECTION 32
 - SECTION 36
 - SECTION 46.

7 REFERENCES

DPNSS[189], DPNSS[189-I], BTNR 190;

CCITT Recommendations (Individual Sections contain references to
specific Recommendations);

CEPT Services and Facilities Handbook 1981, Section III PABX;

ISO Standard 2110 - 1980;

Standard ECMA 102;

British Standard BS 5249/1)

) Presentation of Time and Date.

ISO Standard ISO3307/1975)

DIGITAL PRIVATE NETWORK SIGNALLING SYSTEM NO 1 (DPNSS 1)

SECTION 1 - GENERAL

CONTENTS

1	GENERAL	Page 2
2	PRINCIPLES & FIELDS OF APPLICATION	Page 6
3	OUTLINE OF OPERATION	Page 6
4	DPNSS 1 NETWORK STRUCTURE	Page 9
5	GLOSSARY OF TERMS	Page 11

HISTORY

Issue 1 - May 1983
Issue 2 - February 1984
Issue 3 - September 1984
Issue 4 - March 1986
Issue 5 - December 1989
Issue 6 - January 1995

Issue 7 - March 2001 - Specification renamed as DPNSS[188]
- New items added to the Glossary

REFERENCES

DPNSS[189], DPNSS[189-I]
CEPT Services and Facilities Handbook SF2

1 GENERAL

1.1 The signalling requirements of the Digital Private Network Signalling System No 1 (DPNSS 1) are detailed in this specification.

This Section gives general information on the scope, the principles and fields of application and outlines the operation of DPNSS 1. Detailed requirements are given in subsequent Sections of this specification.

1.2 DPNSS 1 extends facilities normally only available between extensions on a single PBX to all extensions on PBXs that are connected together in a private network.

1.3 Signalling for a sophisticated range of facilities for Telephony and Circuit-Switched Data Communications is specified in a manner compatible with Public ISDNs.

1.4 DPNSS 1 is a common-channel signalling system and is primarily intended for use between PBXs in private networks via time-slot 16 of a 2048 kbit/s digital transmission system. Similarly it may be used in time-slot 24 of a 1.544 kbit/s digital transmission system.

It may also be used, however, in conjunction with a suitable modem or terminating equipment, via any analogue or digital transmission path which is dedicated to signalling. Note that such a signalling path may be either, physically separate from the traffic channels, or within the same tdm or fdm assembly that carries the traffic channels.

1.5 The successful operation of PBXs in a private network requires compatibility not only of signalling but also of other aspects, such as:

- Transmission
- Numbering plans
- Modems

This specification does not specify all other aspects; a customer planning to set up a private network using DPNSS 1 must satisfy himself that the components of the network are compatible in all aspects.

NOTE: Care should be taken when configuring a network to ensure that the regulations applicable in the country concerned are observed, eg regarding connection of inter-PBX circuits to the PSTN or ISDN.

1.6 The specification of DPNSS 1 is in terms of the International Organisation for Standardisation (ISO) Reference Model for Open Systems Interconnection (OSI), see FIGURE 1.

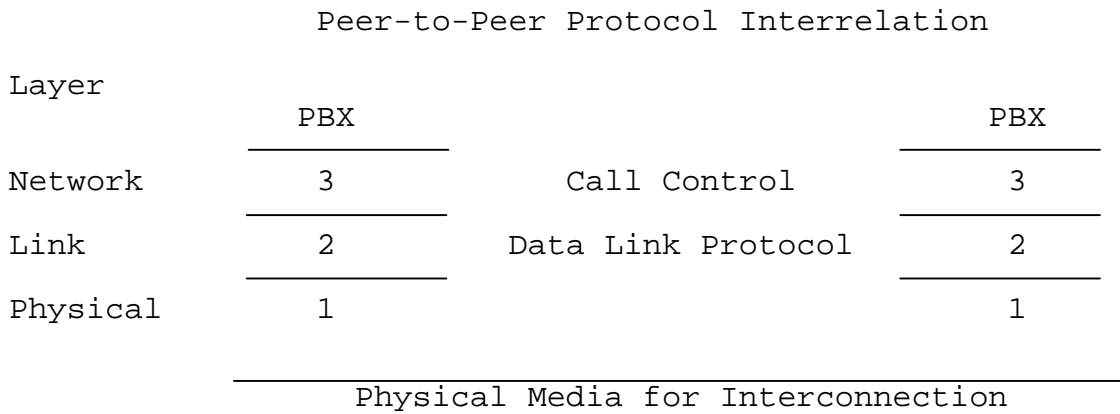

FIGURE 1: ISO REFERENCE MODEL

Using this model, signalling is effected between the inter-connected PBXs by a combination of peer layer protocols and interactions between adjacent layers.

1.7 For the purpose of this specification, Layers 1, 2 and 3 of the ISO reference model are referred to as Levels 1, 2 and 3, respectively.

1.8 Within this specification a DPNSS 1 PBX is considered to comprise a number of interacting processes. A block schematic diagram of a PBX showing the relationship between these processes is shown in FIGURE 2. Each process is specified in detail in subsequent Sections of this specification as referenced on the diagram.

FIGURE 2 is for explanation and overall functional specification only and is not intended to show the required method of realising a DPNSS 1 PBX. However, overall functional equivalence to FIGURE 2 must be achieved.

1.9 Within this specification the description is given in the form of text and Message Sequence Diagrams (MSDs). Some aspects of the specification are also described using SDL diagrams.

NOTE: The textual description and MSDs represent the definitive specification; the SDL diagrams, where provided, are only for the purpose of assisting in the understanding of the text.

MSDs are not produced for all aspects of DPNSS 1 (eg interactions between Supplementary Services are covered only by text).

1.10 This specification is structured such that SECTIONS 2 to 5 specify the essential core of the system and the procedures that are common to all of the services it supports.

SECTIONS above 5 specify individual services.

SECTION 6 details the Simple Telephony Call.

SECTION 7 details the Circuit-Switched Data Call.

To claim compliance with DPNSS 1, a PBX must support SECTIONS 0 to 5 plus at least one of SECTIONS 6 and 7.

SECTIONS 8 and above specify the signalling for the Supplementary Services that make up the network facilities of DPNSS 1. The provision of these Supplementary Services is optional and depends upon agreement between the purchaser and the PBX supplier.

SECTION 16 specifies a number of Service-Independent Strings which may optionally be used with simple calls (SECTION 6 and SECTION 7) or Supplementary Services (SECTIONS 8 and above).

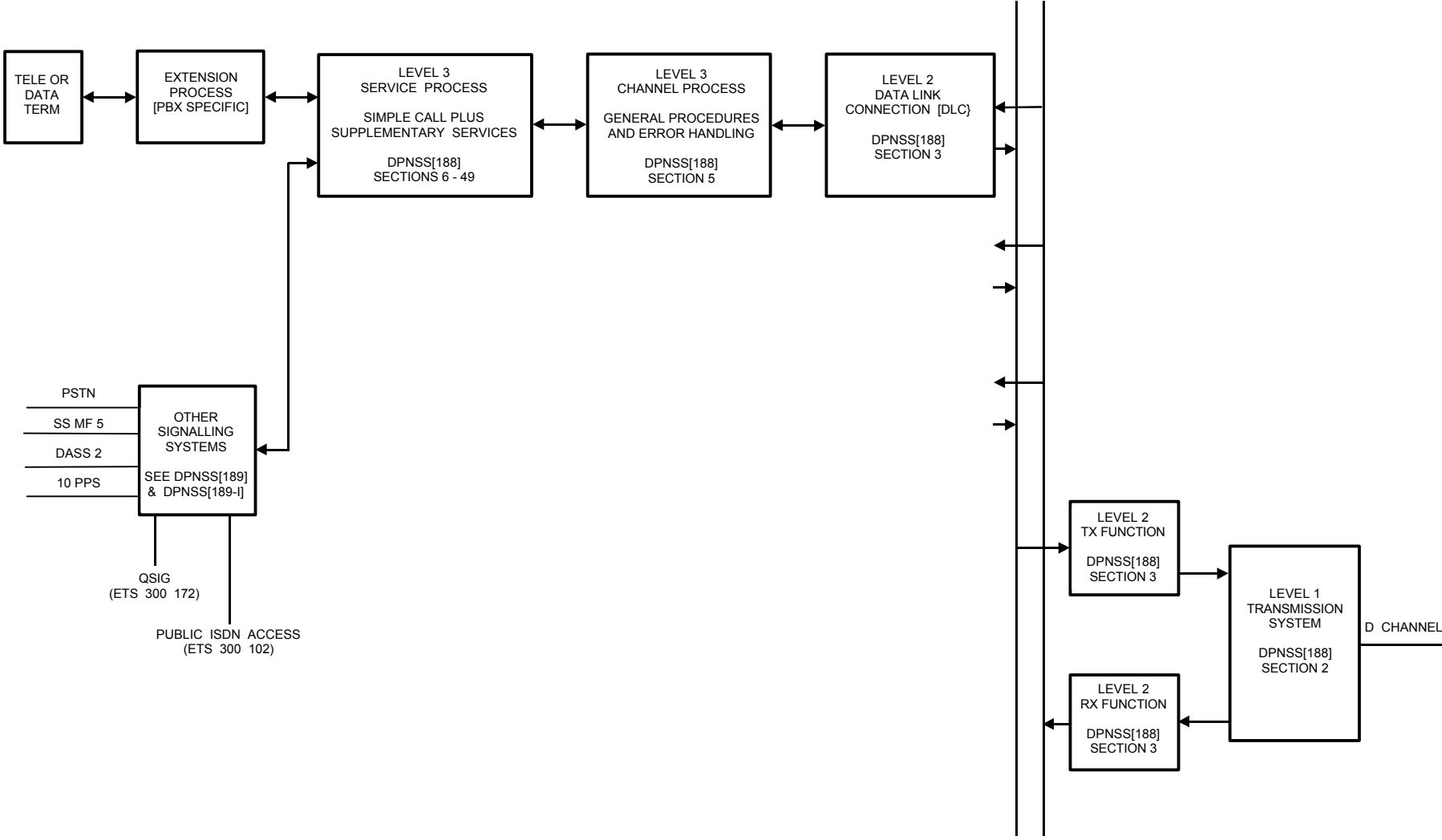

FIGURE 2: BLOCK SCHEMATIC OF MAIN PROCESSES IN A DPNSS 1 PBX

2 PRINCIPLES AND FIELDS OF APPLICATION

2.1 DPNSS 1 was originally derived from British Telecom's Digital Access Signalling System No 1 (DASS 1) enhanced where necessary to meet the Private Network Requirements. Some of these enhancements have been incorporated in DASS 2.

2.2 The services and procedures specified in this specification are based on the definitions and requirements given in CEPT/SF2 "Handbook on Services and Facilities" Section III, where applicable.

2.3 PBX-to-PBX call control signals are sent in the form of variable-length messages (Level 3), conveyed within the Information Field of HDLC type frames (Level 2).

2.4 The signalling information flows (Level 3), defined in this specification are intended to be suitable for transport in any message transfer part (Level 2). However, it is mandatory to support at least the DPNSS 1 Data Link Layer which is detailed in SECTION 3 of this specification.

2.5 At Level 3 DPNSS 1 includes a number of error-handling procedures to enable evolution of the system and to ensure that new services can be added with minimum retrospective impact on other PBXs in the network.

These error-handling features are detailed in SECTION 5 of this specification.

3 OUTLINE OF OPERATION

3.1 DPNSS 1 provides the signalling capability to establish simple telephony and data calls plus a wide range of Supplementary Services.

3.2 The range of Supplementary Services provided by a PBX is optional and depends upon customer requirements. PBXs of differing capabilities will be encountered and the procedures specified in this specification take this into account.

3.3 DPNSS 1 is capable of interworking, via a Gateway PBX, with the following signalling systems:

Private Network

- SSAC15
 - SSDC5
 - SSDC10
- } Decadic Signalling - Simple Call only
- SSMF5 - Supplementary Services to SSMF5 capability
 - QSIG - Basic Call to ETS 300 172 (1992)

Public Network

- Loop Disconnect (PSTN)
- DASS 2 (UK ISDN)
- Public ISDN Access - Basic Call to ETS 300 102-1 (1990)

Interworking details are given in DPNSS[189] and DPNSS[189-I].

NOTE: The fact that a signalling system is not listed here does not imply that an interworking facility cannot be achieved with that signalling system. Similarly, the fact that interworking with a supplementary service in another signalling system is not described within DPNSS[189] or DPNSS[189-I] does not mean that interworking with that supplementary service is not possible.

3.4 Signals are conveyed between PBXs within addressed messages. DPNSS 1 works on a link by link basis with each message being passed to the adjacent PBX, which either acts upon it or repeats it to the next PBX dependent upon the message type and content.

3.5 The message types, formats and contents are detailed in SECTION 4 of this specification.

3.6 A connection may be established between two PBXs for:

- a simple telephony or data call
- a Supplementary Service
- passing supplementary information

The procedure for all of the above is essentially the same although with some Supplementary Services the connection may involve signalling only, ie a Virtual Call.

3.7 A principle of DPNSS 1 is to gain maximum utilisation of the inter-PBX channels by holding a connection for the shortest possible time; to this end, Simple Calls encountering busy, etc, and certain Supplementary Service Requests are immediately released by a backward-clearing message.

The clearing message may contain the state of destination and, if appropriate, an acknowledgement to a Supplementary Service signal and, if necessary, additional supplementary information.

3.8 Detailed signalling procedures are given in SECTION 5 and subsequent Sections to this specification. The following paragraphs give a brief outline of call establishment.

3.8.1 A call is initiated by the Originating PBX sending to the adjacent PBX a message containing the following:

- type of service required eg telephony or data;
- data rate and adaptation method if appropriate;
- Calling Line Category (CLC) eg ordinary extension, operator, PSTN, etc;
- the Originating Line Identity, if available, eg, extension number;
- a Supplementary Service Request or information, if appropriate, and,
- the required Destination Address.

3.8.2 On receipt of this message, the responding PBX either:

- routes the call to an extension within the PBX (see paragraph 3.8.3) or,
- routes the call to the next PBX and repeats the message, modified as necessary.

If the required outgoing route is not DPNSS 1 the Gateway PBX must provide the conversion between the different signalling systems (see DPNSS[189] and DPNSS[189-I]).

3.8.3 On receipt of the call establishment message the Terminating PBX will check the calling and called terminals for compatibility and the state of the called terminal.

If the call is unacceptable or if the called party is busy, out-of-service, etc, the connection will be released by the Terminating PBX sending a backward-clearing message.

This message will contain a signal indicating the reason for clearing.

If the incoming call can be accepted, an acknowledgement message is sent by the Terminating PBX and repeated by each Transit PBX back to the Originating PBX. The connection will be maintained awaiting further signalling.

The acknowledgement message will contain the following information:

- Called Line Category, eg ordinary extension, PSTN encountered, etc;
- the Called Line Identity, if available;
- the State of Destination eg, busy, free, if known, and,

- a Supplementary Service Request or supplementary information, if appropriate.

3.8.4 When the called terminal is answered, the Terminating PBX sends a Call Connected Message (Answer) which is repeated by each Transit PBX, back to the Originating PBX.

3.8.5 A Recall Message is provided to enable Supplementary Service Requests that require a second call via the existing channel to be made during an established call.

This message may be used in either the forward or the backward direction. In the forward direction, the recall may be used both before and after answer.

3.8.6 An End-to-End Message is provided to enable Supplementary Service signalling between the Originating and Terminating PBXs.

Intermediate Transit PBXs repeat the message without acting upon it.

A Link-by-Link Message is provided to enable supplementary signalling between adjacent PBXs.

3.8.7 At the end of the call the connection is released by an interchange of clearing messages. Clearing can be initiated from either end. The call is released on a link by link basis.

4 DPNSS 1 NETWORK STRUCTURE

A DPNSS 1 network comprises a number of "Nodes" interconnected by DPNSS 1 signalling links with some Nodes giving access to a number of different types of non-DPNSS 1 interfaces. These non-DPNSS 1 interfaces are considered to be "Users" of the DPNSS 1 network and are differentiated by category, eg, Ordinary Extension, Operator, PSTN, etc.

DPNSS 1 Nodes can be either PBXs within a Private Network or Public Exchanges that provide Business Communications Network capability in the form of Virtual Private Networks (VPN) and Centrex.

This Subsection identifies and describes the different types of Node and the different User categories.

4.1 PBX APPLICATION

Within a Private Network, PBXs perform a number of different roles. For the purpose of this specification, PBXs are considered to provide one, some or all of the following Functions:

4.1.1 Transit Function

The Transit function supports the interconnection of a call between two DPNSS 1 channels. The call may be the initial call set-up via new channels or, in the case of certain Supplementary Services, a new call over a channel that is already in use. The Transit function also supports the interconnection of two DPNSS 1 Virtual Channels.

4.1.2 End Function

The End function supports the interconnection of a DPNSS 1 channel to a "DPNSS USER" eg, an extension telephone, a non-voice terminal, a route to another signalling system, or a conference bridge.

The End function is provided by:

- an Originating PBX
- a Gateway PBX from another signalling system
- a Gateway PBX to another signalling system
- a Terminating PBX
- a Conference PBX

4.1.3 Branching Function

Some Supplementary Services result in a new call that is related to an existing call. In such a case, the new call may share channels on none, on some or on all of its path from its Originating PBX with an existing call. The Branching Function exists at the point where the two calls diverge and may occur at an Originating, a Terminating or a Transit PBX. As far as each call is concerned, the Branching Function is always accompanied by either an End or a Transit function.

4.2 PUBLIC EXCHANGE APPLICATION

4.2.1 Virtual Private Network (VPN)

The requirements of a VPN are detailed in appropriate public network specifications. In general, a VPN will conform to the Transit requirements of this specification, although, in many cases a greater degree of transparency to DPNSS 1 messages and their contents may be provided.

4.2.2 Centrex

When a Centrex Node forms part of a "Hybrid" DPNSS 1 private network, it shall behave as a DPNSS 1 End PBX.

5 GLOSSARY OF TERMS

5.1 INTRODUCTION

The purpose of this Subsection is to bring together, for reference, all of the mnemonics used in connection with DPNSS 1 signalling. Also included, for clarification and in order to remove any ambiguity in their interpretation, are definitions of some terms.

It should be of benefit to the newcomer in this field, and also to those who are extending the signalling system further and who wish to check on previously used mnemonics.

5.2 ALPHABETICAL LISTING OF THE GLOSSARY

10 pps	Decadic Signalling (DEC) at 10 pulses per second.
A10	SSMF5 Signal "A-10"
A12	SSMF5 Signal "A-12"
A13	SSMF5 Signal "A-13"
A14	SSMF5 Signal "A-14"
A2	SSMF5 Signal "A-2"
A5	SSMF5 Signal "A-5"
A7	SSMF5 Signal "A-7"
A8	SSMF5 Signal "A-8"
AC	Add-On Conference
-CBI	-Conference Bridge Identity
-CDC	-Clear Down Conference
-DR	-Details Request
-NAO	-No Add-On Currently Available
-PD	-Party Details
-PI	-Party Index
ACK	Acknowledgement
ACT	Activate
AD	Add-On
-O	-Added-On
-RQ	-Request
-V	-Validation
ADPCM	Adaptive Differential Pulse Code Modulation
AIS	Alarm Indication Signal
ARC	Auxiliary Route Restriction Class
AS	Alarm Status
-R	-Request
ASST-INFO	Assistance Information
AUTO-A	Autoanswer

B Channel	see Traffic Channel
BAS	Basic SSMF5
BBC	Back-Busy Control (see MA)
BEL	"Bell" IA5 character
BSS	Bearer-Service Selection
-M	-Mandatory
-N	-Notification
-P	-Preferred
BT	British Telecommunications plc trading name
BY-INFO	Busy Information (now Service Information SERV)
CA	Call Arrival Message
CAM	Call Accept Message
CAN	"Cancel" IA5 Character
CAUSE	(Clearing) Cause
CBC	Call Back Complete
CBM	Call Back Messaging
-C	-Cancel
-CSU	-Call Set-Up
-R	-Request
CBWF	Call Back When Free
-C	-Cancel Request
-CB	-Call Back Request
-CLB	-Call Back Call
-CSUD	-Call Set Up Delayed
-CSUI	-Call Set Up Immediate
-FN	-Free Notification
-R	-Request
CBWNU	Call Back When Next Used
-R	-Request
CC	Clearing Cause
-AB	-Access Barred
-ACK	-Acknowledgement
-AI	-Address Incomplete
-BY	-Busy
-CHOS	-Channel Out of Service
-CNR	-DTE Controlled Not Ready
-CON	-Congestion
-CT	-Call Termination
-FNR	-Facility Not Registered
-ICB	-Incoming Calls Barred
-INC	-Service Incompatible
-MNU	-Message Not Understood
-NAE-E	-NAE-Error
-NT	-Network Termination
-NU	-Number Unobtainable
-PFR	-Priority Force Release
-REJ	-Reject
-ROS	-Route Out of Service
-SCT	-Subscriber Call Termination
-SI	-Subscriber Incompatible

CC (Continued)	
-SNU	-Signal Not Understood
-SNV	-Signal Not Valid
-SOS	-Subscriber Out Of Service
-SSI	-Signalling System Incompatible
-STU	-Service Temporarily Unavailable
-SU	-Service Unavailable
-TRFD	-Transferred
-UNR	-DTE Uncontrolled Not Ready
CCF	Clear Confirmation Message
CCI	Call Charge Information
CCITT	The International Telegraph and Telephone Consultative Committee
CCM	Call Connected Message
CD	Call Distribution
-CSU	-Call Set Up
-DNQ	-Do Not Queue
-FN	-Free Notify
-LINK	-Linked
-Q	-Queue
-UNLINK	-Unlinked
CDIV	Controlled Diversion
CEPT	European Conference of Postal and Telecommunications Administrations
CH	Charge Reporting
-AC	-Account Code
-ACR	-Account Code Request
-ACT	-Active
-CLR	-Clear
-CR	-Cost Request
-CST	-Cost
-TR	-Time Rate
-UR	-Unit Rate
-UU	-Units Used
CHID	Channel Identity
CIM	Clear Indication Message
CLC	Calling/Called Line Category
-DASS2	-Digital Access Signalling System No 2 (now renamed CLC-ISDN)
-DEC	-Decadic
-ISDN	-Public ISDN (including DASS 2)
-MF5	-Signalling System Multifrequency No 5
-NET	-Network
-OP	-Operator
-ORD	-Ordinary extension
-PSTN	-Public Switched Telephone Network
CLI	Called Line Identity (Network Identity)
CO	Call Offer
COC	Connected Call
COS	Class of Service
CP	Call Proceeding
CRM	Clear Request Message
CS	Channel Seized

CUG	Closed User Group
CW	Call Waiting
D Channel	see Signalling Channel
D+AR	Data Rate and Adaptation method
D-SIC	DASS 2-SIC
DA	Destination Address
DASS 1	Digital Access Signalling System No 1
DASS 2	Digital Access Signalling System No 2
DC(1->4)	"Device Control" IA5 character
DCE	Data Communications Equipment
DDI	Direct Dialling In
DEACT	Deactivate
DEC	Decadic Signalling - a signalling system based on elements representing the decimal digits 0 to 9 (eg 10 pps dialling)
Decadic Signalling	see "DEC"
DEL	"Delete" IA5 character
DI	Device Identity
DIV	Diversion
-BY	-Bypass
-CA	-Cancellation All
-CB	-Cancellation on Busy
-CI	-Cancellation Immediate
-CR	-Cancellation on Ring Tone No Reply
-FM	-Follow Me
-RCA	-Remote Cancel All
-RCB	-Remote Cancel Busy
-RCC	-Remote Cancel Combined
-RCI	-Remote Cancel Immediate
-RCR	-Remote Cancel No Reply
-RSB	-Remote Set Busy
-RSC	-Remote Set Combined
-RSI	-Remote Set Immediate
-RSR	-Remote Set No Reply
-V	-Validation
DLC	Data Link Connection
DND	Do Not Disturb
-C	Clear
-O	Override
-S	Set
DPNSS 1	Digital Private Network Signalling System No 1
DPU-R	Directed Call Pick-Up - Request
DRS	Direct Route Select
DTE	Data Terminal Equipment

DVD	Diverted
-B	-On Busy
-E	-Externally
-I	-Immediate
-R	-On Ring Tone No Reply
DVG	Diverting
-B	-On Busy
-I	-Immediate
-R	-On Ring Tone No Reply
DVL	Diversion - Last Controlling Extension Identity
DVT	Divert
-B	-On Busy
-CF	-On Call Failure
-I	-Immediate
-I/B	-Immediate or On Busy
-R	-On Ring Tone No Reply
-RD	-Redirection
ECMA	European Computer Manufacturers Association
EEM(C)	End to End Message (Complete)
EEM(I)	End to End Message (Incomplete)
EI	Executive Intrusion
-C	-Convert
-I	-Intruded
-PVR	-Prior Validation Request
-R	-Request
-W	-Withdraw
EM	"End of Medium" IA5 Character
End of Selection	All information for routing the call has been provided.
ENH	Enhanced SSMF5
ENQ	Enquiry Call
EOC	End of Call
ERD	External Routing Disabled
ERM	End to End Recall Message
ESC	"Escape" IA5 character
ESRA	ECMA Standard for Rate Adaptation
EST	Extension Status Call
ET	Exchange Termination
ETS	European Telecommunication Standard
ETSI	European Telecommunications Standards Institute
EX	Extraordinary Extension

FCS	Frame Check Sequence
fdm	Frequency Division Multiplex
FE(0->5)	"Format Effectors" IA5 characters
FNR	Facility Not Registered (see CC)
FR-R	Forced Release - Request
GPU-R	Group Pick-Up - Request
H PSTN	Holding PSTN
HDG	Holding
HDL	High Level Data Link Control
HF	Hands-Free
-A	-Activated
-D	-Deactivated
HGF	Hunt-Group Forwarded
HOLD-REQ	Hold Request
I	ISDN
-BC	-Bearer Capability
-CC	-Clearing Cause
-CPN	-Calling Party/Connected Number
-CSA	-Calling Party/Connected Subaddress
-DSA	-Destination Subaddress
-HLC	-High Layer Compatibility
-LLC	-Low Layer Compatibility
-PROG	-Progress
IA5	International Alphabet No 5
ICB	Incoming Calls Barred
ICC	Intercom Call
ICI	Incoming Call Indication
ICL	Intrusion Capability Level
IG	Ignored
-SNU	-Signal Not Understood
-SU	-Service Unavailable
Indication Block	One or more Indication Fields used to transport the Indication Block (see SECTION 4, paragraph 4.2 for a description of the contents of an Indication Block).
Indication Field	SECTION 4, Subsection 2 defines the Indication Field for each message type that contains one. The contents of the Indication Field are defined in terms of the contents of the Indication Block (see Indication Block).
INT-A	Interim Answer
IPL	Intrusion Protection Level
-R	-Request
IPN	Interworking via a Private ISDN

IRD	Internal Routing Disabled
IS(1->4)	"Information Separator" IA5 character
ISDN	Integrated Services Digital Network
ISO	International Organisation for Standardisation
ISPBX	Integrated Services PBX
ISRM(C)	Initial Service Request Message (Complete)
ISRM(I)	Initial Service Request Message (Incomplete)
LA	Loop Avoidance
LBA	Loop-Back Abort (see MA)
LBC	Loop-Back Control (see MA)
Link	A Transmission facility directly connecting two PBXs.
LLM(C)	Link-by-Link Message (Complete)
LLM(I)	Link-by-Link Message (Incomplete)
LLRM	Link-by-Link Reject Message
LMM	Link-Maintenance Message
LMRM	Link-Maintenance Reject Message
LSB	Least-Significant Bit
M-INDEX	Message Index
MA	Maintenance Action
-ACK	-Acknowledge
-BBC	-Back-Busy Control
-LBA	-Loop-Back Abort
-LBC	-Loop-Back Control
-TCS-R	-Traffic-Channel Status-Request
MCI	Malicious Call Indication
MF5	Signalling System Multifrequency No 5
MSB	Most-Significant Bit
MSD	Message Sequence Diagram
NAE	Network-Address Extension
-CC	-Calling/Called Identity Complete
-CI	-Calling/Called Identity Incomplete
-DC	-Destination Complete
-DI	-Destination Incomplete
NAM	Number Acknowledge Message
NICC	Network Interoperability Consultative Committee
NIM	Network Indication Message
NLT	Non-Looped-Back Test
-PT	-Perform Test
-RES	-Result
-RQ	-Test Request
-SC	-Sequence Complete

NPR	Number Presentation Restriction
-A	-A Party
-B	-B Party
-O	-Other Party
NS	Night Service
-DA	-Deactivated
-DVD	-Diverted
-DVG	-Diverting
-DVT	-Divert
-N	-Notification
-RDVD	-Rediverted
-RDVG	-Rediverting
-RDVT	-Redivert
NSI	Non-Specified Information
NSIM	Non-Specified Information Message
NSL	Network Signalling Limit
NT	Network Termination
NUL	"Null" IA5 character
OCP	Originally Called Party
OLI	Originating Line Identity
OPD	Output Digits
-R	-Request
ORD	Ordinary
OSI	Open Systems Interconnection
PARK	Park Request
PASSW	Password
Path	A series of channels used by a call
PB	Priority Breakdown
-P	-Protection
-R	-Request
PBX	Private Branch Exchange
PCLG	Public Calling Party Number
-D	-Default
-P	-Provided
PCM	Pulse Code Modulation
PCON	Public Connected Number
-D	-Default
-P	-Provided
PDR	Power Down Request
PKD	Parked
PNO-IG	Public Network Operators - Interest Group
/ISC	/Interconnect Standards Committee
POTS	Plain Ordinary Telephone Service
ppm	parts per million
PSTN	Public Switched Telephone Network

PU	Call Pick-Up
-DVD	-Diverted
-DVG	-Diverting
-DVT	-Divert
Q	Queue
-INFO	-Information
-PRIO	-Priority
QSIG	An inter-PBX Signalling Protocol
RA	Rate Adaptation
RC	Rejection Cause (For Rejection Cause Qualifier see CC)
RCC	Route Capacity Control
-CA	-Capacity Available
-OI	-Override Invoked
RCF	Redirecting on Call Failure
RDG	Redirecting
Real Call	A DPNSS 1 call with associated traffic (B) channels, cf Virtual Call.
RECON	Reconnected
RED-BY	Redirection Bypass
REJ	Reject
RM(C)	Recall Message (Complete)
RM(I)	Recall Message (Incomplete)
RO	Ring Out
ROP	Route Optimisation
-CON	-Connected
-CSU	-Call Set Up
-INV	-Invite
-INVA	-Invite With Acknowledgement
-R	-Request
Routing Phase	The phase of the call from the point where the ISRM is sent until receipt of the NAM. For Supplementary Services using Single-Channel Working this is the phase from the point where the RM is sent until receipt of the NAM.
RR-SNU	Recall Rejected - Signal Not Understood
RRM	Recall Rejection Message
RTI	Routing Information
SABMR	Set Asynchronous Balanced Mode Restricted
SATB	Satellite Barred
SAVE	Save
SCE	Single Channel Enquiry
SCI	Subsequent Call Indication
SCIM	Single-Channel Clear Indication Message
SCN	Subscriber Changed Number

SCRM	Single-Channel Clear Request Message
SDL	Functional Specification and Description Language
Selection Block	One or more Selection Fields used to transport the Selection Block (see SECTION 4, paragraph 4.1 for a description of the contents of the Selection Block).
Selection Field	SECTION 4, Subsection 2 defines the Selection Field for each message type that contains one. The contents of the Selection Field is defined in terms of the contents of the Selection Block (see Selection Block).
SER	Series Call
-C	-Cancellation
-E	-Established
-R	-Request
SERV	Service Information
SF2	CEPT Services and Facilities Handbook Section III PABX
SFI	Supplementary Facilities Inhibited
SHTL	Shuttle
SI	Subscriber Incompatible (see CC)
SI	Supplementary Information
SI	"Shift In" IA5 Character
SIC	Service Indicator Code
Signalling Channel	A channel reserved for signalling used to support Real and Virtual calls. It may be carried on a discrete analogue or digital bearer or within a tdm or fdm assembly.
SIM-A	Simulated Answer
Simple Call	A telephony call within the DPNSS Network Boundary with no invocation of Supplementary Services (as per the protocol of DPNSS[188] SECTION 6).
SM	Swap Message
SN	Send Next
-REQ	-Request
SNU	Signal Not Understood
SO	"Shift Out" IA5 character
SOD	State of Destination
-B	-Busy
-F	-Free
-I	-Indeterminate
-REQ	-Request
SP	"Space" IA5 character
SPL	Split

SPM	Subscribers Private Meter
SSMF5	Signalling System Multifrequency No 5
SSRM(C)	Subsequent Service Request Message (Complete)
SSRM(I)	Subsequent Service Request Message (Incomplete)
SU	Service Unavailable
SUB	"Substitute Character" IA5 character
Supplementary Information (SI)	Information in a DPNSS 1 message in addition to a Destination Address or fixed information octets - usually in the form of SI Strings (and associated Parameters) - to be communicated from one PBX to another on a call.
Supplementary Service	Used to provide facilities and/or information not provided by a Simple Call.
SW	Swap
-R	-Rejected
-V	-Validation
TA	Terminal Adaptor
TAD	Time and Date
-R	-Request
TC(1->10)	"Transmission Control" IA5 character
TCOS	Travelling Class of Service
-R	-Request
TCS	Traffic Channel Status
-R	-Request (see MA)
tdm	time division multiplex
TEXT	Textual Display
TEXTM	Text Message
TID	Trunk Identity
TOS	Temporarily Out of Service
TOV	Three-Party Takeover
-R	-Request
-V	-Validation
Traffic Channel	A circuit switched channel which may be carried on a discrete analogue or digital bearer or within a tdm or fdm assembly.
TRFD	Transferred
TRFR	Transfer Request
TWP	Two Party

UA	Unnumbered Acknowledgement
UDC	User Data Control
UI(C)	Unnumbered Information (Command)
UI(R)	Unnumbered Information (Response)
UNR	DTE Uncontrolled Not Ready
V-NID	VPN Nodal Identity
VIC	VPN Initiated Clear
Virtual Call	A DPNSS 1 call with no associated Traffic (B) Channels.
VPN	Virtual Private Network
WOB	Wait On Busy

DIGITAL PRIVATE NETWORK SIGNALLING SYSTEM NO 1 (DPNSS 1)

SECTION 2 - PHYSICAL CHARACTERISTICS (LEVEL 1)

CONTENTS

1 GENERALPage 2
2 COMPLIANCEPage 3

ANNEX 1: PHYSICAL CHARACTERISTICS OF THE 2048 kbit/s DIGITAL TRANSMISSION SYSTEM INTERFACE

ANNEX 2: PHYSICAL CHARACTERISTICS OF THE V-SERIES DIGITAL INTERFACE

ANNEX 3: PHYSICAL CHARACTERISTICS OF THE X-SERIES DIGITAL INTERFACE

ANNEX 4: PHYSICAL CHARACTERISTICS OF THE 1544 kbit/s DIGITAL TRANSMISSION SYSTEM INTERFACE

HISTORY

Issue 1 - May 1983
Issue 2 - February 1984
Issue 3 - September 1984
Issue 4 - March 1986
Issue 5 - December 1989

Issue 6 - March 2001 - Specification renamed as DPNSS[188]

REFERENCES:

CCITT Recommendations G.701, G.703, G.704, G.705, G.711,
(From the Red Book - 1984) G.732, G.733, G.823, G.824, O.151,
O.171, V.11, V.22, V.22 bis, V.24,
V.26, V.27 bis, V.28, V.29, V.32
X.1, X.21, X.21 bis, X.24

ISO Standards: 2110-1980, 4903-1980

1 GENERAL

Standardisation of the physical characteristics of the signalling channels is essential for the interconnection of PBXs.

DPNSS 1 can operate over a signalling channel of any bit rate, but care must be taken to provide a bit rate which can support the expected signalling traffic, and which will not lead to unacceptable delays in message transmission.

ANNEX 1 of this Section reproduces the requirements specified for structuring a 2048 kbit/s digital transmission system to connect PBXs to Phase 2 of the ISDN in the UK. It is recommended that this structure be adopted for use on 2048 kbit/s digital leased lines used to interconnect PBXs and thereby carry DPNSS 1 on time slot 16.

ANNEX 4 of this Section describes a multiplex structure for use with North American 1544 kbit/s transmission systems.

Where the traffic between two PBXs in a DPNSS 1 network is too low to justify the use of a Primary Rate interface, an alternative means of carrying DPNSS 1 signalling is required:

ANNEX 2 of this Section describes a method suitable for transmission of signalling on a dedicated signalling circuit at a rate between 1200 bit/s and 9600 bit/s via either a rate adapted 64kbit/s digital circuit or an analogue circuit with modems.

ANNEX 3 of this Section describes a method suitable for transmission of signalling on a dedicated 64 kbit/s digital signalling circuit at rates up to 64 kbit/s.

2 COMPLIANCE

This Section defines four possible methods of transporting DPNSS 1. The choice of method depends upon the Private Network concerned and is a matter of negotiation between a customer and his supplier.

TABLE 1 lists the options available and may be used as an aid to these negotiations.

A customer must ensure that the PBXs at each end of a signalling link provide a compatible solution.

TABLE 1

PHYSICAL CHARACTERISTICS		COMMENT
2048 kbit/s Digital Transmission System Interface, with CRC (as defined in ANNEX 1).		
2048 kbit/s Digital Transmission System Interface, without CRC (as defined in ANNEX 1).		
V-Series Digital Interface (as defined in ANNEX 2). The customer must specify speed and modem type.		
X-Series Digital Interface (as defined in ANNEX 3). The customer must specify speed and DCE type.		
1544 kbit/s Digital Transmission System Interface (As defined in ANNEX 4).		

DIGITAL PRIVATE NETWORK SIGNALLING SYSTEM NO 1 (DPNSS 1)

SECTION 2

ANNEX 1: PHYSICAL CHARACTERISTICS OF THE 2048 kbit/s DIGITAL TRANSMISSION SYSTEM INTERFACE

1 INTRODUCTION

The interface shall be in accordance with the appropriate parts of CCITT Recommendations G.701, G.703, G.704, G.705, G.732 and G.823 of the Red Book 1984. For the purposes of this document these will be called G.701, G.703, G.704, G.705, G.732 and G.823. The appropriate parts of these recommendations and additional requirements are given below. If any incompatibility exists between these recommendations and this specification then the requirements of this specification shall apply.

2 PORTS

The interface will consist of two ports. For the purposes of this specification they will be designated the "Network Output Port" and the "Network Input Port". The Network Output Port will supply signals from the distant PBX and the Network Input Port will accept signals for the distant PBX.

3 CHARACTERISTICS OF THE DIGITAL SIGNAL AT THE NETWORK OUTPUT PORT

The digital signal at the Network Output Port will meet the requirements for G.703, paragraph 6 except where otherwise stated. The following options will apply:

- 3.1** One coaxial pair in each direction will be used.
- 3.2** The test load impedance will be 75 ohms resistive.
- 3.3** The nominal peak voltage of a mark (pulse) will be 2.37 V.
- 3.4** The peak voltage of a space (no pulse) will be 0 ± 0.237 V.

The maximum peak-to-peak jitter will be in accordance with Recommendation G.823, paragraph 2.

The maximum value of wander at the Network Output Port will not exceed 18 microseconds peak-to-peak.

4 CHARACTERISTICS OF THE DIGITAL SIGNAL PRESENTED TO THE NETWORK INPUT PORT

The digital signal presented to the Network Input Port shall be as defined in paragraph 3 but modified by the characteristics of the interconnecting coaxial pair (see paragraph 7).

The maximum value of wander applied to the Network Input Port shall not exceed 18 microseconds peak-to-peak.

5 CHARACTERISTICS OF THE NETWORK INPUT PORT

The input impedance of the Network Input Port will be nominally 75 ohms. The return loss when referred to 75 ohms will be better than the limits given in TABLE 1 for the two frequency ranges indicated.

TABLE 1

MINIMUM VALUES OF RETURN LOSS AT THE NETWORK INPUT PORT

Frequency Range	Limits
100 kHz to 3 MHz	20 dB
50 kHz to 100 kHz	15 dB

The tolerance to jitter at the network input port will be in accordance with the requirements of Recommendation G.823, paragraph 3. The optional values for f2 and f3 in Note 2 of TABLE 2/G.823 will not be used.

The Network Input Port will also have an immunity to interference in accordance with the following test condition:

A pseudo random test signal of sequence length $2^{15} - 1$ as described in CCITT Recommendation O.151, coded into the standard interface conditions, should have added to it a non-synchronous interfering signal with the same pulse shape as the wanted signal. The interfering signal should be combined with the wanted signal in an active combining network which has an overall zero loss in the signal path and an output impedance of 75 ohms, to give a signal-to-interference ratio of 18 dB.

During a time period of 3 minutes, no errors shall result when the combined signal, attenuated by up to the maximum specified interconnecting cable loss, is applied to the Network Input Port.

NOTE: It is not implied that the PBX is required to generate or detect the test pattern. However, the PBX Output Port must conform with the requirement.

6 CHARACTERISTICS OF THE DIGITAL INPUT PORT OF THE PBX CONNECTED TO THE NETWORK OUTPUT PORT

The Digital Input Port of the PBX connected to the Network Output Port shall meet the same requirements as described in paragraph 5 for the Network Input Port and shall be connected to the Network Output Port by a coaxial pair having characteristics in accordance with paragraph 7.

7 COAXIAL PAIRS

The coaxial pairs between the PBX and the interface shall be provided by the customer. Each pair shall have a nominal characteristic impedance of 75 ohms and an attenuation-frequency characteristic approximating to a \sqrt{f} law. The insertion loss of each pair shall not exceed 6 dB when measured at a frequency of 1024 kHz.

7.1 Earthing

7.1.1 Pair connecting the Network Output Port to the Input Port of the PBX

The outer conductor of this pair shall be connected to earth at the Network Output Port.

An optional facility shall be provided for the outer conductor of this pair to be either connected to earth or isolated from earth at the input port of the PBX. In normal operation, the outer conductor will be isolated from earth at the input port of the PBX.

7.1.2 Pair connecting the PBX Output Port to the Network Input Port

The outer conductor of this pair shall be connected to earth at the PBX.

An optional facility shall be provided for the outer conductor of this pair to be either connected to earth or isolated from earth at the Network Input Port. In normal operation, the outer conductor will be isolated from earth at the Network Input Port.

8 CHARACTERISTICS OF THE FRAME STRUCTURE

The characteristics of the frame structure shall be in accordance with G.704 paragraph 3.3 with the following exceptions or qualifications (see also paragraph 10 of this Annex):

8.1 All time slots except 0 and 16 shall be switchable.

8.2 Speech shall be encoded in accordance with G.732 paragraph 1.1.

8.3 Timing in a synchronised network (G.705, para 3.1.2.2) shall apply.

8.4 The requirements of Section 3 of G.732 shall apply for frame-alignment procedures.

NOTE: CCITT Recommendation G.704 leaves some of the bit allocations for the time-slot 0 unassigned and reserved for National Use. The use of these bits is for future definition and in the interim any combination received shall be accepted as valid.

8.5 Time slots 1 to 15 and 17 to 31 may be used for telephony or other services, as designated by the Service Indicator Code (SIC) at Level 3 (see SECTION 4 of this specification). The Time-Slot number is coded in the Data-Link Protocol Address Field (see SECTION 3 of this specification).

8.6 Common-channel signalling shall be used and this shall always be allocated to time-slot 16. No other time-slots shall be used for this purpose.

8.7 The requirements of G.704, para 3.3.3.1 shall apply for common-channel signalling (Bit 1 shall be transmitted first).

8.8 When a traffic channel is idle or held, ie not connected to an active party, the pattern shown in TABLE 2 shall be transmitted. This pattern shall not be used as an indication of an idle or barred condition of a channel since this information should be derived from the control or signalling functions.

TABLE 2

BITS	8	7	6	5	4	3	2	1
	0	0	1	0	1	0	1	0

8.9 Bits shall be transmitted in ascending numerical order, starting from bit 1 for each time-slot.

9 ALARMS

Alarms are given when there is a loss of signal, a loss of frame alignment or a high error rate.

9.1 Network Output Port

9.1.1 AIS at the Network Output Port

An Alarm Indication Signal (AIS) is an all "1"s condition at 2048 kbit/s \pm 50 ppm on the digital signal. The strategy for detecting the presence of AIS should be such that the AIS is detectable even in the presence of an error ratio of 1×10^{-3} . However, a signal with all bits except the frame-alignment signal in the "1"s state should not be mistaken for an AIS.

NOTE: AIS is locally generated at faulty equipment usually by a free running crystal oscillator and will therefore not be synchronised to any network reference timing.

If an Alarm Indication Signal (AIS) is present at the Network Output Port, this indicates an upstream loss of signal and that a maintenance alarm indication within the network has been activated.

9.1.2 Bit 3 in Time-Slot 0

If bit 3 of time-slot 0 goes to a 1 condition in those frames not containing the frame-alignment signal, this shall indicate that one or more of the following conditions has been detected in the direction from the PBX to the Network Input Port:

- 9.1.2.1 An error ratio worse than 1×10^{-3} ;
- 9.1.2.2 AIS;
- 9.1.2.3 Loss of signal;
- 9.1.2.4 Loss of frame-alignment.

9.2 Network Input Port

9.2.1 Bit 3 in Time-Slot 0

Bit 3 of time-slot 0 shall be set to a 1 condition in those frames not containing the frame-alignment signal when one or more of the following conditions are detected by the PBX in the direction from the Network Output Port to the PBX:

- 9.2.1.1 An error ratio worse than 1×10^{-3} ;
- 9.2.1.2 AIS;
- 9.2.1.3 Loss of signal;
- 9.2.1.4 Loss of frame-alignment.

10 CYCLIC REDUNDANCY CHECK PROCEDURE

As an option a PBX may incorporate the Cyclic-Redundancy-Check (CRC) Procedure described in G.704, paragraph 2.3.3.

This CRC procedure, which utilises some of the otherwise spare capacity of bit 1 of time-slot 0, provides an enhanced error monitoring capability on links between cooperating PBXs.

PBXs, when interworking with other PBXs which are unable or unwilling to cooperate with this procedure, shall comply with the note following paragraph 2.3.3 (a) of G.704.

A receiving PBX on a link which incorporates the CRC procedure may also utilise the check to obtain an enhanced frame-alignment performance. The details of the method are contained in G.706 {Recommendation G.706 was adopted by the CCITT in 1987 using the accelerated approvals procedure and is currently available in CCITT Report COM XVIII-R 25(C)}. Provided both PBXs incorporate and cooperate with the CRC check of G.704 paragraph 2.3.3, no extra cooperation is required for a PBX to incorporate the G.706 enhancement unilaterally.

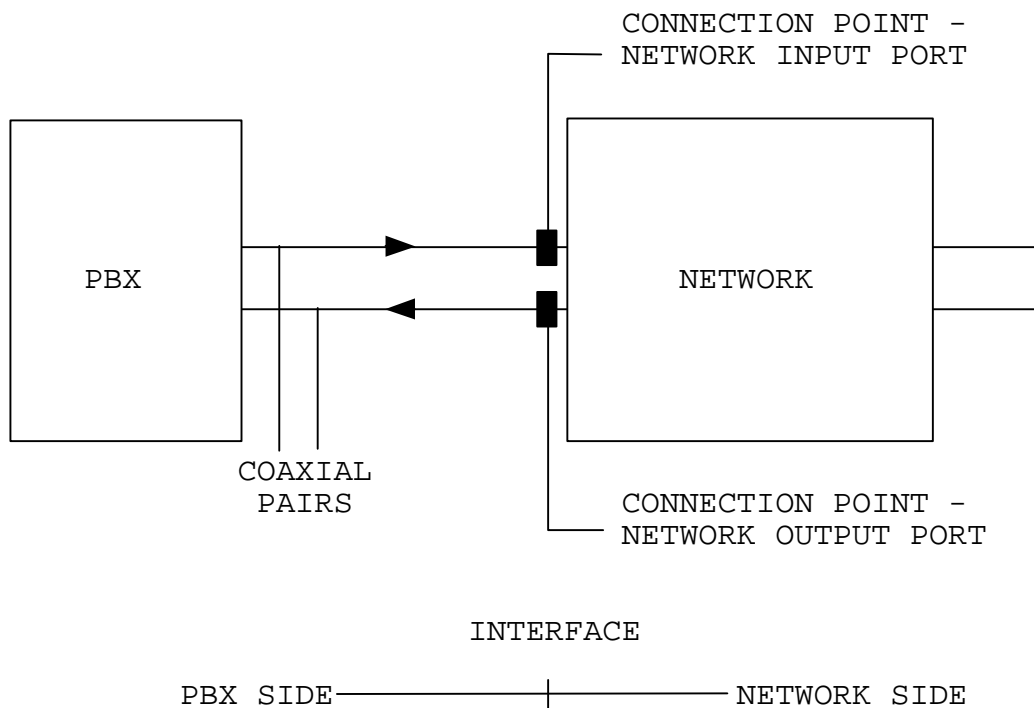

FIGURE 1: LOCATION OF THE CONNECTION POINTS AND INTERFACE

DIGITAL PRIVATE NETWORK SIGNALLING SYSTEM NO 1 (DPNSS 1)

SECTION 2

**ANNEX 2: PHYSICAL CHARACTERISTICS OF THE V-SERIES DIGITAL
INTERFACE**

1 INTRODUCTION

The interface shall be in accordance with the appropriate parts of: CCITT Recommendations V.22, V.22 bis, V.24, V.26, V.27 bis, V.28, V.29, V.32 and X.21 bis contained in the Red Book - 1984, and ISO Standard 2110 - 1980. For the purposes of this document these will be called V.22, V.22 bis, V.24, V.26, V.27 bis, V.28, V.29, V.32, X.21 bis, and ISO 2110.

The appropriate parts of these recommendations and the standard are referred to in more detail below. If any incompatibility exists between these recommendations and the standard on the one hand and this specification on the other hand then the requirements of this specification shall apply.

A requirement of this Section is that this interface must be capable of working in full-duplex mode at each of the data rates (1200, 2400, 4800 and 9600 bit/s) specified in Subsection 2 of this Annex.

2 THE DIGITAL INTERFACE PORT

The PBX shall operate as a V-Series Data Terminal Equipment (DTE) using the leased circuit (point-to-point) service defined in X.21 bis, Section 1.

The V.24 interchange circuits provided shall be those listed in TABLE 1:

NOTE: In order to ensure correct interworking between PBXs via this interface, particular attention should be paid to the operational requirements for the use of interchange circuits given in Section 4 of V.24.

TABLE 1

V.24 Interchange Circuit No.	Interchange-Circuit Name
102	Signal ground or common return
103	Transmitted data
104	Received data
105	Request to send
106	Ready for sending
107	Data set ready
108/1	Connect data set to line
109	Data channel received line signal detector
113	Transmitter signal element timing (DTE source)
114	Transmitter signal element timing (DCE source)
115	Receiver signal element timing (DCE source)
140	Remote loopback
141	Local loopback
142	Test indicator (DCE source)

Each interchange circuit in the PBX termination shall meet the requirements of V.28.

The connector on the PBX for the digital interface port shall be a 25-pin DTE connector as described in ISO 2110. The assignment of pin numbers to interchange circuits shall be as described in Table 2 of ISO 2110.

The nominal full-duplex synchronous data signalling rate shall be 1200, 2400, 4800, or 9600 bit/s, with a tolerance of 0.01%.

This will allow DPNSS 1 signalling to be carried over:

- i. a 64 kbit/s digital circuit with rate adaptation to 2400, 4800 or 9600 bit/s, terminated in accordance with X.21 bis; or
- ii. an analogue 4-wire circuit terminated with modems conforming to V.26 (2400bit/s), V.27 bis (4800 bit/s) or V.29 (9600 bit/s); or
- iii. an analogue 2-wire circuit terminated with modems conforming to V.22 (1200 bit/s), V.22 bis (2400 bit/s), or V.32 (4800 or 9600 bit/s).

3 TRAFFIC CIRCUITS

The association of traffic circuits to signalling circuits, and the means by which traffic circuits associated with the same signalling circuit are identified, are described in SECTION 3 of this specification.

Signalling on the traffic circuit (eg line or inter-register) shall not be used to control the connection.

DIGITAL PRIVATE NETWORK SIGNALLING SYSTEM NO 1 (DPNSS 1)

SECTION 2

ANNEX 3: PHYSICAL CHARACTERISTICS OF THE X-SERIES DIGITAL INTERFACE

1 INTRODUCTION

The interface shall be in accordance with the appropriate parts of: CCITT Recommendations V.11, X.1, X.21 and X.24 of the Red Book, 1984, and ISO Standard 4903 - 1980. For the purposes of this document, these will be called V.11, X.1, X.21, X.24 and ISO 4903.

The appropriate parts of these recommendations and the standard are referred to in more detail below. If any incompatibility exists between these recommendations and the standard on the one hand and this specification on the other hand then the requirements of this specification shall apply.

A requirement of this Section is that this interface must be capable of working, in full-duplex mode at 64000 bit/s as specified in Subsection 2 of this Annex. Optionally it may also work at any of the following data rates: 2400; 4800; 9600 and 48000 bit/s, as specified in Subsection 2 of this Annex.

2 THE DIGITAL INTERFACE PORT

The PBX shall operate as an X-Series Data Terminal Equipment (DTE) using the leased circuit (point-to-point) service defined in X.21 sections 1, 2 and 5.2.

The X.24 interchange circuits provided shall be those listed in TABLE 1:

NOTE 1: To ensure correct interworking between PBXs via this interface, particular attention should be paid to the operational requirements for the use of interchange circuits given in X.24.

TABLE 1

X.24 Interchange Circuit Designation	Interchange-Circuit Name
G	Signal ground or common return
T	Transmit
R	Receive
C	Control (see NOTE 2)
I	Indication (see NOTE 2)
S	Signal element timing

NOTE 2: Certain DCE equipment may not support the C and I circuits at certain data rates. Therefore, the PBX shall be able to operate, either permanently in the Data Transfer state using only the T, R and S circuits, or under the control of the C and I circuits, for the exchange of data.

Each interchange circuit in the PBX termination shall meet the requirements of V.11.

The connector on the PBX for the X-Series digital interface port shall be a 15-pin DTE connector as described in ISO 4903.

The nominal full duplex synchronous data-signalling rate shall be 2400, 4800, 9600, 48000 or 64000 bit/s (ie, X.1 Classes of Service 4, 5, 6, 7 or 30, respectively). A tolerance of 0.01% shall apply to the bit rate.

This will allow DPNSS 1 signalling to be carried over a 64 kbit/s digital circuit at 64 kbit/s, or, with rate adaptation, at 2400, 4800, 9600, or 48000 bit/s, terminated in accordance with X.21.

3 TRAFFIC CIRCUITS

The association of traffic circuits with signalling circuits, and the means by which traffic circuits associated with the same signalling circuit are identified, are described in SECTION 3 of this specification.

Signalling on the traffic circuit (eg line or inter-register) shall not be used to control the connection.

DIGITAL PRIVATE NETWORK SIGNALLING SYSTEM NO 1 (DPNSS 1)

SECTION 2

ANNEX 4: PHYSICAL CHARACTERISTICS OF THE 1544 kbit/s DIGITAL TRANSMISSION SYSTEM INTERFACE

1 INTRODUCTION

The interface shall be in accordance with the appropriate parts of CCITT Recommendations G.701, G.703, G.704, G.705, G.733 and G.824 of the Red Book 1984. For the purposes of this document these will be called G.701, G.703, G.704, G.705, G.733 and G.824. The appropriate parts of these recommendations and additional requirements are given below. If any incompatibility exists between these recommendations and this specification then the requirements of this specification shall apply.

2 PORTS

The interface will consist of two ports. For the purposes of this specification, they will be designated the "Network Output Port" and the "Network Input Port". The Network Output Port will supply signals from the distant PBX and the Network Input Port will accept signals for the distant PBX.

3 CHARACTERISTICS OF THE DIGITAL SIGNAL AT THE NETWORK OUTPUT PORT

The digital signal at the Network Output Port will meet the requirements for G.703, paragraph 2 except where otherwise stated. The line-code option B8ZS will apply.

The maximum peak-to-peak jitter will be in accordance with G.824, paragraph 3.

The maximum value of wander at the Network Output Port will be in accordance with G.824, paragraph 4.2.

4 CHARACTERISTICS OF THE DIGITAL SIGNAL PRESENTED TO THE NETWORK INPUT PORT

The digital signal presented to the Network Input Port shall be as defined in paragraph 3 of this Annex, but modified by the characteristics of the interconnecting cable pair (see paragraph 7 of this Annex).

The maximum value of wander applied to the Network Input Port shall be in accordance with G.824, paragraph 4.2.

5 CHARACTERISTICS OF THE NETWORK INPUT PORT

The input impedance of the Network Input Port will be nominally 100 ohms at 772 kHz.

The balance-to-earth and the return loss of this interface require further study.

The tolerance to jitter at the Network Input Port will be in accordance with the requirements of G.824, paragraph 3.

6 CHARACTERISTICS OF THE DIGITAL INPUT PORT OF THE PBX CONNECTED TO THE NETWORK OUTPUT PORT

The Digital Input Port of the PBX connected to the Network Output Port shall meet the same requirements as described in paragraph 5 for the Network Input Port and shall be connected to the Network Output Port by a cable pair having characteristics in accordance with paragraph 7.

7 CABLE PAIRS

The cable pairs between the PBX and the interface shall be provided by the customer. Each symmetrical (balanced) pair shall have a nominal characteristic impedance of 100 ohms and an attenuation-frequency characteristic approximating to a \sqrt{f} law. The insertion loss of each pair shall not exceed 6 dB when measured at a frequency of 772 kHz.

8 CHARACTERISTICS OF THE FRAME STRUCTURE

The characteristics of the frame structure shall be in accordance with G.704, Paragraph 3.1 with the following exceptions or qualifications:

8.1 The allocation of F-bits shall be as for the alternative described in subparagraph 3.1.1.3 for Method 1 - 24-frame multiframe. Common-channel signalling shall be used - see 8.8 below.

8.2 All time slots except 24 shall be switchable.

8.3 Speech shall be encoded in accordance with G.733, Paragraph 1.1 .

8.4 Timing in a synchronised network (G.705, para 1.1.2.2) shall apply.

8.5 The requirements of Section 3, Paragraph 3.1 of G.733 shall apply for frame-alignment procedures.

8.6 Time slots 1 to 23 may be used for telephony or other services, as designated by the Service Indicator Code (SIC) at Layer 3 (see SECTION 4 of this specification). The time slot number is coded in the Data Link Protocol Address Field (see SECTION 3 of this specification).

8.7 Common-channel signalling shall be used and this shall always be allocated to time slot 24. No other time slots shall be used for this purpose.

8.8 The requirements of G.704, paragraph 3.1.3.1, the 64 kbit/s option, shall apply for common channel signalling (Bit 1 of the signalling octet shall be transmitted first).

8.9 When a traffic channel is idle or held, ie not connected to an active party, the pattern shown in TABLE 1 shall be transmitted. This pattern shall not be used as an indication of an idle or barred condition of a channel since this information should be derived from the control or signalling functions.

TABLE 1

BITS	8	7	6	5	4	3	2	1
	0	1	1	1	1	1	1	0

8.10 Bits shall be transmitted in ascending numerical order, starting from bit 1 for each time slot.

9 ALARMS

Alarms are given when there is a loss of signal, a loss of frame-alignment or a high error rate.

9.1 Network Output Port

9.1.1 AIS at the Network Output Port

An Alarm Indication Signal (AIS) is an all "1"s condition at 1544 kbit/s \pm 50 ppm on the digital signal. The strategy for detecting the presence of AIS should be such that the AIS is detectable even in the presence of an error ratio of 1×10^{-3} . However, a signal with all bits except the frame-alignment signal in the "1"s state should not be mistaken for an AIS.

NOTE: AIS is locally generated at faulty equipment usually by a free running crystal oscillator and will therefore not be synchronised to any network reference timing.

If an Alarm Indication Signal (AIS) is present at the Network Output Port, this indicates an upstream loss of signal and that a maintenance alarm indication within the network has been activated.

9.1.2 Alarm Indication

Receipt of the Loss-of-Frame-Alignment (LFA) Sequence described in G.704, Paragraph 3.1.1.3 A) 3) shall be understood to indicate that one or more of the following conditions has been detected at the remote PBX:

- 9.1.2.1 An error ratio worse than 1×10^{-3} ;
- 9.1.2.2 AIS;
- 9.1.2.3 Loss of incoming signal;
- 9.1.2.4 Loss of incoming frame-alignment.

9.2 Network Input Port

9.2.1 Alarm Indication

The Loss-of-Frame-Alignment (LFA) Sequence described in G.704, Paragraph 3.1.1.3 A) 3) shall be transmitted when one or more of the following conditions are detected by the PBX in the direction from the Network Output Port to the PBX:

- 9.2.1.1 An error ratio worse than 1×10^{-3} ;
- 9.2.1.2 AIS;
- 9.2.1.3 Loss of signal;
- 9.2.1.4 Loss of frame-alignment.

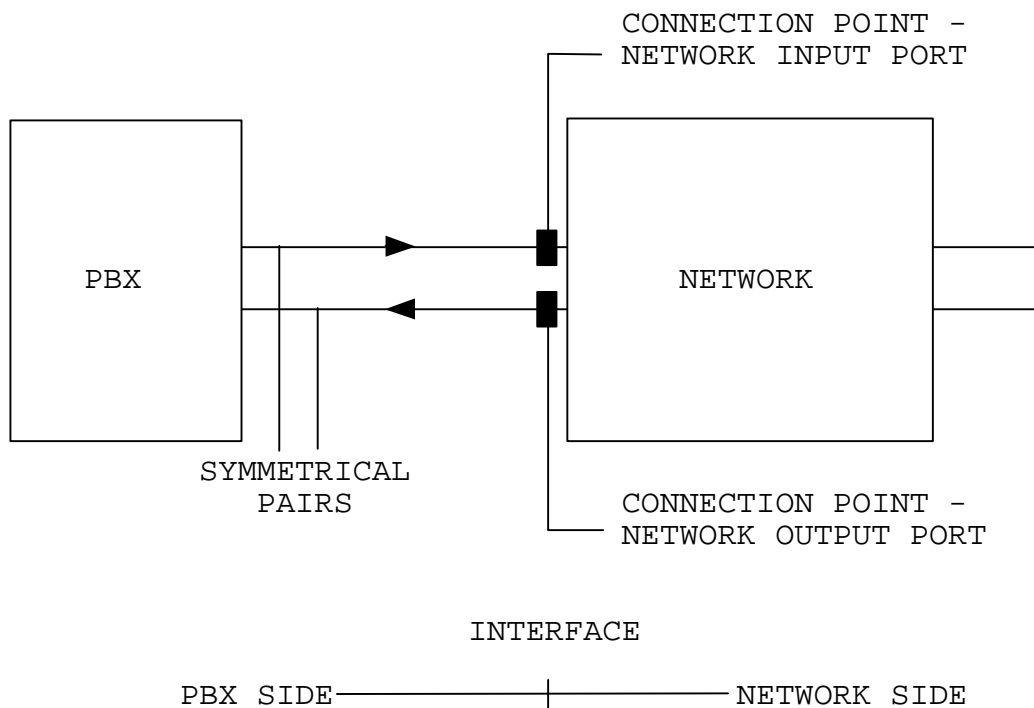

FIGURE 1: LOCATION OF THE CONNECTION POINTS AND INTERFACE

DIGITAL PRIVATE NETWORK SIGNALLING SYSTEM NO 1 (DPNSS 1)

SECTION 3 - DATA LINK LAYER (LEVEL 2)

CONTENTS

1	INTRODUCTION	Page 3
1.1	Data Link Layer (Level 2) For DPNSS 1	Page 3
1.2	The DPNSS 1 Data Link Protocol	Page 3
2	FRAME STRUCTURE AND CODING	Page 4
2.1	Frame Types	Page 4
2.2	Frame Structure	Page 4
2.3	Address Field	Page 5
2.3.1	Command/Response Bit	Page 6
2.3.2	Frame Group	Page 6
2.3.3	DLC Identification Number	Page 6
2.4	Control Field	Page 7
2.5	Information Field	Page 7
2.6	Frame Check Sequence	Page 7
3	FRAME TRANSMISSION	Page 9
3.1	General	Page 9
3.2	Flag Sequence	Page 9
3.3	Transparency	Page 9
3.4	Frame Abort Sequence	Page 9
3.5	Invalid Frames	Page 9
3.6	Busy	Page 10
4	DPNSS 1 DATA LINK SIGNALLING PROCEDURES	Page 11
4.1	Introduction	Page 11
4.2	Compelled Signalling	Page 11
4.2.1	Retransmission Limits	Page 11
4.2.2	Retransmission	Page 12
4.3	Level 1 Faults	Page 12
4.4	Signalling Procedures	Page 12
4.4.1	State Variables and Sequence Numbers	Page 12
4.4.2	Procedural States	Page 14
4.4.3	Procedural Errors	Page 14
4.4.4	Start-Up Procedures	Page 14
4.4.5	Resetting	Page 15
4.4.6	Information Transfer	Page 16
4.4.7	Test Frames	Page 18

5	INTERACTIONS OF DATA LINK LAYER WITH LEVELS 1 AND 3 ..	Page 19
5.1	Layer Service Primitives	Page 19
5.2	Requirements When Used On a 2048 kbit/s Digital Tie-Line	Page 19
5.2.1	Valid DLC/Channel Numbers	Page 19
5.2.2	DLC/Channel Provision on a Link	Page 20
5.3	Requirements When Used On a 1544 kbit/s Digital Tie-Line	Page 20
5.3.1	Valid DLC/Channel Numbers	Page 21
5.3.2	DLC/Channel Provision on a Link	Page 22
5.4	Requirements When Used On a Transmission System With a Low Speed Digital Interface	Page 22
5.4.1	Valid DLC/Channel Numbers	Page 22
5.4.2	DLC/Channel Provision on a Link	Page 22
6	SDL DESCRIPTION	Page 23
6.1	General	Page 23
6.2	Key to SDL Symbols	Page 24
Figure 1	- Receive Function	Page 27
Figure 2	- Transmit Function	Page 28
Figure 3	- Data Link Connection: Out of Service/Idle .	Page 30
Figure 4	- Data Link Connection: Reset Attempted	Page 31
Figure 5	- Data Link Connection: Reset Complete	Page 32
Figure 6	- Data Link Connection: Information Transfer	Page 33

HISTORY

Issue 1 - May 1983
Issue 2 - February 1984
Issue 3 - September 1984
Issue 4 - March 1986
Issue 5 - December 1989

Issue 6 - March 2001 - Specification renamed as DPNSS[188]

1 INTRODUCTION

1.1 DATA LINK LAYER (LEVEL 2) FOR DPNSS 1

The function of a DPNSS 1 Data Link Layer is to transfer information between two DPNSS 1 Level 3 entities (PBX Call Control), across a Level 1 interface, error free and in sequence, via a Common Signalling Channel (D-Channel).

A DPNSS 1 PBX shall support, as a minimum, the data link protocol described in the main body of this Section.

1.2 THE DPNSS 1 DATA LINK PROTOCOL

The main body of this Section specifies the structure of the frames, the format of fields, and elements of procedure for the DPNSS 1 Data Link Protocol.

All information that is carried on the D Channel is transmitted in HDLC format frames.

Within this Section the concept of a Data Link Connection (DLC) is used. A DLC can be considered as the Level 2 process that controls the transfer of Level 3 messages on behalf of one DPNSS 1 channel. A Data Link Layer may contain up to 60 DLCs ie it may support up to 30 Real channels and 30 Virtual Channels.

A Real Channel is a communication (traffic) channel which can be used to convey voice or data. A Virtual Channel is an information channel which has no physical realisation outside the D Channel.

Each DLC operates independently in parallel with other DLCs over the D-Channel. The DLCs are functionally independent and logically isolated from one another through the Data Link Layer addresses. The DLCs must be established, by performing the start-up procedures. Once a DLC is established Level 3 information can be transferred across it.

The DPNSS 1 Data Link Protocol is derived from Digital Access Signalling System No 2 (DASS 2) Section 3 (BTNR 190).

Subsection 2 defines the structure of the Data Link Layer frames.

Subsection 3 defines how frames are transmitted.

Subsection 4 defines the DPNSS 1 Data Link signalling procedures.

Subsection 5 defines the interactions between the DPNSS 1 Data Link Layer, the transmission facility (Level 1), and the Call Control layer (Level 3)

Subsection 6 contains an SDL description of the Data Link Signalling Procedure.

2 FRAME STRUCTURE AND CODING

All Data Link Layer control and information transfer is accomplished using frames. Frames are delimited on the physical media by a flag. A flag is a unique bit sequence (01111110). A frame is the data that occurs between two flags.

2.1 Frame Types

There are four types of DPNSS 1 Frame, two for controlling the link and two for conveying information, these are;

- Set Asynchronous Balanced Mode Restricted: SABMR
 An SABMR is used to initiate reset of a Data Link Connection.
- Unnumbered Acknowledgement: UA
 A UA is used to acknowledge an SABMR and to confirm that the Data Link Connection has reset.
- Unnumbered Information - Command: UI(C)
 A UI(C) is used to convey Level 3 messages
- Unnumbered Information - Response: UI(R)
 A UI(R) is used to confirm receipt of a UI(C)

2.2 Frame Structure

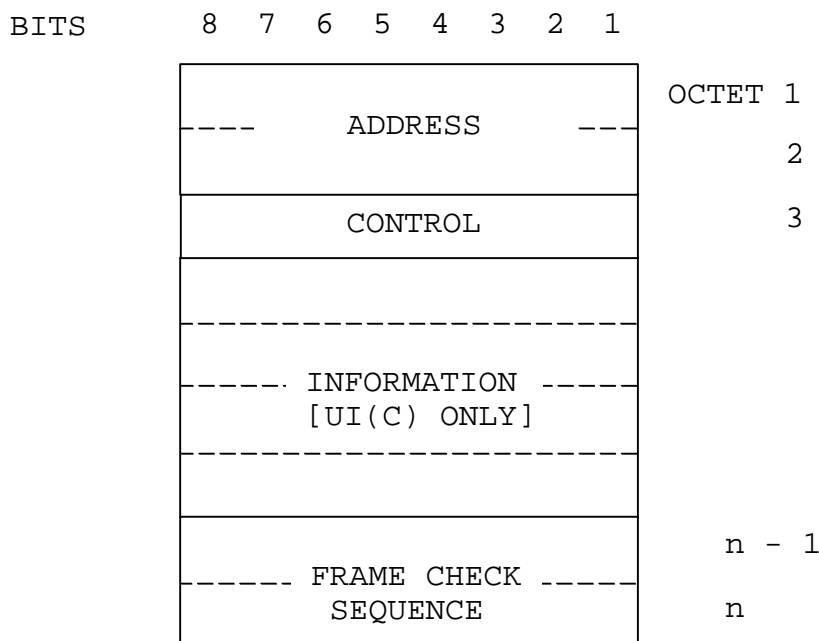

Figure 1: Frame Format

Fields within frames consist of multiples of 8 bits (octets). When octets are shown with their bits numbered, Bit 1 is the low order bit and Bit 8 is the high order bit.

2.3 ADDRESS FIELD

The Address Field consists of two octets. This field identifies the originator of a frame and whether it is a command or response. It also indicates the DLC with which the frame is associated. The structure of the Address Field is as follows.

NOTE: The two PBXs at each end of the transmission link shall be designated A and B by arrangement at configuration.

FIRST OCTET

8 7 6 5 4 3 2 1 BITS

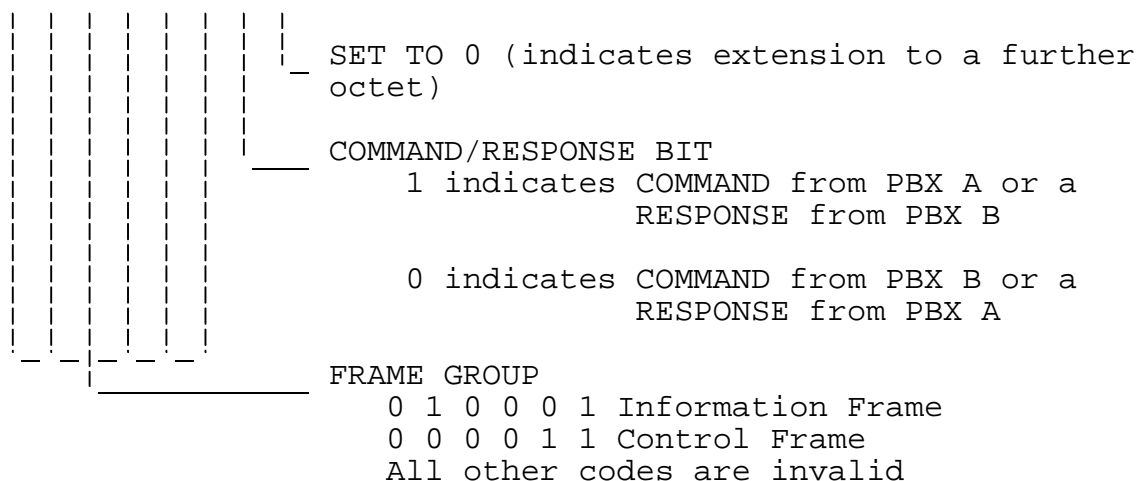

Figure 2a - Address Field Coding (First Octet)

The only valid bit combinations for the first octet of the address field are :-

8	7	6	5	4	3	2	1	BITS
0	0	0	0	1	1	0	0	SABMR from PBX B or UA from PBX A
0	0	0	0	1	1	1	0	SABMR from PBX A or UA from PBX B
0	1	0	0	0	1	0	0	UI(C) from PBX B or UI(R) from PBX A
0	1	0	0	0	1	1	0	UI(C) from PBX A or UI(R) from PBX B

SECOND OCTET

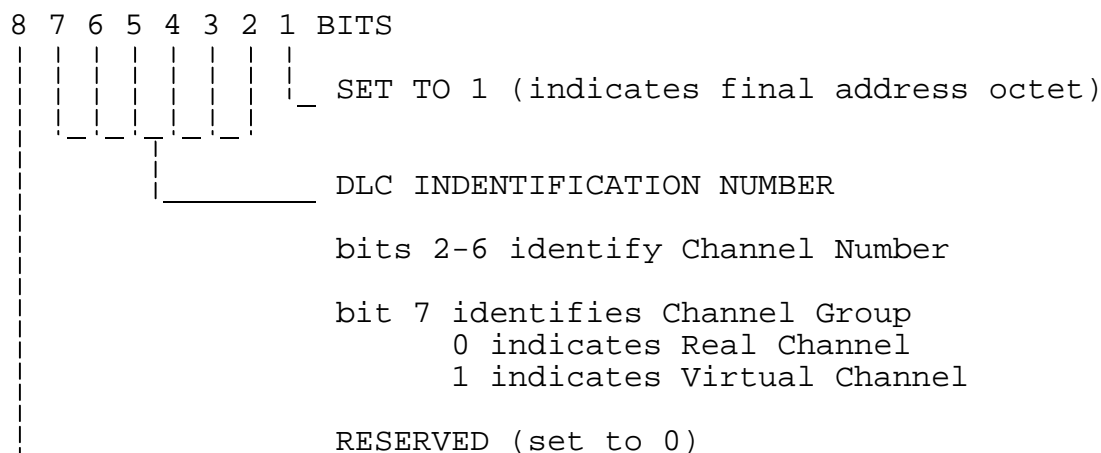

Figure 2b - Address Field Coding (Second Octet)

2.3.1 Command/Response Bit

A frame may be transmitted as either a command or a response, as indicated by the command/response bit within the address field. A command frame carries information or controls the link. A response frame acknowledges the receipt of a command frame.

The setting of the command/response bit is dependent upon whether the PBX is designated A or B. The settings are shown in Figure 2a.

2.3.2 Frame Group

The frame group indicates whether the frame is an information or control frame. Control frames are used to control the data link, ie by allowing it to be reset. Information frames carry information (ie Level 3 Message) and acknowledgements. The settings of this field are shown in Figure 2a.

2.3.3 DLC Identification Number

The DLC identification number identifies the data link connection (DLC), and hence the Real or Virtual Channel with which the Frame is associated.

The channel group indicates whether the DLC is associated with a Real or Virtual Channel. The channel number gives the number of the channel within the group.

The valid values for the channel number are dependent upon the type of physical link used. Subsection 5 contains the values that can be used on the different types of links that are detailed in SECTION 2.

2.4 CONTROL FIELD

The Control Field consists of one octet and contains a frame type code and sequence number information. It identifies the type of frame. The coding of the control field is shown below in Figure 3.

	BITS							
Frame Type	8	7	6	5	4	3	2	1
-----	-----							
UI(C) & UI(R)	0	0	0	N	0	0	1	1
SABMR	1	1	1	0	1	1	1	1
UA	0	1	1	0	0	0	1	1

Where N = Sequence Number of UI frames
(see 4.4.1)

Figure 3 - Control Field Coding

2.5 INFORMATION FIELD

The Information Field consists of an integral number of octets between 0 and 45 inclusive and is only present in UI(C) Frames. The Information Field is transferred transparently across the link. There is no Level 2 restriction or interpretation of the bit pattern contained in this field.

2.6 FRAME CHECK SEQUENCE

The FCS is a 16 bit field before the closing flag and is the cyclic redundancy check corresponding to the Address, Control and (if present) Information Fields calculated using the generator polynomial :-

$$x^{16} + x^{12} + x^5 + 1$$

as the ones complement of the sum (modulo 2) of :-

- a. The remainder of x^k ($x^{15} + x^{14} + \dots + x^2 + x + 1$) divided (modulo 2) by the generator polynomial, where k is the total number of bits in the Address, Control and Information Fields before bit stuffing for transparency; and
- b. the remainder after multiplication by x^{16} and then division (modulo 2) by the generator polynomial of the content of the Address, Control and Information Fields.

As a typical implementation at the transmitter, the remainder of the division may initially be preset to all 1's and then modified by division of the generator polynomial (as described above) of the Address, Control and Information Fields; the 1's complement of the resulting remainder is then transmitted as the 16 bit FCS.

At the receiver, if the initial remainder is preset to all 1's, the final remainder after multiplication by x to the power 16 and then division (modulo 2) by the generator polynomial of the serial incoming de-stuffed bits and the FCS will be 0001110100001111 (x to the power 15 through to x to the power 0 respectively) in the absence of transmission errors.

The coefficient of the highest-order terms of the FCS is transmitted first, i.e. the most significant of the 16 bits.

3 FRAME TRANSMISSION

3.1 GENERAL

Frames from each DLC shall be interleaved on the common signalling channel on a demand basis. It is recommended that DLCs are given cyclic access to the transmission facility. Consecutive frames must be separated by at least one flag.

Transmission of UI(C) frames may be delayed if a UI(R) frame needs to be transmitted.

With the exception of the frame check sequence (FCS) octets in a frame shall be transmitted in ascending order. Within an octet the bits shall also be transmitted in ascending order; ie bit 1 first, bit 8 last. The FCS is treated as a 16 bit field and the bits shall be transmitted in the opposite order; ie high order bit (bit 16) first, bit 1 last.

3.2 FLAG SEQUENCE

Frames shall be delimited by flags that consist of the 8 bit sequence 01111110. It is permissible to use a single flag as the delimiter between consecutive frames.

When no frame is being transmitted, flags (inter-frames time fill) shall be transmitted.

The flag preceding the Address Field is known as the opening flag and the flag following the FCS is known as the closing flag.

3.3 TRANSPARENCY

To preclude the simulation of a flag sequence by the contents of a frame a mechanism called zero bit insertion shall be used. To achieve transparency for these non flag-related sequences the transmitter examines the frame content including the Address, Control, Information (if present) and FCS fields and inserts a 0 after all sequences of 5 contiguous 1 bits. This ensures that the flag sequence is not simulated. At the receiving end, the incoming frames are examined and any 0 bit directly following 5 contiguous 1 bits is discarded.

3.4 FRAME ABORT SEQUENCE

A sequence of seven or more contiguous ones following a zero shall be recognised as an abort sequence. On receipt of an abort signal, any incoming frame shall be ignored and discarded.

3.5 INVALID FRAMES

Frames that are too short (shorter than 5 octets between flags), or too long (greater than 50 octets between flags), or contain a FCS error shall be considered invalid and discarded.

3.6 BUSY

No mechanism is provided for a PBX to indicate its temporary busy condition to the remote PBX, ie when a PBX is unable to respond immediately to a received UI(C) frame.

4 DPNSS 1 DATA LINK SIGNALLING PROCEDURES

4.1 INTRODUCTION

The DPNSS 1 Data Link signalling procedures include error checking and retransmission of frames to provide error free sequenced transmission of Level 3 information across one DLC via the D-Channel.

The signalling procedures operate independently for each Level 2 address, DLC, that is supported; i.e. each DLC has it's own state variables and the state of one DLC is independent of all others.

Frames from each DLC are interleaved on the signalling channel on a demand basis. It is recommended that DLCs are given cyclic access to the transmission facility. Consecutive frames must be separated by at least one flag.

4.2 COMPELLED SIGNALLING

DPNSS 1 Data Link Signalling procedures require that each command frame is transmitted repeatedly until it is acknowledged by the appropriate response frame or the retransmission limits are exceeded. This technique is termed "Compelled Signalling".

The acknowledgement to a SABMR frame is an UA frame. The acknowledgement to an UI(C) frame is an UI(R) with a receive sequence number N(R) matching the send sequence number N(S) of the UI(C).

Transmission of UI(C) frames may be delayed through the need to send an UI(R) frame prior to sending an UI(C) frame. Transmission may also be delayed due to transmission of frames associated with other DLCs.

4.2.1 Retransmission Limits

There are three retransmission limit parameters, namely:

- a) NL - The minimum retransmission count limit is the minimum number of retransmissions of a command frame which must take place if the correct acknowledgement is not received. NL is recommended to be 64.
- b) NT1 - The minimum retransmission period is the minimum period of time for which a command frame must be retransmitted if not acknowledged. NT1 shall be 500ms.
- c) NT2 - The minimum post retransmission acknowledgement delay, is a minimum period of time after the expiry of NL and NT1 during which an acknowledgement shall be awaited before reporting a retransmission failure to Level 3. When DPNSS 1 is used via a satellite link NT2 shall be 520ms, otherwise it shall be 0.

4.2.2 Retransmission

Command frames are retransmitted until one of the following conditions is met :-

- 1) The correct acknowledgement frame is received.
- 2) The retransmission limit, NL, and the retransmission period, NT1 are exceeded (see 4.2.1).

NOTE: Both limits must be exceeded. If after NT1 less than NL retransmissions have occurred, retransmission shall continue until NL is reached. If NL retransmissions occur before NT1, retransmission shall continue until NT1.

- 3) A reset occurs.

If condition 2 is met and after a further delay, NT2, a correct acknowledgement has still not been received then Level 3 shall be informed of a fault condition and the DLC shall be reset as described in 4.4.5.1. During the period NT2 the continued retransmission of frames is optional.

4.3 LEVEL 1 FAULTS

It is recommended that following the detection of a Level 1 (link) fault the link is reset at Level 2, using the start-up procedures described in 4.4.4. The DLCs may remain in the "Out Of Service" state until the detected Level 1 faults have cleared.

Recovery from a link fault may be initiated by Level 3 or 2.

4.4 SIGNALLING PROCEDURES

4.4.1 State Variables and Sequence Numbers

To control the transfer of information, the PBX maintains two operational values, called state variables. The sequence numbers of the received UI frames are checked against these state variables to determine the appropriate action. There is one set of variables for each DLC.

All numbers can only take values in the range 0 to 1. Thus all arithmetic using them is performed modulo 2.

4.4.1.1 SEND STATE VARIABLE V(S)

The send state variable V(S) records the sequence number of the next UI(C) frame to be transmitted. It is incremented by 1 (modulo 2) when an UI(R) frame containing a receive sequence number N(R) equal to V(S) is received as an acknowledgement to a transmitted UI(C) frame. V(S) is set to zero (0) following a reset.

4.4.1.2 RECEIVE STATE VARIABLE V(R)

The receive state variable V(R) records the sequence number of the next UI(C) frame expected. When an UI(C) frame is received with N(S) equal to V(R) and is acknowledged by the sending of a UI(R), then V(R) is incremented by 1 (modulo 2). V(R) is set to zero (0) following a reset.

4.4.1.3 SEND SEQUENCE NUMBER N(S)

The send sequence number N(S) is the sequence number sent in an UI(C) frame. N(S) is set equal to the value of the send state variable V(S) before transmission of an UI(C) frame.

4.4.1.4 RECEIVE SEQUENCE NUMBER N(R)

The receive sequence number N(R) is the sequence number sent in an UI(R) frame. N(R) is set equal to the value of the receive state variable V(R) before transmission of a UI(R) frame.

4.4.2 Procedural States

A data link connection has five defined states, an overview of transitions between these states is shown in Figure 4. The state of one DLC is independent of the state of any other DLC.

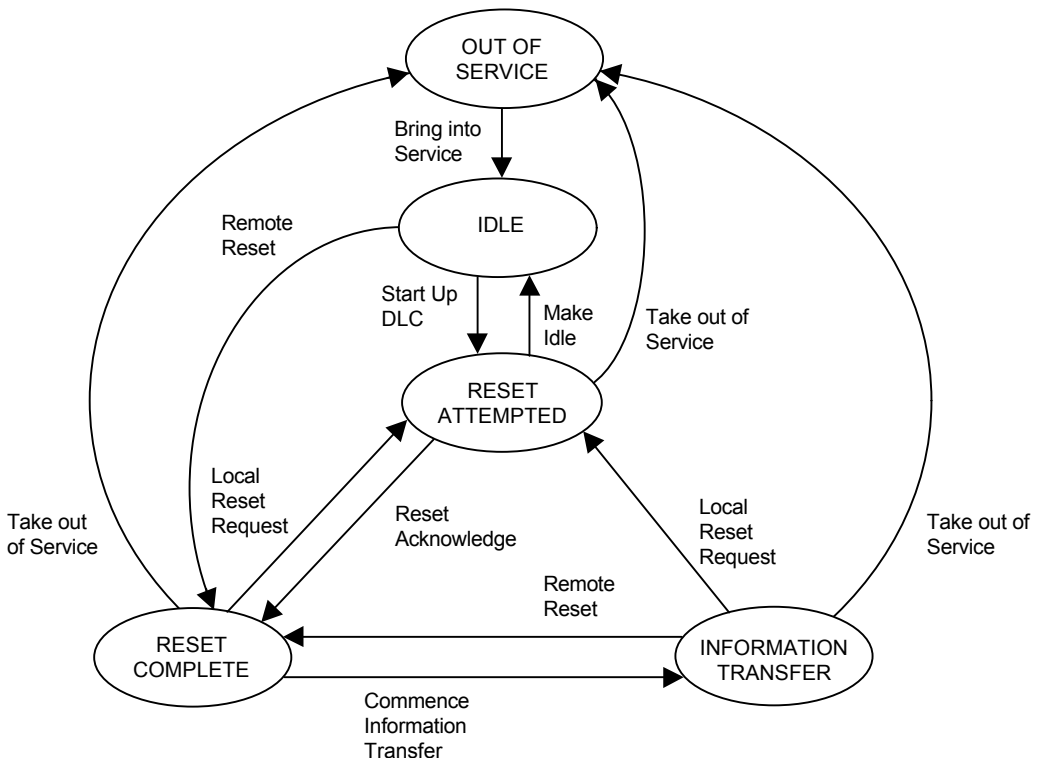

Figure 4: STATES AND TRANSITIONS OF DPNSS 1 LEVEL 2

4.4.2.1 OUT OF SERVICE

This state can be entered immediately following power up or due to a maintenance action, eg. following reset failure. It is the state in which all DLCs exist before activation of the Data Link Layer. A DLC remains in the 'Out of Service' state if it is not being used across a particular physical link. In this state all received frames are ignored.

4.4.2.2 IDLE

This is the state which a DLC enters from the Out of Service state while awaiting to be started. In this state reset requests from the remote PBX are not ignored, as in the Out of service state. If a DLC is reset remotely the local data link layer does not need to reset it. When a DLC is started up locally it moves from this state to Reset Attempted.

4.4.2.3 RESET ATTEMPTED

This is the state which a DLC enters when a reset request is sent on it. The DLC enters the Reset Complete state on completion of the reset procedure.

4.4.2.4 RESET COMPLETE

This is the state of a DLC which has just been successfully reset. In this state, all the state variables are set to 0.

4.4.2.5 INFORMATION TRANSFER

This is the state in which a DLC exists for the sending and receiving of UI frames.

4.4.3 Procedural Errors

Unless otherwise specified in this section, frames or signals received by a PBX, which do not conform to the appropriate formats or procedures specified, are considered to be invalid and shall be discarded and ignored by the PBX.

4.4.4 Start-Up Procedures

When a DPNSS 1 link is being brought into service, each DLC is reset individually. Multiple DLCs may be brought into service in two ways, simultaneously or in sequence. Communicating PBXs are not constrained to use the same method.

Start-up Method 1: All DLCs are reset simultaneously

The PBX does not wait for one DLC to reset before initiating the resetting of all the others. A local reset, as described in 4.4.5.1, is initiated on all DLCs at the same time. Start up is complete when each supported DLC has been successfully reset or has had a reset failure. In this method DLCs do not remain in the Idle state but are all driven into the Reset Attempted state immediately from the Out Of Service state.

Start-up Method 2 : Each DLC Reset in sequence

On start up all DLCs enter the Idle state. A local reset, as described in 4.4.5.1, is initiated on one DLC and an acknowledgement awaited before the next DLC is dealt with. On reset completion or failure the next DLC is dealt with. This procedure continues until all the DLCs have been dealt with. If a remote reset occurs on a DLC in the Idle state it is considered as being successfully reset and can be bypassed in the start-up procedures.

4.4.5 Resetting

A DLC may be reset by the local or remote PBX by use of the SABMR frame. A DLC should only be reset when brought into service or to recover from a fault condition, otherwise it may result in loss of information. DLCs can be reset independently of each other.

When a DLC is reset the decision to clear any call using the associated channel is a matter of PBX design. If a call is cleared for this reason then it must be cleared using the normal Level 3 procedures (see SECTION 5).

4.4.5.1 Locally Initiated Reset

To reset a DLC any frame which is currently being (re)transmitted is discarded, and a SABMR command frame is sent. The DLC then enters the "Reset Attempted" state. The SABMR is retransmitted, as described in 4.2 until an acknowledgement is received or the retransmission limits are reached. An UA response frame is the acknowledgement. If the SABMR is acknowledged correctly the associated state variables V(S) and V(R) are set to zero. The DLC then enters the "Reset Complete" state.

If the retransmission limits are reached, Level 3 shall be informed of the fault and retransmission shall continue until an acknowledgement is received. When there is a reset failure Level 3 may put the DLC into the Out of Service or Idle state.

4.4.5.2 Remotely Initiated Reset

If a SABMR is received the associated state variables V(S) and V(R) are reset to 0, any frame currently being (re)transmitted on the DLC is discarded and an UA response frame is sent. The DLC then enters the Reset Complete state.

4.4.5.3 Simultaneous Reset

If the DLC is in the Reset Attempted state (ie, the local PBX has itself sent a SABMR) when a SABMR is received, it may be considered as an acknowledgement. If it is considered as an acknowledgement, the transmission of SABMRs ceases, a UA response frame is returned and the associated state variables V(R) and V(S) are reset to 0. The DLC then enters the Reset Complete state. If the SABMR is not considered as an acknowledgement, a UA response frame is returned, but the transmission of SABMRs continues and the DLC remains in the Reset Attempted state.

4.4.6 Information Transfer

Transfer of Level 3 information between PBXs is accomplished by the exchange of UI(C) and UI(R) frames carrying information and acknowledgements respectively. An UI(C) frame is transmitted repeatedly as described in 4.2.

Information transfer may only occur on a DLC once it has been successfully reset. A DLC enters the Information Transfer state on acceptance of information to be transmitted from level 3 or receipt of a valid UI(C) frame, either of which may occur in the Reset Complete state. Information can only be transmitted in the Information Transfer state.

Only one information frame, UI(C), may be unacknowledged at any one time on any one DLC. Thus a new UI(C) frame may not be transmitted until any current UI(C) frame on the same DLC is acknowledged or a reset occurs, as described in 4.2.

4.4.6.1 Sending Information

When there is no unacknowledged UI(C) frame outstanding on a DLC, user information from Level 3 can be accepted for transfer. The Level 3 message for transmission is inserted into the Information Field of a UI(C) frame with N(S) being set to equal the current value of V(S). The UI(C) frame is then transmitted as described in 4.2.

If the expected UI(R) response frame, i.e. one in which N(R) equals V(S), is received the UI(C) frame is assumed to have been accepted by the remote PBX. V(S) is incremented by 1 (modulo 2) and the next message can be accepted from Level 3 for transfer.

If the retransmission limits are exceeded the PBX initiates the reset of the DLC as described in 4.4.5.1.

4.4.6.2 Receiving Information

When the PBX receives an UI(C) frame with a valid Address (see 2.3), i.e. on a DLC that is supported and has been successfully reset, the size of the Information Field is checked. If the Information Field length is greater than 45 octets the frame is invalid and is ignored.

If the address and information fields are valid the send sequence number, N(S) is checked. The value of N(S) should equal the current value of V(R).

If N(S) is correct the capability to pass the information from the Information Field of the UI(C) frame to Level 3 is investigated. If it is not possible the frame is ignored and discarded. Otherwise the Information Field of this frame is passed to Level 3, the received state variable V(R) is incremented by 1 (modulo 2), and an acknowledgement is sent as described in 4.4.6.3. If the DLC is in the Reset Complete state it enters the Information Transfer state following transfer of the information to level 3.

If an UI(C) frame is received with a valid Address Field and length but with an N(S) that is incorrect, i.e. it is not equal to V(R), the Information Field is discarded and V(R) is not updated. If the DLC is in the Information Transfer state an acknowledgement is sent as described in 4.4.6.3. If the DLC is in the Reset Complete state no acknowledgement is sent and the UI(C) is ignored and discarded.

NOTE: An information field of length 0 is valid. In this case there is no information to be passed to layer 3 and the check on the capability of passing the information may be omitted but in all other respects the frame is processed as described above. Zero length information fields may be used for testing purposes as described in 4.4.7.

4.4.6.3 Sending Acknowledgement

Whenever an UI(C) frame is to be acknowledged an UI(R) frame is sent at the earliest opportunity containing a N(R) equal to the N(S) contained in the UI(C) frame.

The (re)transmission of an UI(C) frame is not initiated when an UI(R) frame is available to be sent on the same DLC.

4.4.6.4 Receiving Acknowledgement

If an UI(R) frame is received with a valid Address Field the N(R) is checked. If N(R) is equal to V(S), the associated UI(C) frame is considered as having been successfully transferred. V(S) is then incremented by 1 (modulo 2).

If N(R) is not equal to V(S), the UI(R) frame is discarded and ignored.

UI(R) frames are valid only in the Information Transfer state. In any other state they shall be discarded.

NOTE: If a valid UI(R) frame is received with an Information Field of greater than 0 octets, the frame may be accepted with the information field being discarded, or the entire frame discarded and ignored (i.e. V(S) not updated).

4.4.7 Test Frames

As a PBX option NULL UI(C) frames (i.e. UI(C) frames with a zero length information field) may be sent periodically to determine whether any DLC is functioning correctly. The normal retransmission and recovery procedures apply to these frames.

If a NULL UI(C) frame is unacknowledged after the normal retransmission limits the DLC is reset as specified in 4.2.

If test frames are used they should be transmitted no more frequently than once every five minutes on each DLC.

5 INTERACTIONS OF THE DATA LINK LAYER WITH LAYERS 1 AND 3

5.1 LAYER SERVICE PRIMITIVES

Although an implementation matter, it is recommended that explicit mechanisms are provided to convey :-

- Indication from Level 1 to Level 2 that a loss of synchronisation (due to line break or line failure) has occurred.
- Request for DLC reset from Level 3 to Level 2.
- Indication of DLC reset from Level 2 to Level 3.
- Request for DLC status from Level 3 to Level 2.
- Indication of DLC status from Level 2 to Level 3.
- Request from Level 3 to Level 2 to transmit information.
- Indication from Level 2 to Level 3 of successful information transmission
- Indication of failure to reset from Level 2 to Level 3.

5.2 REQUIREMENTS WHEN USED ON A 2048 kbit/s DIGITAL TIE-LINE

This section describes the requirements placed on the DPNSS 1 Data Link Layer when the physical line is a 2048 kbits/s Digital Transmission Tie-Line. The interface of this physical line is defined in SECTION 2, ANNEX 1.

The 2048 kbit/s transmission link provides 32 timeslots each with a bandwidth of 64kbit/s. Timeslot 0 is used for frame-alignment. Timeslot 16 is the Signalling Channel and is used to carry the DPNSS 1 Common-Channel Signalling. The other 30 timeslots (1 to 15 and 17 to 31) are known as Traffic Channels and carry voice or data traffic.

The Traffic Channels are controlled by the DPNSS 1 Signalling on timeslot 16.

5.2.1 Valid DLC/Channel Numbers

Up to 30 Real and 30 Virtual channels can be supported on a 2048 kbits/s link. These are identified with channel numbers 1 to 15, 17 to 31. DLCs for Real channels (1 to 15 and 17 to 31) carry signalling for the Traffic channels carried in the corresponding timeslots on the digital link. DLCs for Virtual channels (1 to 15 and 17 to 31) have no corresponding Traffic channels.

A channel number of 0 is invalid. If a frame is received with this channel number it is treated as being invalid.

A channel number of 16 indicates the signalling channel. It may be used during start-up; however it should be noted that some PBXs may not acknowledge a SABMR with this address but simply discard it.

5.2.2 DLC/Channel Provision on a Link

All 30 Real and 30 Virtual Channel DLCs must be provided by both PBXs, unless agreement is reached between both PBX suppliers and owners to configure a lesser number.

Where a lesser number is configured, the same number of Virtual Channel DLCs as Real Channel DLCs shall be supported, using the same range of numbers for both groups, unless agreement is reached between the PBX suppliers and owners to configure a different arrangement.

Where less than 30 Real or 30 Virtual Channels are configured, they shall be numbered consecutively from 1 in the range 1-15, 17-31, unless agreement is reached between the PBX suppliers and owners to configure a different arrangement.

If the DLC associated with a timeslot (traffic channel) is not configured, then the corresponding traffic channel shall not be considered as a DPNSS 1 channel under control of timeslot 16 of the same physical line. Any usage of a channel whose DLC in timeslot 16 is not configured shall be by agreement between the suppliers and owners involved, but if agreement cannot be reached it shall not be used.

If a traffic channel is configured as being not under control of timeslot 16 of the same physical line, then the associated DLC in timeslot 16 shall not be configured.

DLCs that are not configured shall remain in the Out of Service state.

5.3 REQUIREMENTS WHEN USED ON A 1544 kbit/s DIGITAL TIE-LINE

This section describes the requirements placed on the DPNSS 1 Data Link Layer when the physical line is a 1544 kbit/s Digital Transmission Tie-Line. The interface of this physical line is defined in SECTION 2 ANNEX 4.

The 1544 kbit/s transmission link uses 8 kbit/s for frame-alignment, leaving 1536 kbit/s for signalling and traffic. This 1536 kbit/s provides 24 timeslots each with a bandwidth of 64 kbit/s. Timeslot 24 is the Signalling Channel and is used to carry the DPNSS 1 Common-Channel Signalling. The other 23 timeslots (1 to 23) are known as Traffic Channels. These Traffic Channels are controlled by the DPNSS 1 Signalling on timeslot 24.

5.3.1 Valid DLC/Channel Numbers

Up to 23 Real and 23 Virtual-Channel DLCs can be supported on a 1544 kbit/s link. These are identified with channel numbers 1 to 23. Real-Channel DLCs, 1-23, carry signalling for the Traffic channels carried in the corresponding timeslots on the digital link. Virtual-Channel DLCs have no corresponding Traffic channels.

A channel number of 0 is invalid. If a frame is received with this channel number it is treated as being invalid.

A channel number of 24 indicates the signalling channel. It may be used during start-up; however, it should be noted that some PBXs may not acknowledge a SABMR with this address but simply discard it.

5.3.2 DLC/Channel Provision on a Link

All 23 Real and 23 Virtual Channel DLCs must be provided by both PBXs unless agreement is reached between both PBX suppliers and owners to configure a lesser number.

Where a lesser number is configured the same number of Virtual-Channel DLCs as real channel DLCs shall be supported, using the same range of numbers for both groups, unless agreement is reached between the PBX suppliers and owners to configure a different arrangement.

Where less than 23 Real or 23 Virtual Channels are configured, they shall be numbered consecutively from 1 in the range 1-23, unless agreement is reached between the PBX suppliers and owners to configure a different arrangement.

If the DLC associated with a timeslot (traffic channel) is not configured, then the corresponding traffic channel shall not be considered as a DPNSS 1 channel under control of timeslot 24 of the same physical line. Any usage of a channel whose DLC in timeslot 24 is not configured shall be by agreement between the suppliers and owners involved, but if agreement cannot be reached it shall not be used.

If a traffic channel is configured as being not under control of timeslot 24 of the same physical line, then the associated DLC in timeslot 24 shall not be configured.

DLCs that are not configured shall remain in the Out of Service state.

5.4 REQUIREMENTS WHEN USED ON A TRANSMISSION SYSTEM WITH A V-SERIES OR X-SERIES DIGITAL INTERFACE

This section describes the requirements placed on the DPNSS 1 Data Link Layer when used on a transmission link conforming to either of the interfaces defined in SECTION 2, ANNEXES 2 and 3 of this specification.

Such a transmission link purely provides the Common-Channel Signalling. The traffic circuits to be associated with the signalling channel may not be associated with any other signalling channels. Which traffic circuits are to be associated with a given signalling channel is a matter for agreement between suppliers and owners.

The allocation of DLC identifiers on a signalling channel to associated traffic circuits must be agreed by suppliers and owners and configured identically at the PBXs between which the signalling channel and its associated traffic circuits are connected.

5.4.1 Valid DLC/Channel Numbers

Up to 30 Real and 30 Virtual-Channel DLCs can be supported on a low speed digital link. These are identified with channel numbers 1 to 15, 17 to 31. Real-Channel DLCs 1 to 15 and 17 to 31 carry signalling for the Traffic channels carried in the associated physical circuits. Virtual-Channel DLCs 1 to 15 and 17 to 31 have no corresponding Traffic channels.

A channel number of 0 is invalid. If a frame is received with this channel number it is treated as being invalid.

A channel number of 16 indicates the signalling channel. It may be used during start-up; however, it should be noted that some PBXs may not acknowledge a SABMR with this address but simply discard it.

5.4.2 DLC/Channel Provision on a Link

The same number of Real-Channel DLCs as there are traffic circuits associated with the signalling channel must be supported by both PBXs. The Real-Channel DLCs shall be numbered consecutively from 1 in the range 1-15, 17-31, unless agreement is reached between PBX suppliers and owners to configure a different arrangement.

The same number of Virtual-Channel DLCs as Real-Channel DLCs shall be supported, using the same range of numbers for both groups, unless agreement is reached between the PBX suppliers and owners to configure a different arrangement, either in terms of the number of Virtual-Channel DLCs or the numbering of them.

6 SDL DESCRIPTION

6.1 GENERAL

6.1.1 The SDL diagrams included in this specification are to assist in the understanding of the technical text, and must only be used in association with the text.

The SDL diagrams are for explanation and overall functional specification only and are not intended to show the required method of realising DPNSS 1. However overall functional compliance with the SDL must be achieved.

6.1.2 For the purpose of SDL representation a PBX is considered to comprise a number of interacting but separate processes; Figure 5 shows the Level 2 processes.

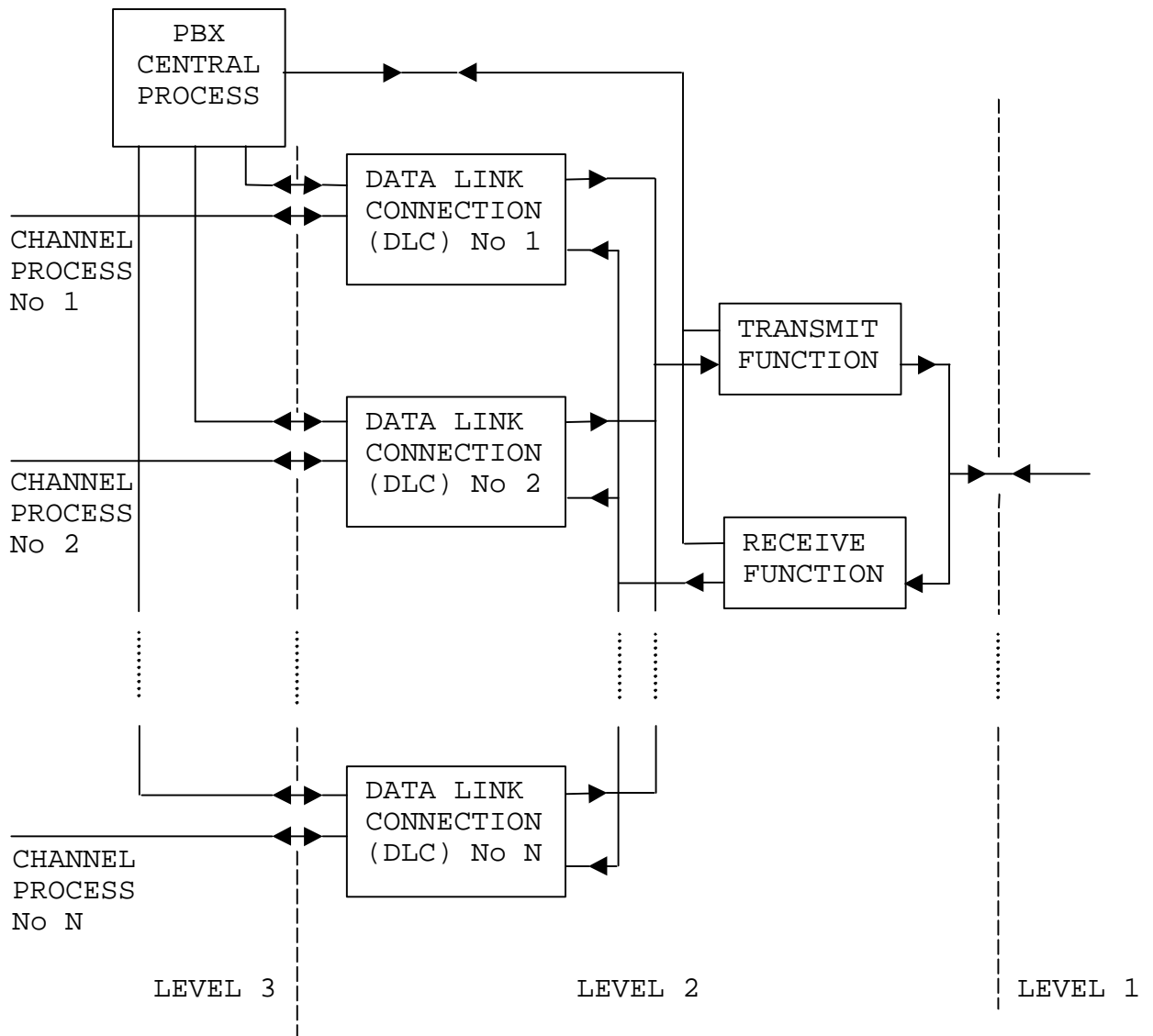

Figure 5

The DPNSS 1 Data Link Connection (DLC), Transmit Function and Receive Function represent the DPNSS 1 Level 2 requirements. The PBX Central Process is not part of DPNSS 1 and although its internal procedures are implied within this specification they are not specified in detail.

6.1.3 The Data Link Connection (DLC) deals with the procedures that are detailed in Subsection 4 of this Section. eg the control of information transfer. There is one DLC associated with every DPNSS 1 Channel including Virtual Channels.

6.1.4 The Transmit (TX) and Receive (RX) Functions perform the bit-by-bit construction, transmission, reception and FCS verification of individual Frames. The TX and RX Functions also deal with the sending and reception of Flags. There is one TX and RX Function associated with one DPNSS 1 Signalling Channel, ie up to 60 DLCs.

6.1.5 The Level 3 processes (eg Channel Process) are described in SECTION 5 of this specification.

6.2 Key To SDL Symbols

6.2.1 This Subsection details the SDL symbols and conventions used to describe the following DPNSS 1, Level 2 processes:

- Data Link Connection
- TX Function
- RX Function

6.2.2 It should be noted that on the SDL diagrams shown in this Section the messages from Level 1 always arrive from the right and the messages from Level 3 always arrive from the left regardless of the direction of the call or whether the PBX is originating or terminating.





6.2.3 When passing information to Level 2 from Level 3 it is assumed within the Level 3 SDL that Level 2 is capable of handling all messages presented to it. The procedures for handling failure between Levels 2 and 3 are PBX dependent and not shown in this specification.

6.2.4 Where timeouts are given on the SDL diagrams only the nominal timeout value is shown, the tolerance is given in the textual description.

6.2.5 The SDL diagrams shown in this specification are based on CCITT Recommendations Z.101, Z.102 and Z.104.

6.2.6 A short textual description is given against each SDL symbol in the following table.

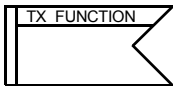
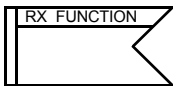
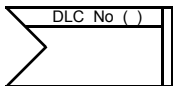
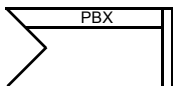
SDL SYMBOLS USED FOR LEVEL 2 DESCRIPTION IN DPNSS[188]

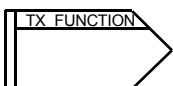
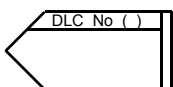
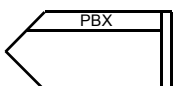
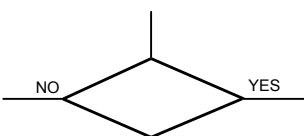
1		The TX Function, RX Function or DLC awaiting instructions
2		An input from Level 1 to the RX Function
3		An input from the TX Function to a DLC
4		An input from the RX Function to a DLC
5		An input from DLC No () to the TX Function
6		An input from the PBX Central Process to the RX Function, TX Function or a DLC
7		An output to Level 1 from the TX Function
8		An output to the TX Function from a DLC
9		An output to a DLC from the TX Function or a RX Function
10		An output to the PBX Central Process from the TX Function, RX Function or a DLC
11		A decision symbol. This symbol may occur in the TX Function, RX Function or a DLC. The knowledge to make the decision within the symbol is assumed to be available. Any interchange of signals between different processes or functions to obtain the information is not shown on the SDL diagrams.

SDL SYMBOLS USED FOR LEVEL 2 DESCRIPTION IN DPNSS[188]

12

BUFFERS OCCUPIED				
SABMR	1	0	0	0
UA	-	1	0	0
UI(C)	-	-	1	0
UI(R)	-	-	-	1

A decision table is similar to the diamond but can show relationship between more than one decision.

1 means the condition is true
0 means the condition is false
- means the condition is unimportant

The knowledge to make the decision within the symbol is assumed to be available. Any interchange of signals between different processes or functions to obtain the information is not shown on the SDL diagrams.

13

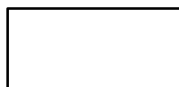

A task to be carried out by the PBX.

14

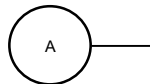

Continuation within the same figure to another sheet.

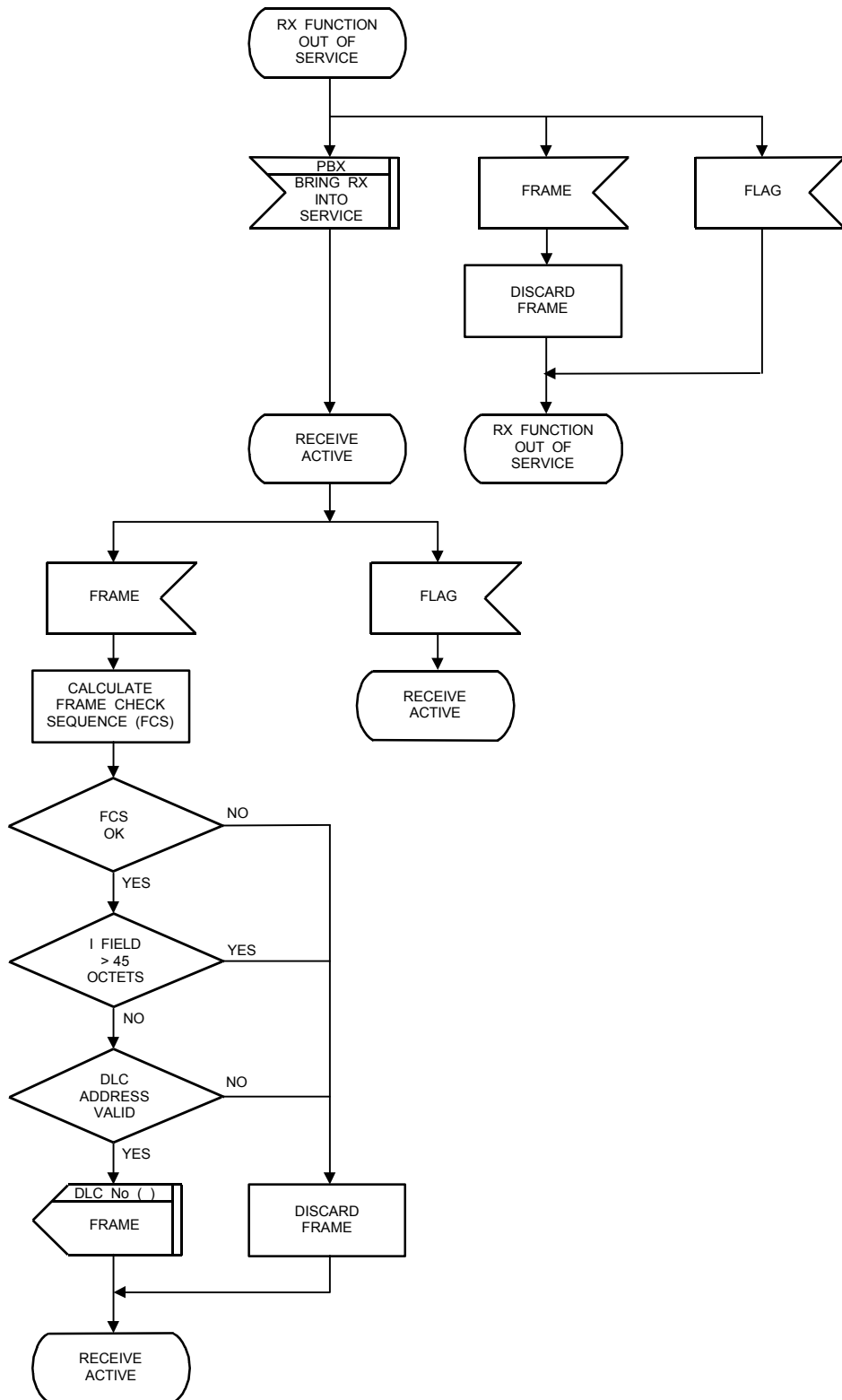

DPNSS 1 LAYER 2:
RECEIVE FUNCTION
FIG.1 (DPNSS[188] SECTION 3)

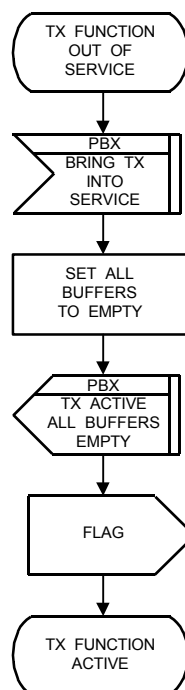

DPNSS LAYER 2:
TRANSMIT FUNCTION
FIG.2 (DPNSS[188] SECTION 3) SHEET 1 OF 2

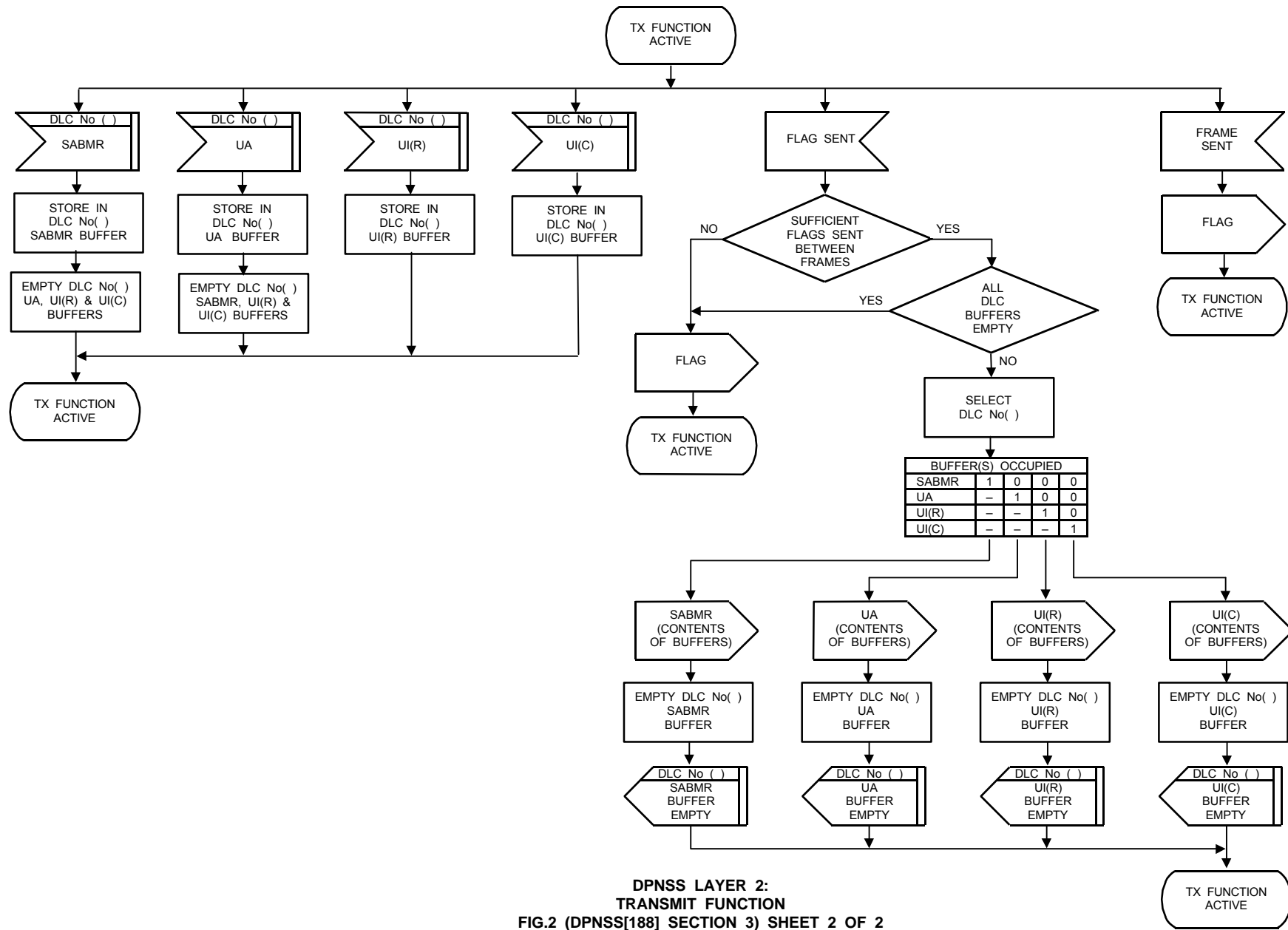

DPNSS LAYER 2:
TRANSMIT FUNCTION
FIG.2 (DPNSS[188] SECTION 3) SHEET 2 OF 2

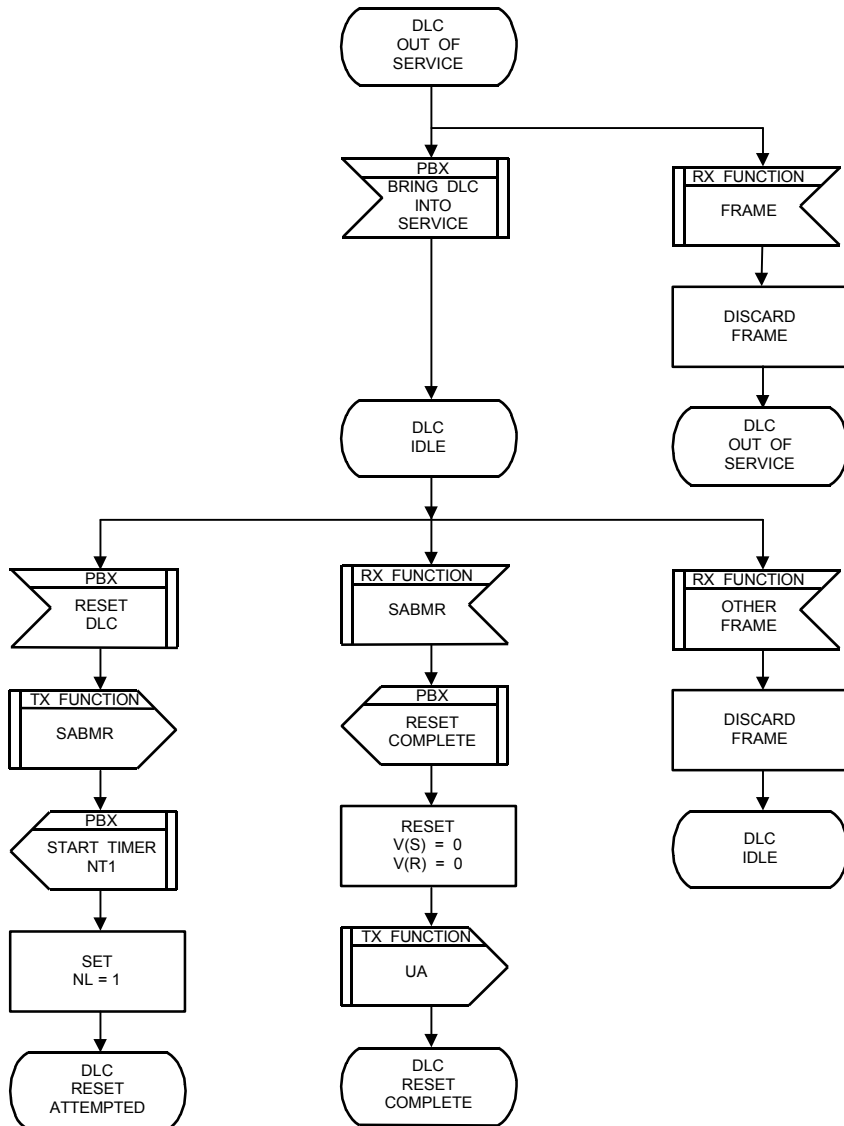

DPNSS 1 LAYER 2:
DATA LINK CONNECTION OUT OF SERVICE / IDLE
FIG.3 (DPNSS[188] SECTION 3)

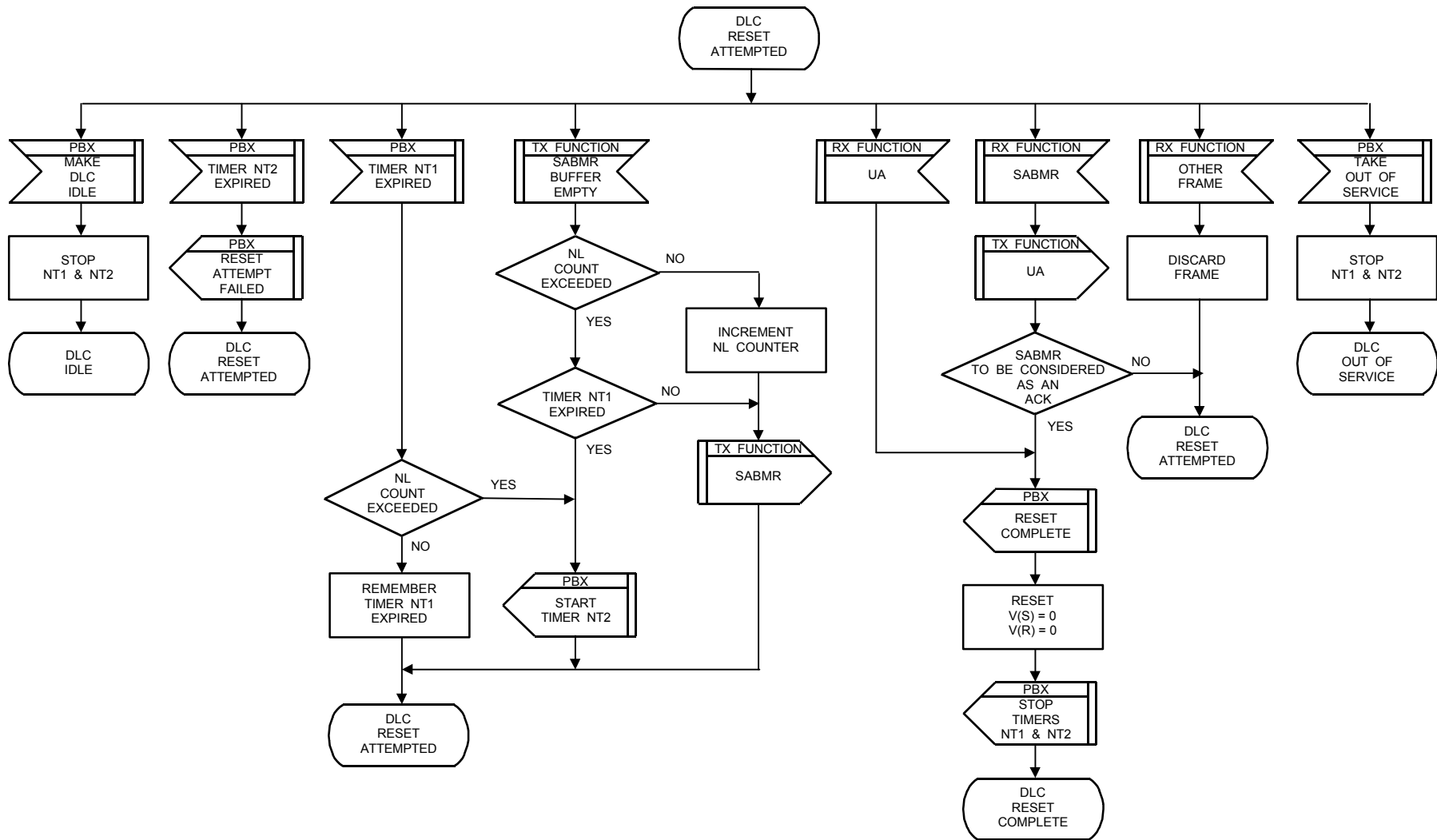

DPNSS 1 LAYER 2:
DATA LINK CONNECTION (DLC) RESET ATTEMPTED
FIG.4 (DPNSS[188] SECTION 3)

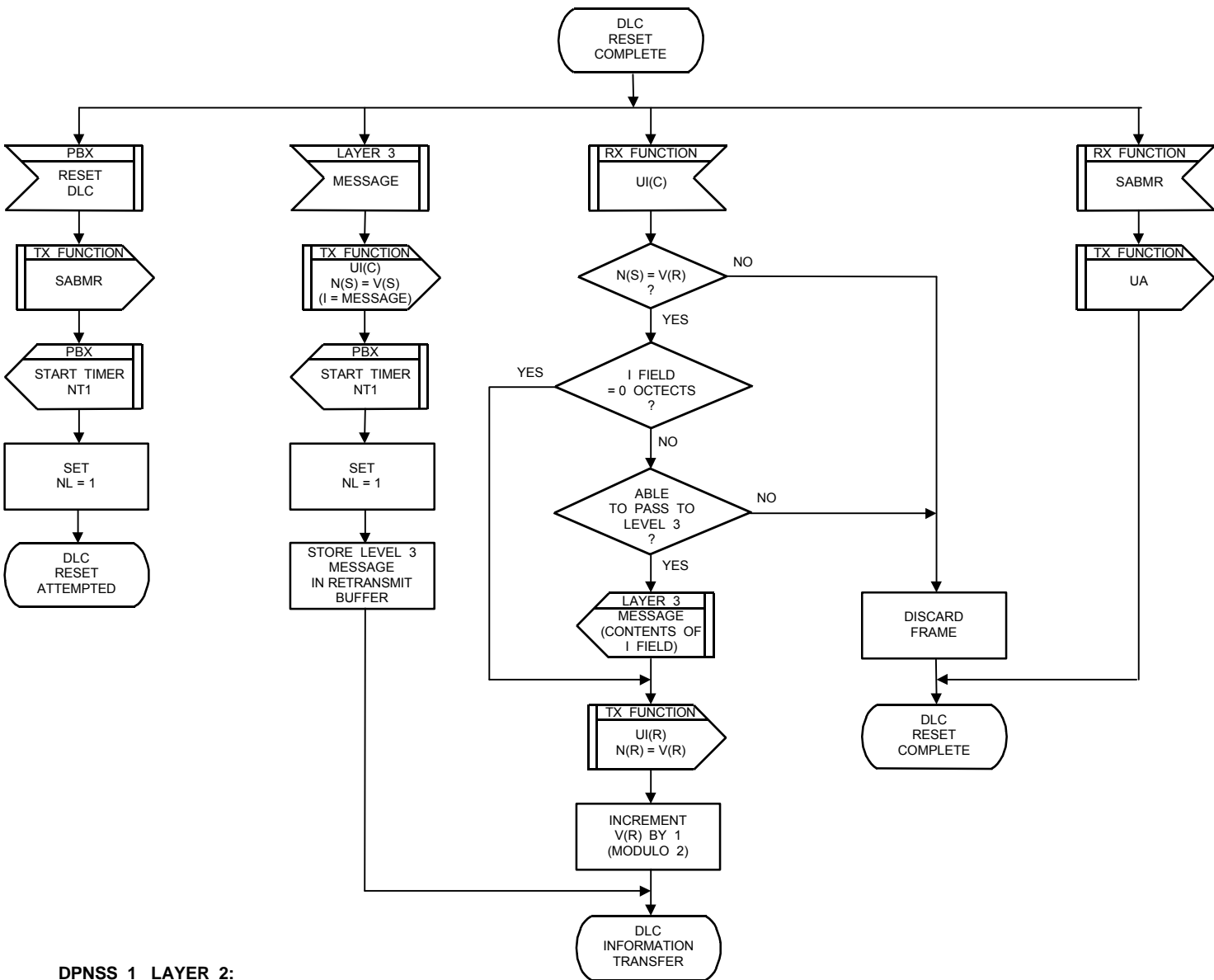

DPNSS 1 LAYER 2:
CONNECTION (DLC) RESET COMPLETE
FIG.5 (DPNSS[188] SECTION 3)

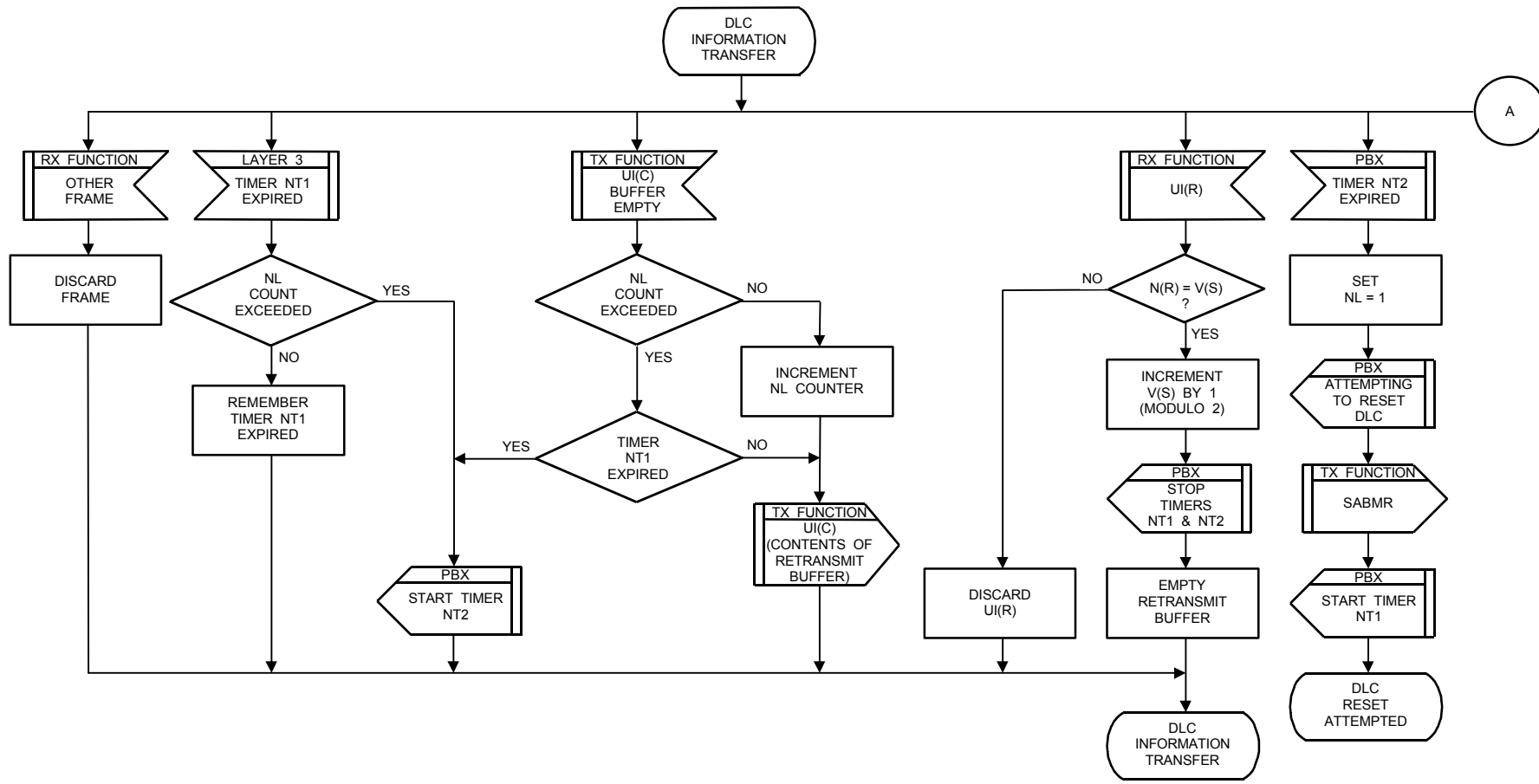

DPNSS 1 LAYER 2:
DATA LINK CONNECTION (DLC) INFORMATION TRANSFER
FIG.6 (DPNSS[188] SECTION 3) SHEET 1 OF 2

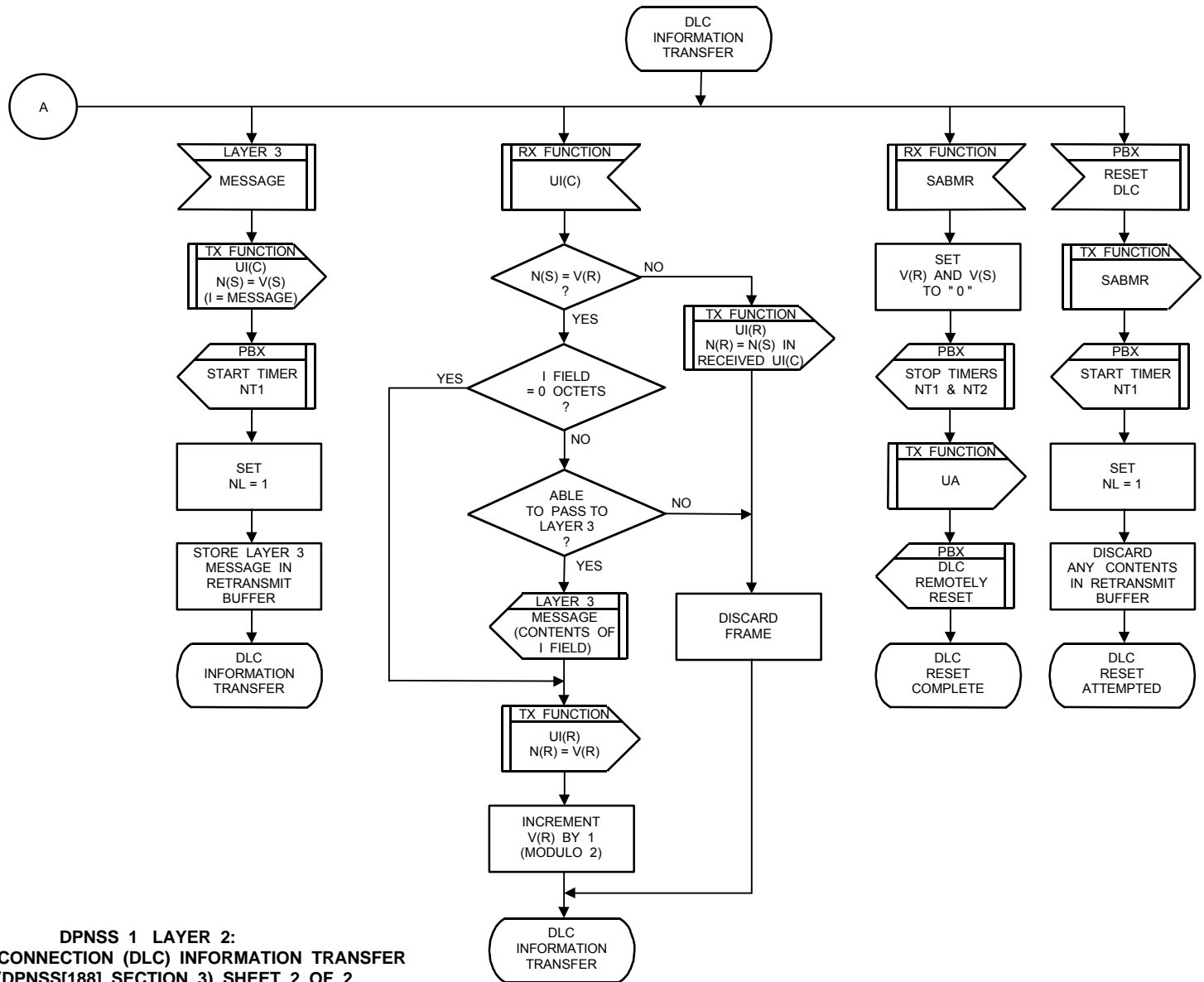

DPNSS 1 LAYER 2:
DATA LINK CONNECTION (DLC) INFORMATION TRANSFER
FIG.6 (DPNSS[188] SECTION 3) SHEET 2 OF 2

DIGITAL PRIVATE NETWORK SIGNALLING SYSTEM NO 1 (DPNSS 1)

SECTION 4 - MESSAGE TYPES AND FORMATS

CONTENTS

1	GENERAL.....	Page 2
2	TYPES AND FORMATS OF MESSAGES.....	Page 4
3	CONTENTS OF SELECTION AND INDICATION FIELDS.....	Page 19
4	SPECIFICATION OF FORMATS USING BACKUS NAUR NOTATION....	Page 23
5	COMPLIANCE.....	Page 27

ANNEX 1 CODING OF SERVICE INDICATOR CODES

ANNEX 2 CODING AND DEFINITION OF SUPPLEMENTARY INFORMATION STRINGS

ANNEX 3 CODING OF CLEARING/REJECTION CAUSES

ANNEX 4 ALPHANUMBERIC CHARACTER SET

ANNEX 5 MESSAGE TYPE CODES

ANNEX 6 MAINTENANCE ACTIONS

ANNEX 7 CODING OF USAGE IDENTIFIERS

HISTORY

Issue 1 - May 1983

Issue 2 - February 1984

Issue 3 - September 1984

Issue 4 - March 1986

Issue 5 - December 1989

Issue 6 - January 1995

Issue 7 - March 2001 - Specification renamed as DPNSS[188]
- NSIM message and new Annex 7 added
- Annex information moved to contents

REFERENCES

CCITT Recommendation V.3

1 GENERAL

1.1 The messages defined in this Section generally comprise a one octet header followed by a variable length information field containing a string of 8-bit characters, which will be coded in accordance with International Alphabet No.5 (IA5); see ANNEX 4. Certain messages may also contain binary coded octets immediately following the header (eg the SIC octets in an ISRM - see paragraph 2.1.1).

1.2 The first octet has two 4-bit fields:

i. The Message Group Identifier

This field is used to discriminate between Message Groups; the following codes have been allocated in Bits 8 to 5 of octet 1:

0000 Call Control Message Group;

0010 End-to-End Message Group;

0100 Link-by-Link Message Group;

Note: New groups may be introduced in later issues of this specification.

ii. The Message Type Identifier

This field is used to discriminate between the various messages in a given Message Group; it is contained in Bits 4 to 1 of octet 1.

For tables relating the Message Group and Type Identifiers to the messages, (mnemonics) see ANNEX 5.

1.3 A typical message is shown overleaf; it should be noted that the first octet (Group/Type Identifier) must be provided for all messages.

Within the following diagrammatic representation, bits of an octet are numbered 8 to 1, where bit 1 is the low-order bit and is transmitted first. Octets of a message are consecutively numbered starting from 1 and are transmitted octet 1 first.

A Level 3 message is transmitted within the information field of a Level 2 frame. No other information may be transmitted in that field.

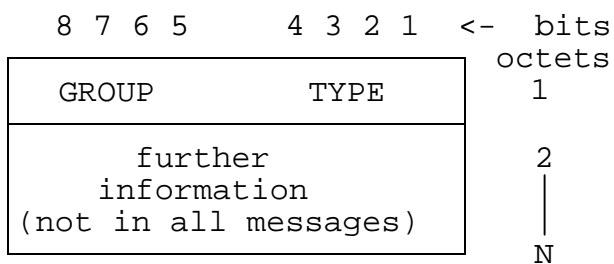

1.4 All the messages defined in this section comprise an integral number (N) of octets, where $N \leq 45$. In the following paragraphs, n is the number of octets in a SIC or Usage Identifier.

2 TYPES AND FORMATS OF MESSAGES

In the following paragraphs descriptions and formats of the messages are given in the order of their Group and Type code. The alphabetical index below may be used to aid location of particular message descriptions and formats from their mnemonics.

ALPHABETICAL INDEX TO MESSAGE DESCRIPTIONS

Mnemonic	Name	Paragraph
CCM	- Call Connected Message	2.1.5
CIM	- Clear Indication Message	2.1.8
CRM	- Clear Request Message	2.1.7
EEM(C)	- End-to-End Message (Complete)	2.2.1
EEM(I)	- End-to-End Message (Incomplete)	2.2.2
ERM(C)	- End-to-End Recall Message (Complete)	2.2.5
ERM(I)	- End-to-End Recall Message (Incomplete)	2.2.6
ISRM(C)	- Initial Service Request Message (Complete)	2.1.1
ISRM(I)	- Initial Service Request Message (Incomplete)	2.1.2
LLM(C)	- Link-by-Link Message (Complete)	2.3.1
LLM(I)	- Link-by-Link Message (Incomplete)	2.3.2
LLRM	- Link-by-Link Reject Message	2.3.3
LMM	- Link Maintenance Message	2.3.5
LMRM	- Link Maintenance Reject Message	2.3.6
NAM	- Number Acknowledge Message	2.1.9
NIM	- Network Indication Message	2.1.6
NSIM	- Non Specified Information Message	2.2.7
RM(C)	- Recall Message (Complete)	2.1.3
RM(I)	- Recall Message (Incomplete)	2.1.4
RRM	- Recall Rejection Message	2.1.10
SM	- Swap Message	2.3.4
SCIM	- Single-Channel Clear Indication Message	2.2.4
SCRM	- Single-Channel Clear Request Message	2.2.3
SSRM(C)	- Subsequent Service Request Message (Complete)	2.1.12
SSRM(I)	- Subsequent Service Request Message (Incomplete)	2.1.11

2.1 CALL CONTROL MESSAGE GROUP

2.1.1 INITIAL SERVICE REQUEST Message (COMPLETE) - ISRM (C)

The format of the ISRM(C) is as follows:

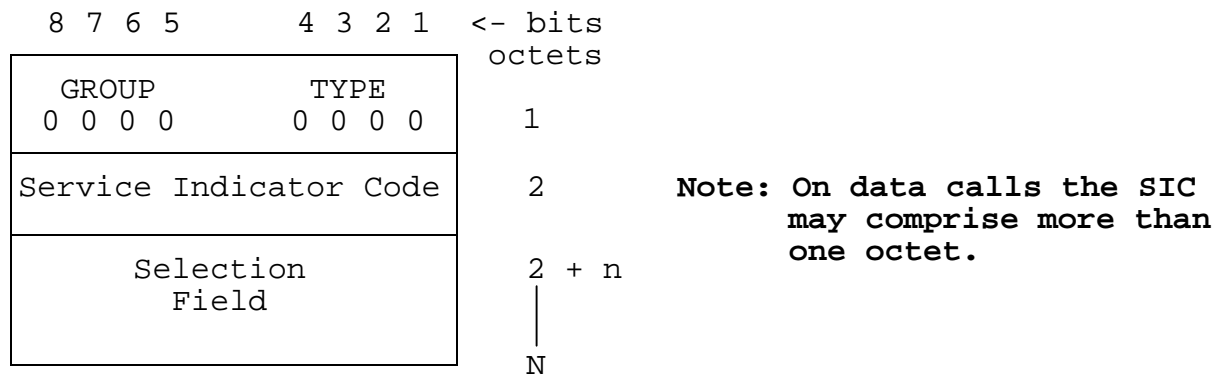

The ISRM(C) is used to establish a new call across the network. The call may be Real or Virtual. This message contains the complete request and should not be followed by any Subsequent Service Request Messages (SSRMs) - see paragraphs 2.1.11 and 2.1.12.

The Service Indicator Code (SIC) is used to indicate the type of call being made, ie Telephony or Data.

In general, no special routing for Telephony calls is required and a single SIC has been allocated. However if a special route is required this will be indicated in the Selection Field (see Bearer Service Selection, SECTION 18). In the case of certain Data calls, routing must be via a 64 kbit/s channel; additional information is also required on the specific data rate and rate-adaptation method, therefore a range of SICs has been allocated (see ANNEX 1) to prevent the interconnection of incompatible equipment.

The Selection Field contains the selection information relating to a call set-up or Supplementary Service Request, and is structured as shown in Subsection 3.

2.1.2 INITIAL SERVICE REQUEST Message (INCOMPLETE) - ISRM(I)

The format of the ISRM(I) is as follows and is structured as for the ISRM(C).

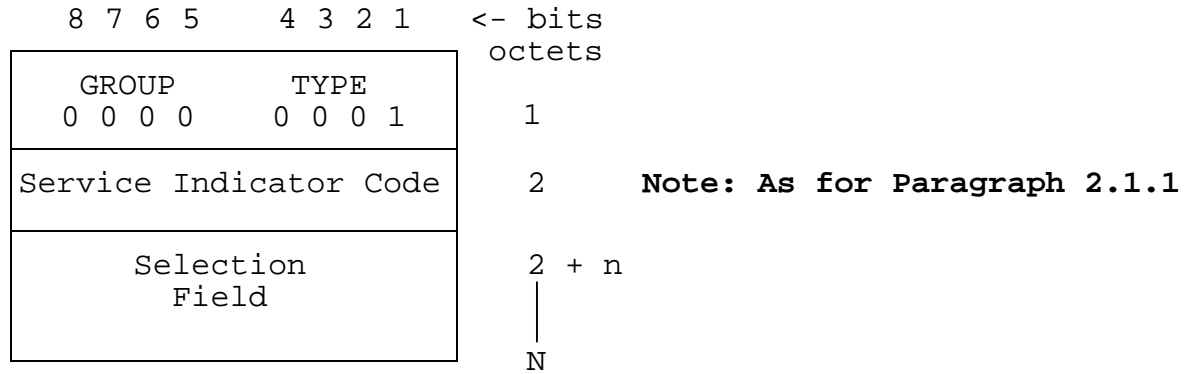

This message is used instead of an ISRM(C) under the following circumstances:

- i. Where the 45 octets of an ISRM(C) are not enough to hold the selection information and the Destination Address.
- ii. Where Destination Address digits are sent to a slower speed signalling system eg 10 pps.
- iii. Where end-of-dialling cannot be determined by the Originating PBX.

An ISRM(I) is normally followed by at least one Subsequent Service Request Message containing further selection information eg Destination Address digits (see paragraphs 2.1.11 and 2.1.12).

2.1.3 RECALL Message (COMPLETE) - RM(C)

The format of the RM(C) is as follows:

8 7 6 5	4 3 2 1	<- bits	
		octets	
GROUP 0 0 0 0	TYPE 0 0 1 0	1	
Service Indicator Code		2	Note: As for Paragraph 2.1.1
Selection Field		2 + n N	

This message is used, only after completion of the routing phase, by certain Supplementary Services to establish a second call via the same channel as an existing call. It contains the complete call request and should not be followed by any SUBSEQUENT SERVICE REQUEST Messages.

The Service Indicator Code (SIC) and Selection Field are used in the same way as in the ISRM (see paragraph 2.1.1).

2.1.4 RECALL Message (INCOMPLETE) - RM(I)

The format of the RM(I) is as follows:

8 7 6 5	4 3 2 1	<- bits	
		octets	
GROUP 0 0 0 0	TYPE 0 0 1 1	1	
Service Indicator Code		2	Note: As for Paragraph 2.1.1
Selection Field		2 + n N	

This message is used, only after completion of the routing phase, by certain Supplementary Services to establish a second call via the same channel as an existing call. It is used in place of an RM(C) under the same circumstances as an ISRM(I) is used in place of an ISRM(C). It is normally followed by at least one SSRM containing further selection information, eg Destination Address digits.

2.1.5 CALL CONNECTED Message - CCM

The format of the CCM is as follows:

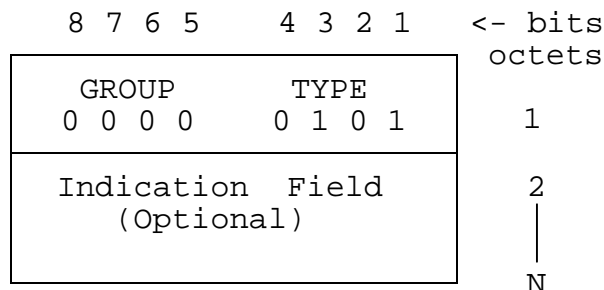

This message indicates to the Originating PBX that the call has been answered by the called terminal and that the speech or data phase can be entered.

The Indication Field contains supplementary information and is structured as shown in Subsection 3.

2.1.6 NETWORK INDICATION Message - NIM

The format of the NIM is as follows:

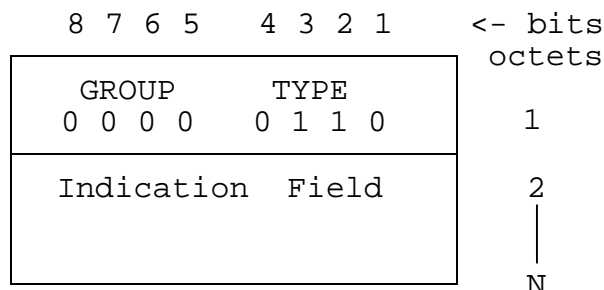

This message is used only during the routing phase of a call to notify PBXs along the route of its progress, eg Alternative Routing. The message can be used only in the backward direction and cannot be used after a NAM.

The Indication Field contains supplementary information and is structured as shown in Subsection 3.

2.1.7 CLEAR REQUEST Message - CRM

The format of the CRM is as follows:

8 7 6 5	4 3 2 1	<- bits
		octets
GROUP 0 0 0 0	TYPE 1 0 0 0	1
Clearing Cause		2
Indication Field (Optional)		3 N

This message is used to initiate the clearing sequence. Each PBX in a multi-link call releases the connection, repeats the Clear Request Message to the next link, and returns a Clear Indication Message to confirm that the channel is now free. An Indication Field can be provided for additional information that is not contained within the Clearing Cause field.

The coding of the Clearing Cause field is given in ANNEX 3.

2.1.8 CLEAR INDICATION Message - CIM

The format of the CIM is as follows:

8 7 6 5	4 3 2 1	<- bits
		octets
GROUP 0 0 0 0	TYPE 1 0 0 0	1
Clearing Cause		2
Indication Field (Optional)		3 N

This message is used to acknowledge a CRM. The coding of the Clearing Cause field is given in ANNEX 3, and normally contains the same Clearing Cause as was received in the CRM.

2.1.9 NUMBER ACKNOWLEDGE Message - NAM

The format of the NAM is as follows:

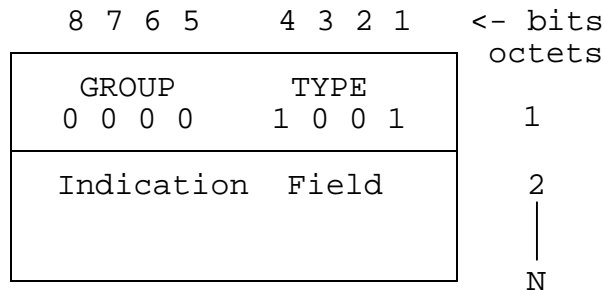

This message is sent for successful Simple Calls within DPNSS. The message is also used to indicate that all digits have been received in certain interworking situations eg with an outgoing call to a 10 pps link. The use of the NAM for non-Simple Calls (eg calls containing or encountering Supplementary Services) does not automatically imply that the required extension is free; that information may be unknown at this stage. Subsequent messages containing additional information will follow.

The Indication Field contains an IA5 character sequence. This usually includes the Called Line Category (CLC) and Called Line Identity (CLI), and may include other supplementary information.

The Indication Field is structured as shown in Subsection 3.

2.1.10 RECALL REJECTION Message - RRM

The format of the RRM is as follows:

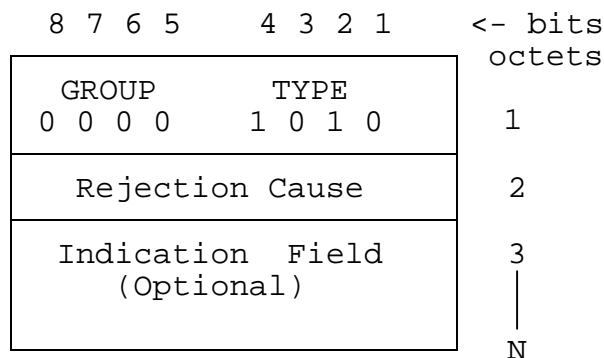

This message is used to indicate that a Recall Request has not succeeded.

An Indication Field can be provided for additional information that is not contained within the Rejection Cause field. The Rejection Cause field is coded in the same way as the Clearing Cause field (see ANNEX 3).

**2.1.11 SUBSEQUENT SERVICE REQUEST Message
 (INCOMPLETE) - SSRM(I)**

The format of the SSRM(I) is as follows:

8 7 6 5	4 3 2 1	<- bits
		octets
GROUP 0 0 0 0	TYPE 1 0 1 1	1
Selection Field		2 N

This message is used to send additional selection information (eg digits) not included in a preceding ISRM(I), ERM(I), RM(I) or SSRM(I). An indefinite number of SSRM(I)s can follow an ISRM(I), ERM(I) or RM(I); the sequence is normally completed by an SSRM(C).

The Selection Field contains the selection information relating to a call set-up or Supplementary Service Request and is structured as shown in Subsection 3.

**2.1.12 SUBSEQUENT SERVICE REQUEST Message
 (COMPLETE) - SSRM(C)**

The format of the SSRM(C) is as follows:

8 7 6 5	4 3 2 1	<- bits
		octets
GROUP 0 0 0 0	TYPE 1 1 0 0	1
Selection Field (Optional)		2 N

This message is used to send additional selection information (eg digits) not included in a preceding ISRM(I), ERM(I), RM(I) or SSRM(I) and to indicate the end of selection. No further Subsequent Service Request Messages can be sent after this message.

The sequence started by an ISRM(I), ERM(I) or RM(I) will not always be completed by an SSRM(C).

The Selection Field contains the selection information relating to a call set up or Supplementary Service Request. It may be omitted if the SSRM is indicating merely the end of selection.

2.2 END-TO-END MESSAGE GROUP

2.2.1 END-to-END Message (COMPLETE) - EEM(C)

The format of the EEM(C) is as follows:

8 7 6 5	4 3 2 1	<- bits
		octets
GROUP	TYPE	
0 0 1 0	0 0 1 0	1
Indication Field		2
		N

This message is used only after completion of the routing phase to carry end to end information between Originating, Terminating and Branching PBXs in the forward or backward direction. The message may be used both before and after answer. This message contains supplementary information and is a complete request. This message is also used to indicate the completion of an end-to-end sequence which was started with an EEM(I).

The Indication Field contains supplementary information and is structured as shown in Subsection 3.

2.2.2 END-to-END Message (INCOMPLETE) - EEM(I)

The format of the EEM(I) is as follows:

8 7 6 5	4 3 2 1	<- bits
		octets
GROUP	TYPE	
0 0 1 0	0 0 1 1	1
Indication Field		2
		N

This message is used only after completion of the routing phase to carry end-to-end information between Originating, Terminating and Branching PBXs in the forward or backward direction. The message may be used both before and after answer. It is used when the 45 octets of an EEM(C) are not enough to hold the supplementary information. The sequence started by an EEM(I) will be completed by an EEM(C) unless the call is cleared in between.

The Indication Field contains supplementary information and is structured as shown in Subsection 3.

2.2.3 SINGLE-CHANNEL CLEAR REQUEST Message - SCRM

The format of the SCRM is as follows:

8 7 6 5	4 3 2 1	<- bits
GROUP	TYPE	octets
0 0 1 0	0 1 0 0	1
Clearing Cause		2
Indication Field (Optional)		3
		N

This message is used to initiate the clearing sequence of one of the calls on a channel in dual use. The particular call of the two which is to be released is indicated by a Supplementary Information String within the Indication Field of the message. On receipt of an SCRM, a PBX releases the indicated call and returns an SCIM to confirm that the channel is now in single use. In the case of a Transit PBX, the SCRM is then repeated to the next link.

The Indication Field contains supplementary information and is structured as shown in Subsection 3.

The coding of the Clearing Cause field is given in ANNEX 3.

2.2.4 SINGLE-CHANNEL CLEAR INDICATION Message - SCIM

The format of the SCIM is as follows:

8 7 6 5	4 3 2 1	<- bits
GROUP	TYPE	octets
0 0 1 0	0 1 0 1	1
Clearing Cause		2
Indication Field (Optional)		3
		N

This message is used to acknowledge an SCRM.

The coding of the Clearing Cause field is given in ANNEX 3, and normally contains the same Clearing Cause as was received in the SCRM.

The Indication Field contains supplementary information and is structured as shown in Subsection 3.

2.2.5 END-to-END RECALL Message (COMPLETE) - ERM(C)

The format of the ERM(C) is as follows:

8 7 6 5	4 3 2 1	<- bits	
		octets	
GROUP 0 0 1 0	TYPE 0 1 1 0	1	
Service Indicator Code		2	Note: As for Paragraph 2.1.1
Selection Field		2 + n N	

This message is used, only after completion of the routing phase, by certain Supplementary Services to establish a second call, via the same channel as an existing call, as far as the existing call's End PBX. It contains the complete recall request and should not be followed by any Subsequent Service Request Messages.

The Service Indicator Code (SIC) and Selection Field are used in the same way as in the ISRM (see paragraph 2.1.1).

2.2.6 END-to-END RECALL Message (INCOMPLETE) - ERM(I)

The format of the ERM(I) is as follows:

8 7 6 5	4 3 2 1	<- bits	
		octets	
GROUP 0 0 1 0	TYPE 0 1 1 1	1	
Service Indicator Code		2	Note: As for Paragraph 2.1.1
Selection Field		2 + n N	

This message is used, only after completion of the routing phase, by certain Supplementary Services to establish a second call via the same channel as an existing call, as far as the existing call's End PBX. It is used in place of an ERM(C) under the same circumstances as an ISRM(I) is used in place of an ISRM(C). It is normally followed by at least one SSRM containing further selection information, eg Destination Address digits.

2.2.7 NON SPECIFIED INFORMATION Message - NSIM

The format of the NSIM is as follows:

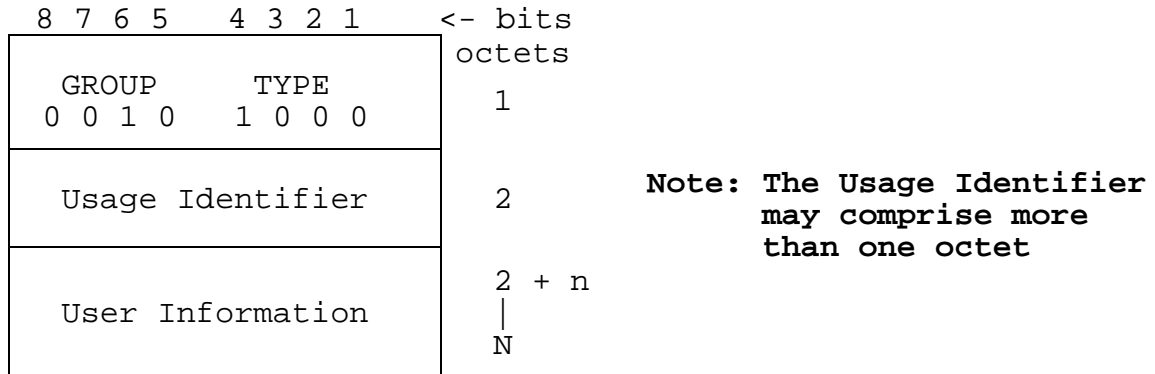

This message may be sent in the backward direction at any time in a call, and in the forward direction after completion of the routing phase of a call, to carry non-DPNSS 1 defined information between End PBXs. Although the format of the User Information is not defined within DPNSS 1, the type of information conveyed is dependent on the coding of the Usage Identifier, as described in section 49.

Note: The octets comprising user information are not constrained to be IA5 characters and consequently all eight bits of each octet are available for use.

2.3 LINK-BY-LINK MESSAGE GROUP

2.3.1 LINK-by-LINK Message (COMPLETE) - LLM(C)

The format of the LLM(C) is as follows:

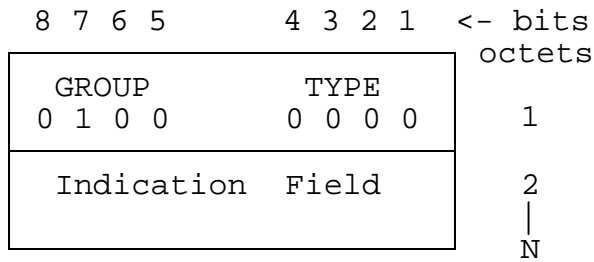

This message is used only after completion of the routing phase to carry information between adjacent PBXs. It is also used to indicate the completion of a link-by-link sequence which was started with an LLM(I).

The Indication Field contains supplementary information and is structured as shown in Subsection 3.

2.3.2 LINK-by-LINK Message (INCOMPLETE) - LLM(I)

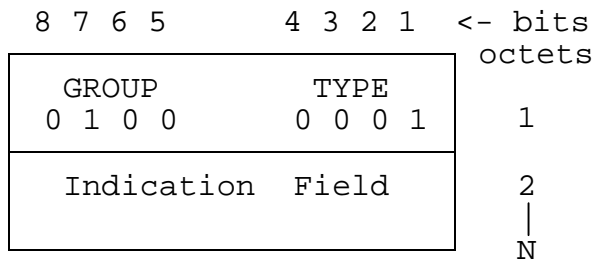

This message is used only after the completion of the routing phase to carry information between adjacent PBXs. It is used when the 45 octets of an LLM(C) are not enough to hold the necessary information. The sequence started by an LLM(I) will be completed by an LLM(C) unless the call is cleared in between.

The Indication Field contains supplementary information and is structured as shown in Subsection 3.

2.3.3 LINK-by-LINK REJECT Message - LLRM

The format of the LLRM is as follows.

8 7 6 5	4 3 2 1	<- bits	
		octets	
GROUP 0 1 0 0	TYPE 0 0 1 0	1	
Rejection Cause		2	
Indication Field (Optional)		3 N	

This message is used to reject an unrecognised or invalid message in the Link-by-Link message group (0100). The Rejection Cause field is coded in the same way as the Clearing Cause field. (See ANNEX 3)

2.3.4 SWAP Message - SM

The format of the SM is as follows:

8 7 6 5	4 3 2 1	<- bits	
		octets	
GROUP 0 1 0 0	TYPE 0 1 0 0	1	
Service Indicator Code		2	Note: As for Paragraph 2.1.1
Indication Field		2 + n N	

This message is used during a call to request a change from the current service mode to a new mode as shown by the Service Indicator Code. The Service Indicator Code is coded in accordance with ANNEX 1.

The message is also used to acknowledge a SWAP.

The Indication Field contains supplementary information and is structured as shown in Subsection 3.

2.3.5 LINK MAINTENANCE Message - LMM

The format of the LMM is as follows:

8 7 6 5	4 3 2 1	<- bits
		octets
GROUP	TYPE	
0 1 0 0	0 1 0 1	1
Maintenance Action		2
Indication Field		3
		N

This message is used to request, or respond to a request for, maintenance actions to be performed. The Maintenance Action field identifies the action required or the response being made. The Maintenance Action field is coded as shown in ANNEX 6.

The message may be sent independently of the state of any call in progress on the channel.

The Indication Field contains supplementary information and is structured as shown in Subsection 3.

2.3.6 LINK MAINTENANCE REJECT Message - LMRM

The format of the LMRM is as follows:

8 7 6 5	4 3 2 1	<- bits
		octets
GROUP	TYPE	
0 1 0 0	0 1 1 0	1
Clearing Cause		2
Indication Field		3
		N

This message is used to respond to a request for maintenance actions to be performed, when the request has been rejected.

The coding of the Clearing Cause field is given in ANNEX 3.

The Indication Field contains supplementary information and is structured as shown in Subsection 3.

3 CONTENTS OF SELECTION AND INDICATION FIELDS

Information is carried in Selection and Indication Fields in the form of IA5 characters which, with the exception of the Destination Address, are structured into Supplementary Information Strings.

This paragraph outlines the contents of the Fields; Subsection 4 gives the format using Backus-Naur notation.

3.1 Supplementary Information Strings

A Supplementary Information String comprises a Supplementary Information Identifier which may be followed by one or more Parameters. A Supplementary Information String starts with the IA5 character * and ends with the IA5 character #.

When the Supplementary Information String includes Parameters these are separated from the identifier and each other by a *.

```
eg  * Supplementary Information Identifier code #  
or  * Supplementary Information Identifier code * Parameter #  
or  * Supplementary Information Identifier code * Parameter  
    * Parameter #
```

A Supplementary Information String shall be wholly contained within one Selection or Indication Field (ie it shall not be split between messages).

3.2 Supplementary Information String Identifier

The identifier comprises one or more IA5 numerals 0-9 which may be followed by a single IA5 alpha-character suffix in the range A-Z.

The numerals of the identifier indicate the main function of the Supplementary Information String, eg "39F" indicates "Diverting on No Reply". "F" is the suffix.

As shown in TABLE 1 the suffix letter of the identifier indicates whether the Supplementary Information String is mandatory, optional or informative with respect to the functions being provided by the PBX receiving it. Three PBX functions are defined: Transit, Branching and End (see SECTION 5).

The suffix is examined only when the numerical part of the identifier is unrecognised (as defined in SECTION 5 Paragraph 4.3.1). Then by comparing the suffix with the operative PBX functions the PBX is able to allow certain messages to be handled even though some of the message contents are not understood.

This enables the signalling system to evolve, and reduces the need to modify all PBXs in a network when the new services are added.

TABLE 1

ALLOCATION OF SUPPLEMENTARY INFORMATION STRING IDENTIFIER SUFFIX LETTERS									
IDENTIFIER SUFFIX LETTER	PBX FUNCTIONS								
	TRANSIT Function			BRANCHING Function			END Function		
	I	O	M	I	O	M	I	O	M
NONE	/			/			/		
A	/			/			/	/	
B	/			/					/
C	/				/		/		
D	/				/			/	
E	/				/				/
F	/					/	/		
G	/					/	/	/	
H	/					/		/	/
I		/		/			/		
J		/		/				/	
K		/		/					/
L		/			/		/		
M		/			/			/	
N		/			/				/
O		/				/	/		
P		/				/	/	/	
Q		/				/	/		/
R			/	/			/		
S			/	/				/	
T			/	/					/
U			/		/		/		
V			/		/			/	
W			/		/				/
X			/			/	/		
Y			/			/		/	
Z			/			/			/

Key : M = Mandatory O = Optional I = Informative

3.3 Supplementary Information String Parameters

The Parameter(s) of a Supplementary Information String are of variable length and comprise a number of IA5 characters (excluding * and #).

Where a numeric value of a Parameter is encoded as a sequence of IA5 numeric characters, the characters shall be sent most significant first.

The Supplementary Information Identifiers and the Parameter coding shall be in accordance with ANNEX 2. Identifier codes and Parameters other than those shown in ANNEX 2 shall not be sent.

3.4 Order of Supplementary Information Strings

Supplementary Information Strings can be assembled in any order.

3.5 Destination Address

The Destination Address comprises one or more IA5 numerals 0 to 9, has no identifier code and is not prefixed by a * or terminated by a #. The digits are always the last characters in the Selection Block. The first Destination Address digit immediately follows the # of the last Supplementary Information String.

The Destination Address is that digit sequence which, when sent over the DPNSS 1 Network Boundary, will cause a call to be routed to the required destination.

The DPNSS 1 Network Boundary is a conceptual interface which divides an exchange into a part which is connected to DPNSS 1 trunks, and a part which is connected to extensions and non-DPNSS 1 trunks.

NOTE: A call from one extension may need one or more digits to route the call across the Network Boundary; this digit sequence does not form part of the Destination Address.

DPNSS 1 itself does not impose a limit on the length of a Destination Address. Practical constraints on the storage for numbers in PBXs mean that there must be a limit to the length of the Destination Address within each network. However, the numbering schemes of individual networks will place minimum requirements on the address lengths required to be handled. These schemes are likely to have differing requirements for addresses which represent destinations which are considered to be part of the DPNSS 1 network (ie extensions, operators and PBXs) and addresses which cause routing to destinations outside the DPNSS 1 network via a Gateway PBX (ie those accessed via other signalling systems).

NOTE: THE MAXIMUM ADDRESS LENGTHS WHICH A PBX CAN HANDLE ARE A DESIGN CONSIDERATION AND IT IS THEREFORE NECESSARY TO ENSURE WHEN CONSTRUCTING A NETWORK THAT THE ADDRESSING CAPABILITIES OF THE PBXs CONNECTED TOGETHER ARE COMPATIBLE WITH THE NUMBERING SCHEME OF THE NETWORK.

When a Destination Address is passed on by a Transit PBX the significance of the Destination Address, in terms of the destination it identifies, shall not be altered.

Thus, in the simplest case, a numbering scheme for a network will be such that:

- each PBX in a network, when acting as an Originating PBX, generates a Destination Address with network-wide significance insofar as that Destination Address unambiguously identifies the required destination at all PBXs within the network;
- each PBX in the network, when acting as a Transit PBX, passes on a Destination Address unchanged.

It may, however, be possible in some network configurations for a Transit PBX to translate a Destination Address which has a network-wide significance into one which has a more local significance.

It may also be possible for an Originating PBX to generate a Destination Address with only local significance.

In the latter two cases, care must be taken to ensure that a call which is being routed with a Destination Address which has only local significance, is not subsequently routed into a part of the network where the Destination Address might be ambiguous, without an appropriate translation being applied.

A PBX claiming to support DPNSS 1 shall, as a minimum, have the capability to generate Destination Addresses with network-wide significance when acting as an Originating PBX, and the capability to pass on Destination Addresses unchanged when acting as a Transit PBX. The capability to support other forms of Destination Address handling, when acting either as an Originating or as a Transit PBX, is optional and shall only be used in a network with the agreement of all involved parties.

Note: The Parameters to Supplementary Information Strings which are defined to represent Destination Addresses, for example, the A Party Address as described in ANNEX 2, shall always be passed on unchanged by Transit PBXs.

4 SPECIFICATION OF FORMATS USING BACKUS-NAUR NOTATION

The following description uses a notation based on Backus-Naur form to define the Selection and Indication Block coding scheme.

In this notation:

- A sequence of characters enclosed in the brackets < > is description of an entity eg <SELECTION BLOCK>
- Braces { } are used to enclose a repeated item. The item may be repeated zero or more times.
- Square brackets [] indicate that the enclosed item is optional.
- The character :: = means "is defined as".
- The character | means "or".
- Any other character not enclosed in the brackets < > represents itself.

4.1 Selection Block

One or more Selection Fields are used to transport the Selection Block.

The Selection Block contains the selection information relating to a call set-up or Supplementary Service request. It is made up from one of the following:

- The Selection Field from an ISRM(C);
- The concatenated Selection Fields from an ISRM(I) and any related SSRMs;
- The Selection Field from an ERM(C);
- The Selection Field from an RM(C);
- The concatenated Selection Fields from an ERM(I) and any related SSRMs;
- The concatenated Selection Fields from an RM(I) and any related SSRMs.

No PBX shall impose an upper limit of less than 135 octets on the size of the Selection Block.

The Selection Block is constructed from two parts: the Supplementary Information and the Destination Address. The make-up of these is as follows:

<SELECTION BLOCK> :: =
<SUPPLEMENTARY INFORMATION>[<DESTINATION ADDRESS>]

<SUPPLEMENTARY INFORMATION> :: =
<SUPPLEMENTARY INFORMATION STRING>{<SUPPLEMENTARY INFORMATION STRING>}

<DESTINATION ADDRESS> :: = <NUMERIC CHARACTER SEQUENCE>

<SUPPLEMENTARY INFORMATION STRING> :: =
<*><SUPPLEMENTARY INFORMATION IDENTIFIER>{<*><PARAMETER>}<#>

<SUPPLEMENTARY INFORMATION IDENTIFIER> :: =
<NUMERIC CHARACTER SEQUENCE> [<CAPITAL ALPHA CHARACTER>]

<PARAMETER> :: = <RESTRICTED IA5 CHARACTER SEQUENCE>

<RESTRICTED IA5 CHARACTER SEQUENCE> :: =
<RESTRICTED IA5 CHARACTER>{<RESTRICTED IA5 CHARACTER>}

<NUMERIC CHARACTER SEQUENCE> :: =
<NUMERIC CHARACTER>{<NUMERIC CHARACTER>}

<RESTRICTED IA5 CHARACTER> :: =
<ALPHA CHARACTER >|< NUMERIC CHARACTER>|<RESTRICTED IA5 GRAPHIC CHARACTER>|<IA5 CONTROL CHARACTER>

<NUMERIC CHARACTER> :: = 0|1|2|3|4|5|6|7|8|9

<ALPHA CHARACTER> :: = <CAPITAL ALPHA CHARACTER>|<LOWER CASE ALPHA CHARACTER>

<LOWER CASE ALPHA CHARACTER> :: =
a|b|c|d|e|f|g|h|i|j|k|l|m|n|o|p|q|r|s|t|u|v|w|x|y|z

<CAPITAL ALPHA CHARACTER> :: =
A|B|C|D|E|F|G|H|I|J|K|L|M|N|O|P|Q|R|S|T|U|V|W|X|Y|Z

<RESTRICTED IA5 GRAPHIC CHARACTER> :: =
<SP>|!|"|£|¥|&|'|(|)|+|,|-|.|/|:|;|<|=|>|?|[|\|]|^|_|`|{|@|<VERTICAL BAR>|} |~|

<IA5 CONTROL CHARACTER> :: =
TC1|TC2|TC3|TC4|TC5|TC6|BEL|FE0|FE1|FE2|FE3|FE4|FE5|SO|SI|TC7|DC1|DC2|DC3|DC4|TC8|TC9|TC10|CAN|EM|SUB|ESC|IS4|IS3|IS2|IS1

NOTE: numeric, alpha, graphic and control characters are encoded using IA5 (see ANNEX 4).

<SP> :: = <IA5 Character 2/0>
<#> :: = <IA5 Character 2/3>
<*> :: = <IA5 character 2/10>
<VERTICAL BAR> :: = <IA5 Character 7/12>
** :: = <IA5 Character 7/15>**

4.2 Indication Block

One or more Indication Fields are used to transport the Indication Block.

It is made up from one of the following:

- The Indication Field from a
 - Number Acknowledgement Message (NAM)
 - Network Indication Message (NIM)
 - Call Connected Message (CCM)
 - Clear Request Message (CRM)
 - Clear Indication Message (CIM)
 - End-to-End Message (Complete) EEM(C)
 - Recall Reject Message (RRM)
 - Link-by-Link Message (Complete) LLM(C)
 - Link-by-Link Reject Message (LLRM)
 - Swap Message (SM)
 - Single-Channel Clear Request Message (SCRM)
 - Single-Channel Clear Indication Message (SCIM)
- The concatenated Indication Fields from a number of EEM(I)s and the associated EEM(C);
- The concatenated Indication Fields from a number of LLM(I)s and the associated LLM(C).

No PBX shall impose an upper limit of less than 135 octets on the size of the Indication Block.

An Indication Block contains Supplementary Information Strings formatted as follows:

<INDICATION BLOCK> ::= <SUPPLEMENTARY INFORMATION>

<SUPPLEMENTARY INFORMATION> ::= =
<SUPPLEMENTARY INFORMATION STRING>{<SUPPLEMENTARY INFORMATION STRING>}

<SUPPLEMENTARY INFORMATION STRING> ::= =
<*><SUPPLEMENTARY INFORMATION IDENTIFIER>{<*><PARAMETER>}<#>

<SUPPLEMENTARY INFORMATION IDENTIFIER> ::= =
<NUMERIC CHARACTER SEQUENCE>[<CAPITAL ALPHA CHARACTER>]

<NUMERIC CHARACTER SEQUENCE> ::= =
<NUMERIC CHARACTER>{<NUMERIC CHARACTER>}

<PARAMETER> :: = <RESTRICTED IA5 CHARACTER SEQUENCE>

**<RESTRICTED IA5 CHARACTER SEQUENCE> :: =
<RESTRICTED IA5 CHARACTER>{<RESTRICTED IA5 CHARACTER>}**

**<RESTRICTED IA5 CHARACTER> :: =
<NUMERIC CHARACTER>|<ALPHA CHARACTER>|<RESTRICTED IA5 GRAPHIC
CHARACTER>|<IA5 CONTROL CHARACTER>**

<NUMERIC CHARACTER> :: = 0|1|2|3|4|5|6|7|8|9

**<ALPHA CHARACTER> :: = <CAPITAL ALPHA CHARACTER>|<LOWER CASE ALPHA
CHARACTER>**

**<LOWER CASE ALPHA CHARACTER> :: =
a|b|c|d|e|f|g|h|i|j|k|l|m|n|o|p|q|r|s|t|u|v|w|x|y|z|**

**<CAPITAL ALPHA CHARACTER> :: =
A|B|C|D|E|F|G|H|I|J|K|L|M|N|O|P|Q|R|S|T|U|V|W|X|Y|Z|**

**<RESTRICTED IA5 GRAPHIC CHARACTER> :: =
<SP>|!|"|£|¥|&|'|(|)|+|,|-|.|/|:|;|<|=|>|?|[|\]|^|_|`|{|@|
<VERTICAL BAR>|}~|**

**<IA5 CONTROL CHARACTER> :: =
TC1|TC2|TC3|TC4|TC5|TC6|BEL|FE0|FE1|FE2|FE3|FE4|FE5|SO|SI|TC7|
DC1|DC2|DC3|DC4|TC8|TC9|TC10|CAN|EM|SUB|ESC|IS4|IS3|IS2|IS1**

**NOTE: numeric, alpha graphic and control characters are encoded
using IA5 (see ANNEX 4).**

<SP> :: = <IA5 character 2/0>

<#> :: = <IA5 character 2/3>

<*> :: = <IA5 character 2/10>

<VERTICAL BAR> :: = <IA5 character 7/12>

** :: = <IA5 character 7/15>**

5 COMPLIANCE

This Section gives the coding and format for all of the messages and message contents currently used in DPNSS 1.

The ability to recognise all of the messages specified in this Section, except LMM, LMRM, NSIM, SCRM, SCIM, RRM and ERM, is mandatory on all DPNSS 1 PBXs.

Recognition of the LMM and the LMRM is mandatory if the PBX supports the Traffic-Channel Maintenance Supplementary Service.

Recognition of the NSIM is mandatory if the PBX supports the Non Specified Information Message Supplementary Service.

Recognition of the SCRM and the SCIM is mandatory if the PBX supports Single Channel Working for a service where the original call is retained after the second call is established, eg Three Party Call.

Recognition of the RRM and ERM is mandatory if the PBX supports Single Channel Working.

NOTE: It is necessary for a PBX to SEND an RRM on receipt of an RM when Single Channel Working is NOT supported.

The ability to send and recognise Supplementary Information Strings is necessary only for those Strings that are defined in the DPNSS 1 Services and Supplementary Services that are supported by the PBX.

The ability to act correctly upon the Identifier Suffix of unrecognised Supplementary Information Strings is mandatory.

Any message or Supplementary Information String that is sent shall comply with the requirements of this Section.

The ability to send and recognise the Clearing Causes specified in ANNEX 3 is mandatory.

The ability to send and recognise Maintenance Actions specified in ANNEX 6 is necessary only if the Traffic-Channel Maintenance Supplementary Service is supported.

DIGITAL PRIVATE NETWORK SIGNALLING SYSTEM NO 1 (DPNSS 1)

SECTION 4

ANNEX 1 : CODING OF SERVICE INDICATOR CODES

CONTENTS

1	GENERAL	Page 2
2	OCTET 1	Page 2
3	OCTET 2	Page 6

HISTORY

Issue 1 - May 1983
Issue 2 - February 1984
Issue 3 - September 1984
Issue 4 - March 1986
Issue 5 - December 1989
Issue 6 - January 1995

Issue 7 - March 2001 - Specification renamed as DPNSS[188]
- Further notes for Octet 2 (Data type) added

1 GENERAL

The Service Indicator Code (SIC) indicates the type of call being requested (e.g., Speech or Data) and is used by the recipient PBX to select an outgoing path. The path selected must be capable of supporting the type of call being requested (e.g., if a Data Call at a bit rate of 64 kbit/s is requested, the call must not be routed via an analogue path).

BIT	8	7	6	5	4	3	2	1
OCTET 1	ext	Routing Information						
OCTET 2	ext	Synch/Asynchronous Information						

FIGURE 1: STRUCTURE DIAGRAM

2 OCTET 1

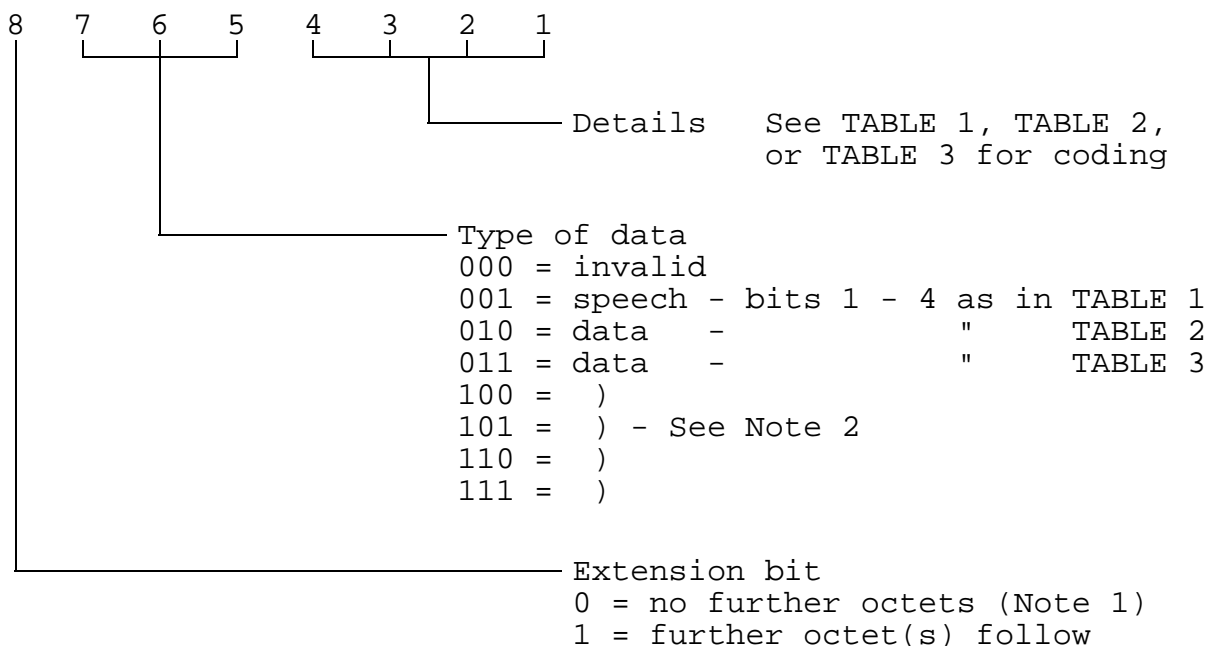

Note 1: The extension bit is set to 0 only for DPNSS 1 Speech calls (SECTION 6) or when interworking with DASS 2. For interworking, see DPNSS[189].

Extension bit set to 1 is invalid for type 001 (bits 7, 6 and 5).

Note 2: Codes 100 - 111 are used when interworking with DASS 2. If a PBX receives one of these codes it shall treat the call as if code 010 had been received and repeat the SIC unchanged.

Similarly, a PBX may send one of these codes but a recipient PBX may treat the call only as if code 010 had been received.

TABLE 1 : Type of Data (001) : Details for Speech	
0 0 0 0	= 64 kbit/s PCM G.711 A-Law or analogue
0 0 0 1	= 32 kbit/s ADPCM G.721 (Note 3)
0 0 1 0	= 64 kbit/s PCM G.711 μ -Law or analogue
0 0 1 1	= Invalid
0 1 0 0	= "
0 1 0 1	= "
0 1 1 0	= "
0 1 1 1	= "
1 0 0 0	= "
1 0 0 1	= "
1 0 1 0	= "
1 0 1 1	= "
1 1 0 0	= "
1 1 0 1	= "
1 1 1 0	= "
1 1 1 1	= "

Note 3: G.721 as shown in the CCITT RED BOOK RECOMMENDATIONS 1984.

TABLE 2 : Type of Data (010) : Data Rates

0 0 0 0	=	64000 bit/s
0 0 0 1	=	56000 bit/s
0 0 1 0	=	48000 bit/s
0 0 1 1	=	32000 bit/s
0 1 0 0	=	19200 bit/s
0 1 0 1	=	16000 bit/s
0 1 1 0	=	14400 bit/s
0 1 1 1	=	12000 bit/s
1 0 0 0	=	9600 bit/s
1 0 0 1	=	8000 bit/s
1 0 1 0	=	7200 bit/s
1 0 1 1	=	4800 bit/s
1 1 0 0	=	3600 bit/s
1 1 0 1	=	2400 bit/s
1 1 1 0	=	1200 bit/s
1 1 1 1	=	600 bit/s

TABLE 3 : Type of Data (011) : Data Rates	
0 0 0 0	= 300 bit/s
0 0 0 1	= 200 bit/s
0 0 1 0	= 150 bit/s
0 0 1 1	= 134.5 bit/s
0 1 0 0	= 110 bit/s
0 1 0 1	= 100 bit/s
0 1 1 0	= 75 bit/s
0 1 1 1	= 50 bit/s
1 0 0 0	= 75/1200 bit/s (Note 4)
1 0 0 1	= 1200/75 bit/s (Note 4)
1 0 1 0	= invalid
1 0 1 1	= "
1 1 0 0	= "
1 1 0 1	= "
1 1 1 0	= "
1 1 1 1	= "

Note 4: 75/1200 indicates a rate of 75 bit/s in the direction calling to called, and 1200/75 indicates a rate of 1200 bit/s in the direction calling to called.

3 OCTET 2

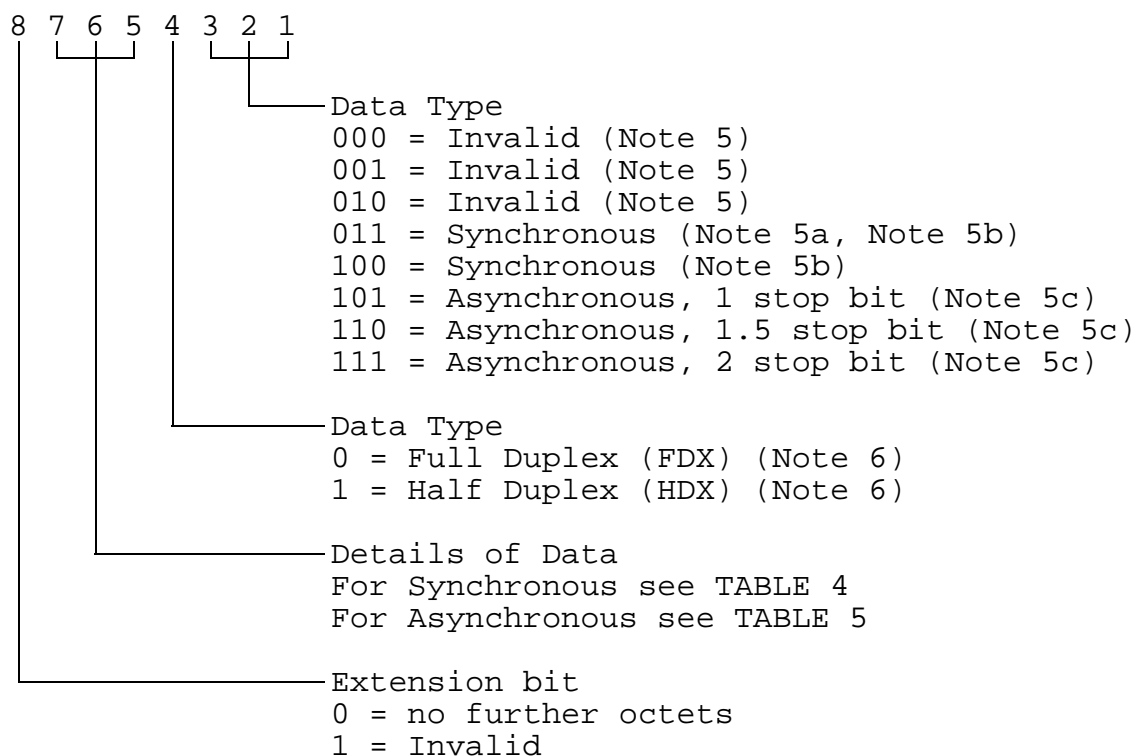

Note 5: Codes 000, 001 and 010 may be used on the Public Network for an asynchronous data rate adaptation not complying with ESRA ("ECMA Standard Rate Adaptation").

Note 5a: It is recommended that this value is not used if interworking with DASS 2 might be encountered elsewhere in the network.

Note 5b: If a data rate other than 64 kbit/s is specified in octet 1 of this SIC, then V.110/X.30 rate adaptation is assumed.

Note 5c: Codes 101, 110 and 111 imply use of ESRA.

Note 6: The terms Full Duplex and Half Duplex are as used in CCITT Recommendations X.30 and V.110.

TABLE 4 : Details of Data For Synchronous

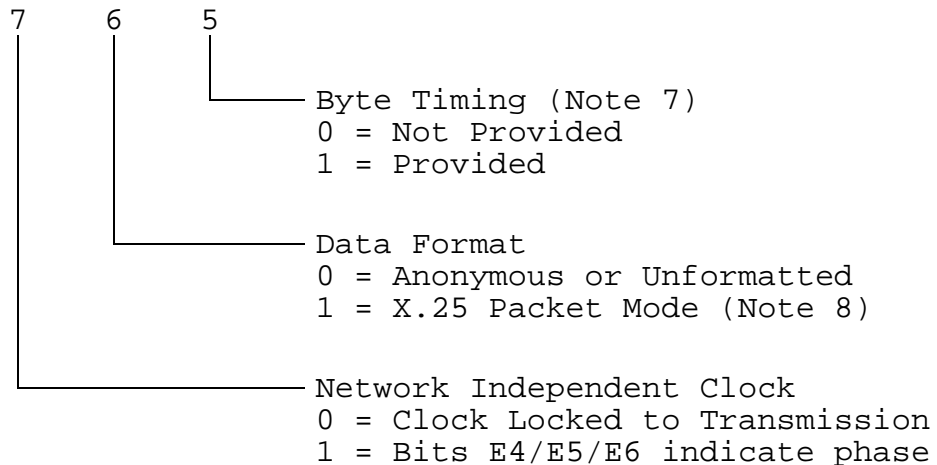

Note 7: This bit is used to indicate whether the originating end is byte-aligned to the X.30 frame (typically a character-oriented device): if 1, the originating end is byte-timed and requires to communicate to a byte-timed device; if 0, the originating end is not byte-timed (this will apply for V-series interfaces, X.21 bis interfaces, and X.21 interfaces that do not have the byte timing implemented).

If byte-timing is provided, the E7 bit in the X.30 frame is used for multiframe synchronisation at 600 bit/s and 1200 bit/s; if byte timing is not provided, the multiframes need not start on true character boundaries.

Note 8: X.25 Packet Mode signifies that data packets plus flags are present in the data bits of the X.30 frames.

TABLE 5 : Details of Data For Asynchronous

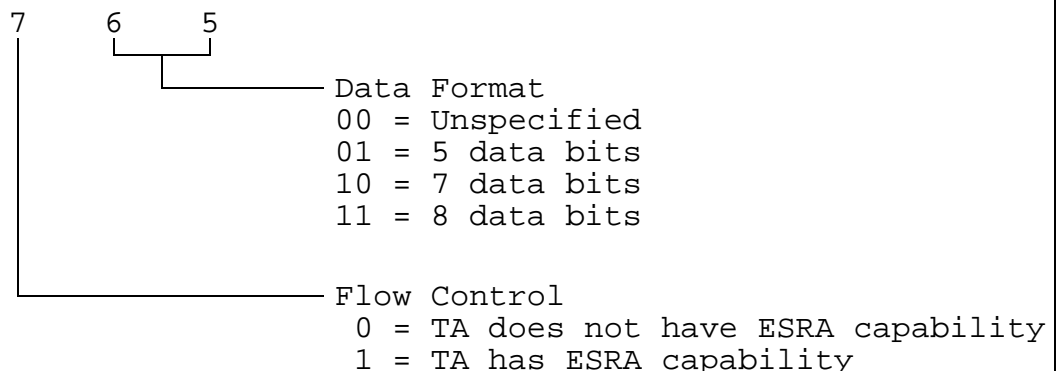

DIGITAL PRIVATE NETWORK SIGNALLING SYSTEM NO 1 (DPNSS 1)

SECTION 4

**ANNEX 2 : CODING AND DEFINITION OF SUPPLEMENTARY INFORMATION
STRINGS**

CONTENTS

1	GENERAL	Page 3
2	CODING OF SUPPLEMENTARY INFORMATION STRING IDENTIFIERS	Page 4
3	CODING OF SUPPLEMENTARY INFORMATION STRING PARAMETERS	Page 21
4	EXPLANATION OF STRING IDENTIFIERS	Page 52
5	SUPPLEMENTARY INFORMATION STRING PARAMETERS: BINARY OCTET ENCODING DETAILS	Page 86

HISTORY

- Issue 1 - May 1983
- Issue 2 - February 1984
- Issue 3 - September 1984
- Issue 4 - March 1986
- Issue 5 - December 1989
- Issue 5.1 - December 1993
- Issue 6 - January 1995

- Issue 7 - March 2001
 - Specification renamed as DPNSS[188]
 - String 110B:ROP-R Second Parameter (Call Identity Length) added
 - String 111H:ROP-CSU Parameter (Call Identity Length) added
 - String 113:DND Second Parameter (SOD Qualifier) added
 - String 245: CBM-CSU added
 - String 246A: INT-A added
 - String 248: DVL added
 - String 249: ROP-INV added
 - String 250A: ROP-INVA added
 - String 251: PCLG-P added
 - String 252: PCLG-D added
 - String 253: PCON-P added
 - String 254: PCON-D added
 - Restriction Indicator Parameter added
 - Value 6 and descriptive text added to Service Marking Parameter
 - Description of ISDN Number Attributes Parameter modified
 - Description of ISDN Number Digits Parameter modified
 - Appendix 1 incorporated as Subsection 5

1 GENERAL

This Annex gives details of the Supplementary Information String Identifiers and Parameters used in DPNSS 1 and is complete at the time of issue.

New Strings and Parameters are continually being added to DPNSS 1, however, for the following reasons:

- support of new Supplementary Services;
- support of enhanced Supplementary Services;
- additions to Service Independent Strings (SECTION 16);
- support of interworking between DPNSS 1 and other signalling systems.

This Annex is intended to record the master list of Supplementary Information Strings for all DPNSS 1 applications and will be updated periodically as the specifications are reissued. Reference should be made, however, to DPNSS[188], DPNSS[189] and DPNSS[189-I] to ensure that the latest information is taken into account.

1.1 Use of Strings

In general, Supplementary Information Strings are associated with the Services and Supplementary Services defined in SECTION 6 onwards.

Some Supplementary Information Strings, however, are not associated with a particular Supplementary Service Section, and their "First-Use Section" in the list of Identifiers is shown as SECTION 16. The use of these Strings is described in SECTION 16 of DPNSS[188] and SECTION 16 of DPNSS[189] where they are termed "Service Independent Strings".

NOTE: In Subsections 2 and 4 of this Annex the "First-Use Section" refers to DPNSS[188] unless indicated otherwise (eg 6/189 refers to a first use in SECTION 6 of DPNSS[189]).

1.2 Use of Parameters

If a Supplementary Information String has a Parameter, then the use of the Parameter is mandatory unless otherwise stated.

If more than one Parameter is indicated for a Supplementary Information String, then the Parameters must be sent in the order specified. If a Parameter is optional it will be sent last. Where more than one Parameter is optional then, in order to send the second optional Parameter, it is mandatory to send the first. The rule is extended where more than two Parameters are optional.

2 CODING OF SUPPLEMENTARY INFORMATION STRING IDENTIFIERS

ID CODE	MNEMONIC	SUPPLEMENTARY INFORMATION STRING NAME	PARAMETER	FIRST USE SECTION
1	CLC-ORD	CALLING/CALLED LINE CATEGORY - ORDINARY	SERVICE MARKING	6
2	CLC-DEC	CALLING/CALLED LINE CATEGORY - DECADIC	STATUS	6/189
3 NOTE 1	CLC-ISDN	CALLING/CALLED LINE CATEGORY - PUBLIC ISDN	(1) STATUS (2) ISDN TYPE	NOTE 1
4	CLC-PSTN	CALLING/CALLED LINE CATEGORY - PSTN	STATUS	6/189
5	CLC-MF5	CALLING/CALLED LINE CATEGORY - SSMF5	STATUS	6/189
6	CLC-OP	CALLING/CALLED LINE CATEGORY - OPERATOR	NONE	20
7	CLC-NET	CALLING/CALLED LINE CATEGORY - NETWORK	NONE	9
8 NOTE 2				
9				
10B	CBWF-R	CALL BACK WHEN FREE -REQUEST	NONE	9

NOTE 1: In DPNSS[189] and earlier issues of DPNSS[188], IDENTIFIER CODE No 3 was allocated to CLC-DASS2. The scope of this CLC has since been expanded to cover access to the public ISDN in general (DPNSS[189-I]) and the CLC has consequently been renamed as CLC-ISDN. The Status Parameter has also been expanded to allow the additional optional Parameter "ISDN Type" to be used to indicate the type of public ISDN interface encountered (see Subsection 3 of this Annex).

NOTE 2: In DPNSS[189], DPNSS[189-I] and earlier issues of DPNSS[188], IDENTIFIER CODE No 8 was allocated to CLC-CONF (Calling Line Category - Conference). No Supplementary Service has ever been written incorporating this String; to avoid confusion this String has been withdrawn and IDENTIFIER CODE No 8 is now undefined.

2 CODING OF SUPPLEMENTARY INFORMATION STRING IDENTIFIERS

ID CODE	MNEMONIC	SUPPLEMENTARY INFORMATION STRING NAME	PARAMETER	FIRST USE SECTION
11B	CBWF-FN	CALL BACK WHEN FREE -FREE NOTIFICATION	NONE	9
12B	CBWF-CSUI	CALL BACK WHEN FREE -CALL SET-UP(IMMEDIATE)	NONE	9
13B	CBWF-C	CALL BACK WHEN FREE -CANCEL	NONE	9
14B	RO	RING OUT	NONE	9
15B	CBC	CALL BACK COMPLETE	NONE	9
16B	CBWF-CSUD	CALL BACK WHEN FREE -CALL SET-UP(DELAYED)	NONE	9
17B	CBWNU-R	CALL BACK WHEN NEXT USED- REQUEST	NONE	31
18	COS	CLASS OF SERVICE	(1)ROUTE RESTRICTION CLASS (2)CALL BARRING GROUP (3)FACILITY LIST CODE	16
19	LA	LOOP AVOIDANCE	(1)NUMBER OF FURTHER TRANSITS (2)NUMBER OF FURTHER ALTERNATIVE ROUTES	37
20	EI-PVR	EXECUTIVE INTRUSION -PRIOR VALIDATION	INTRUSION CAPABILITY LEVEL	10
21	EI-R	EXECUTIVE INTRUSION -REQUEST	INTRUSION CAPABILITY LEVEL	10
22B	IPL-R	INTRUSION PROTECTION LEVEL-REQUEST	NONE	10

2 CODING OF SUPPLEMENTARY INFORMATION STRING IDENTIFIERS

ID CODE	MNEMONIC	SUPPLEMENTARY INFORMATION STRING NAME	PARAMETER	FIRST USE SECTION
23	IPL	INTRUSION PROTECTION LEVEL	INTRUSION PROTECTION LEVEL	10
24B	EI-C	EXECUTIVE INTRUSION-CONVERT	INTRUSION CAPABILITY LEVEL	14
25	EI-I	INTRUDED	NONE	10
26	CW	CALL WAITING	NONE	17
27	CO	CALL OFFER	NONE	14
28T	SN-REQ	SEND NEXT-REQUEST	NONE	6/189
29	HGF	HUNT GROUP FORWARDED	NESTING LEVEL	16
30B	DIV-V	DIVERSION-VALIDATION	NONE	11
31B	DIV-FM	DIVERSION-FOLLOW ME	C PARTY ADDRESS	11
32	DIV-BY	DIVERSION-BY PASS	NONE	11
33B	DIV-CI	DIVERSION CANCEL - IMMEDIATE	NONE	11
34B	DIV-CR	DIVERSION CANCEL - ON NO REPLY	NONE	11
35B	DIV-CB	DIVERSION CANCEL - ON BUSY	NONE	11
36B	DIV-CA	DIVERSION CANCEL - ALL	NONE	11
37F	DVG-I	DIVERTING IMMEDIATE	B PARTY ADDRESS	11
38F	DVG-B	DIVERTING ON BUSY	B PARTY ADDRESS	11
39F	DVG-R	DIVERTING ON NO REPLY	B PARTY ADDRESS	11

2 CODING OF SUPPLEMENTARY INFORMATION STRING IDENTIFIERS

ID CODE	MNEMONIC	SUPPLEMENTARY INFORMATION STRING NAME	PARAMETER	FIRST USE SECTION
40B	DVT-I	DIVERT IMMEDIATE	C PARTY ADDRESS	11
41B	DVT-B	DIVERT ON BUSY	C PARTY ADDRESS	11
42	DVD-I	DIVERTED IMMEDIATE	C PARTY ADDRESS	11
43	DVD-B	DIVERTED ON BUSY	C PARTY ADDRESS	11
44	DVD-R	DIVERTED ON NO REPLY	C PARTY ADDRESS	11
45	DVT-R	DIVERT ON NO REPLY	C PARTY ADDRESS	11
46	SIC	SERVICE INDICATOR CODE	SIC	7/189
47R	BSS-M	BEARER SERVICE SELECTION - Mandatory	SIC	18
48I	BSS-P	BEARER SERVICE SELECTION - Preferred	SIC	18
49I	BSS-N	BEARER SERVICE SELECTION - Notification	SIC	18
50	OLI/CLI	ORIGINATING LINE IDENTITY / CALLED LINE IDENTITY	A/B PARTY ADDRESS	6
51	RTI	ROUTING INFORMATION	(1) ROUTING INFORMATION (2) ISDN TYPE	6
52				
53	DVD-E	DIVERTED-EXTERNALLY	DIVERSION TYPE	11/189
54	REJ	REJECT	NONE	12
55	ACK	ACKNOWLEDGE	NONE	10
56	SN	SEND NEXT	NONE	6/189

2 CODING OF SUPPLEMENTARY INFORMATION STRING IDENTIFIERS

ID CODE	MNEMONIC	SUPPLEMENTARY INFORMATION STRING NAME	PARAMETER	FIRST USE SECTION
57A	D-SIC	DASS 2-SERVICE INDICATOR CODE	SIC	16/189
58 NOTE	NSI	NON-SPECIFIED INFORMATION	(1) NSI IDENTIFIER (2,3,ETC) AS DEFINED BY USER	15
59	OCP	ORIGINALLY CALLED PARTY	B-PARTY ADDRESS	5 ANNEX 4
60B	HOLD-REQ	HOLD REQUEST	NONE	12
61	RECON	RECONNECTED	NONE	12
62	HDG	HOLDING	NONE	5 ANNEX 4
63	CD-Q	CALL DISTRIBUTION-QUEUE	NONE	43
64B	TEXT-M	TEXT MESSAGE	TEXT	39
65	SOD-B	STATE OF DESTINATION-BUSY	NONE	9
66	SOD-F	STATE OF DESTINATION-FREE	NONE	9
67B 68	CD-DNQ	CALL DISTRIBUTION-DO NOT QUEUE	NONE	43
69B	CD-LINK	CALL DISTRIBUTION-LINKED	CALL INDEX	43
70B	DIV-RSI	DIVERSION-REMOTE SET IMMEDIATE	C PARTY ADDRESS	33
71B	DIV-RSB	DIVERSION-REMOTE SET ON BUSY	C PARTY ADDRESS	33
72B	DIV-RSR	DIVERSION-REMOTE SET ON NO REPLY	C PARTY ADDRESS	33
73B	DIV-RCI	DIVERSION-REMOTE CANCEL IMMEDIATE	NONE	33

NOTE: The NSI Code Suffix depends upon the Parameter contents.

2 CODING OF SUPPLEMENTARY INFORMATION STRING IDENTIFIERS

ID CODE	MNEMONIC	SUPPLEMENTARY INFORMATION STRING NAME	PARAMETER	FIRST USE SECTION
74B	DIV-RCB	DIVERSION-REMOTE CANCEL ON BUSY	NONE	33
75B	DIV-RCR	DIVERSION-REMOTE CANCEL ON NO REPLY	NONE	33
76B	DIV-RCA	DIVERSION-REMOTE CANCEL ALL	NONE	33
77B	PASSW	PASSWORD	PASSWORD	33
78B	SPL	SPLIT	NONE	13
79	TWP	TWO PARTY	CALL-DIR	13
80	ENQ	ENQUIRY CALL	HC-CLC	13
81F	SCE	SINGLE CHANNEL ENQUIRY	HC-CLC	13
82	TRFD	TRANSFERRED	CALL-DIR	13
83F	SHTL	SHUTTLE	NONE	13
84H	COC	CONNECTED CALL	NONE	13
85	TRFR	TRANSFER	NONE	13
86B	CD-FN	CALL DISTRIBUTION-FREE NOTIFY	CALL INDEX	43
87	ICC	INTERCOM CALL	NONE	16
88H	AD-RQ	ADD-ON REQUEST	NONE	13
89B	AD-V	ADD-ON VALIDATION	NONE	13
90	AD-O	ADDED-ON	NONE	13
91B	ENH	ENHANCED SSMF5	NONE	6/189
92	BAS	BASIC SSMF5	NONE	6/189
93B	CD-UNLINK	CALL DISTRIBUTION-UNLINKED	CALL INDEX	43
94	SNU	SIGNAL NOT UNDERSTOOD	ENHANCED STRING ID	5

2 CODING OF SUPPLEMENTARY INFORMATION STRING IDENTIFIERS

ID CODE	MNEMONIC	SUPPLEMENTARY INFORMATION STRING NAME	PARAMETER	FIRST USE SECTION
95	SU	SERVICE UNAVAILABLE	STRING ID	5
96	RR-SNU	RECALL REJECTED SIGNAL NOT UNDERSTOOD	ENHANCED STRING ID	5
97B	CD-CSU	CALL DISTRIBUTION-CALL SET UP	CALL INDEX	43
98	IG-SNU	IGNORED-SIGNAL NOT UNDERSTOOD	STRING ID LIST	5
99	IG-SU	IGNORED-SERVICE UNAVAILABLE	STRING ID LIST	18
100	TEXT	TEXTUAL DISPLAY	(1) TEXT (2) TEXT TYPE	16
101	SIM-A	SIMULATED ANSWER	NONE	6/189
102B	ACT	ACTIVATE	NONE	27
103B	DEACT	DEACTIVATE	NONE	27
104B	TCS	TRAFFIC-CHANNEL STATUS	CHANNEL STATUS	27
105B	CHID	CHANNEL IDENTITY	CHANNEL NUMBER	27
106B	FR-R	FORCED RELEASE - REQUEST	NONE	38
107J	PB-P	PRIORITY BREAKDOWN-PROTECTION	BPL	35
108	PB-R	PRIORITY BREAKDOWN-REQUEST	BCL	35
109	DI	DEVICE IDENTITY	DEVICE INDEX	43
110B	ROP-R	ROUTE OPTIMISATION - REQUEST	(1) CALL REFERENCE NUMBER (2) CALL IDENTITY LENGTH	19

2 CODING OF SUPPLEMENTARY INFORMATION STRING IDENTIFIERS

ID CODE	MNEMONIC	SUPPLEMENTARY INFORMATION STRING NAME	PARAMETER	FIRST USE SECTION
111H	ROP-CSU	ROUTE OPTIMISATION - CALL SET UP	CALL IDENTITY LENGTH	19
112B	ROP-CON	ROUTE OPTIMISATION - CONNECTED	NONE	19
113	DND	DO NOT DISTURB	1) STATE OF DESTINATION 2) STATE OF DESTINATION QUALIFIER	32
114	DND-O	DO NOT DISTURB-OVERRIDE	NONE	32
115B	DND-S	DO NOT DISTURB-SET	NONE	34
116B	DND-C	DO NOT DISTURB-CLEAR	NONE	34
117				
118B	EST	EXTENSION STATUS CALL	NONE	20
119	CDIV	CONTROLLED DIVERSION	NONE	21
120	RDG	REDIRECTING	REASON FOR REDIRECTING	22
121	RCF	REDIRECTING ON CALL FAILURE	(1) CLEARING CAUSE and (2) B PARTY ADDRESS	22
122H	TOV-R	TAKEOVER REQUEST	NONE	24
123B	TOV-V	TAKEOVER VALIDATION	NONE	24
124B	SER-R	SERIES CALL REQUEST	RECONNECT ADDRESS	23
125	SER-C	SERIES CALL-CANCEL	NONE	23
126	SER-E	SERIES CALL -ESTABLISHMENT	NONE	23
127B	NS-N	NIGHT SERVICE - NOTIFICATION	STATE OF OPERATOR	25

2 CODING OF SUPPLEMENTARY INFORMATION STRING IDENTIFIERS

ID CODE	MNEMONIC	SUPPLEMENTARY INFORMATION STRING NAME	PARAMETER	FIRST USE SECTION
128A	NS-DVT	NIGHT SERVICE-DIVERT	(1) NIGHT SERVICE ADDRESS (2)PBX FLAG	25
129	NS-DVG	NIGHT SERVICE - DIVERTING	NONE	25
130	NS-DVD	NIGHT SERVICE - DIVERTED	C PARTY ADDRESS	25
131	NS-RDVT	NIGHT SERVICE - REDIVERT	C PARTY ADDRESS	25
132	NS-RDVG	NIGHT SERVICE - REDIVERTING	NONE	25
133	NS-RDVD	NIGHT SERVICE - REDIVERTED	C PARTY ADDRESS	25
134	NS-DA	NIGHT SERVICE - DEACTIVATED	NONE	25
135	Q-INFO	QUEUE INFORMATION	(1) NUMBER OF CALLS & (2) NUMBER OF SERVERS	16
136	Q-PRIO	QUEUE PRIORITY	PRIORITY LEVEL	16
137T	SW-V	SWAP - VALIDATION	NONE	8
138	SW-R	SWAP - REJECTED	LOCATION	8
139				
140	A2	SSMF5 SIGNAL 'A-2'	NONE	6/189
141				
142	A5	SSMF5 SIGNAL 'A-5'	NONE	6/189
143				
144	A8	SSMF5 SIGNAL 'A-8'	NONE	6/189

2 CODING OF SUPPLEMENTARY INFORMATION STRING IDENTIFIERS

ID CODE	MNEMONIC	SUPPLEMENTARY INFORMATION STRING NAME	PARAMETER	FIRST USE SECTION
145	A10	SSMF5 SIGNAL 'A-10'	NONE	6/189
146				
147	A13	SSMF5 SIGNAL 'A-13'	NONE	6/189
148	A14	SSMF5 SIGNAL 'A-14'	NONE	6/189
149	A12	SSMF5 SIGNAL 'A-12'	NONE	6/189
150	A7	SSMF5 SIGNAL 'A-7'	NONE	6/189
151B	CBWF-CLB	CALL BACK WHEN FREE-CALL BACK	NONE	9/189
152B	DVT	DIVERT	C PARTY ADDRESS	11/189
153	SOD-I	STATE OF DESTINATION-INDETERMINABLE	NONE	11/189
154	DVG	DIVERTING	B PARTY ADDRESS	11/189
155B	SOD-REQ	REQUEST STATE OF DESTINATION	NONE	11/189
156B	CBWF-CB	CALL BACK WHEN FREE-CALL BACK REQUEST	NONE	9/189
157A	NAE-DC	NETWORK ADDRESS EXTENSION -DESTINATION COMPLETE	SUBADDRESS	41
158	SFI	SUPPLEMENTARY FACILITIES INHIBITED	NONE	35
159A	NAE-DI	NETWORK ADDRESS EXTENSION -DESTINATION INCOMPLETE	SUBADDRESS	41
160	DRS	DIRECT ROUTE SELECT	NONE	16
161B	AS	ALARM STATUS	(1) ALARM LEVEL (2) STAFF PRESENT	28
162B	AS-R	ALARM STATUS-REQUEST	NONE	28

2 CODING OF SUPPLEMENTARY INFORMATION STRING IDENTIFIERS

ID CODE	MNEMONIC	SUPPLEMENTARY INFORMATION STRING NAME	PARAMETER	FIRST USE SECTION
163B	TAD-R	TIME AND DATE-REQUEST	NONE	30
164B	TAD	TIME AND DATE	TIME AND DATE (6 PARAMETERS)	30
165	SATB	SATELLITE BARRED	NONE	16
166	SERV	SERVICE INFORMATION	SERVICES	16
167	TID	TRUNK IDENTITY	(1) PBX REFERENCE NUMBER (2) TRUNK GROUP REF NUMBER (3) TRUNK MEMBER REF NUMBER	16
168B	PARK	PARK REQUEST	NONE	42
169	PKD	PARKED	NONE	42
170	AC-NAO	ADD-ON CONFERENCE-NO ADD ON CURRENTLY AVAILABLE	NONE	29
171B	CBM-R	CALL BACK MESSAGING -REQUEST	NONE	36
172B	CBM-C	CALL BACK MESSAGING -CANCEL	NONE	36
173	NAE-CC	NETWORK ADDRESS EXTENSION -CALLING/CALLED IDENTITY COMPLETE	SUBADDRESS	16
174	NAE-CI	NETWORK ADDRESS EXTENSION -CALLING/CALLED IDENTITY INCOMPLETE	SUBADDRESS	16
175				
176B	AC-CDC	ADD-ON CONFERENCE-CLEAR-DOWN CONFERENCE	NONE	13

2 CODING OF SUPPLEMENTARY INFORMATION STRING IDENTIFIERS

ID CODE	MNEMONIC	SUPPLEMENTARY INFORMATION STRING NAME	PARAMETER	FIRST USE SECTION
177 178	AC-PI	ADD-ON CONFERENCE-PARTY INDEX	CONFERENCE PARTY INDEX	13
179B	AC-DR	ADD-ON CONFERENCE-DETAILS REQUEST	NONE	29
180	AC-PD	ADD-ON CONFERENCE-PARTY DETAILS	CONFERENCE PARTY DETAILS	29
181	AC-CBI	ADD-ON CONFERENCE-CONFERENCE BRIDGE IDENTITY	CONFERENCE BRIDGE ADDRESS	29
182	CH-AC	CHARGE REPORTING-ACCOUNT CODE	ACCOUNT CODE	40
183B	CH-ACR	CHARGE REPORTING-ACCOUNT CODE REQUEST	NONE	40
184	CH-ACT	CHARGE REPORTING-ACTIVE	NONE	40
185B	CH-CLR	CHARGE REPORTING-CLEAR	NONE	40
186B	CH-CR	CHARGE REPORTING-COST REQUEST	NONE	40
187	CH-CST	CHARGE REPORTING-COST	(1) CURRENCY UNITS (2) COST QUALIFIER (3) CURRENCY INDICATION	40
188	CH-TR	CHARGE REPORTING-TIME RATE	(1) CURRENCY UNITS (2) TIME INTERVAL (3) COST QUALIFIER (4) CURRENCY INDICATION	40

2 CODING OF SUPPLEMENTARY INFORMATION STRING IDENTIFIERS

ID CODE	MNEMONIC	SUPPLEMENTARY INFORMATION STRING NAME	PARAMETER	FIRST USE SECTION
189	CH-UR	CHARGE REPORTING-UNIT RATE	(1) CURRENCY UNITS (2) COST QUALIFIER (3) CURRENCY INDICATION	40
190	CH-UU	CHARGE REPORTING-UNITS USED	UNITS	40
191	OPD	OUTPUT DIGITS	REMOTE ADDRESS	40/189
192B	OPD-R	OUTPUT DIGITS - REQUEST	NONE	40/189
193	IRD	INTERNAL REROUTING DISABLED	NONE	16
194	ERD	EXTERNAL REROUTING DISABLED	NONE	16
195B	NLT-PT	NON-LOOPED BACK TEST - PERFORM TEST	TEST INDEX	27
196B	NLT-RQ	NON-LOOPED BACK TEST - TEST REQUEST	TEST INDEX	27
197B	NLT-SC	NON-LOOPED BACK TEST - SEQUENCE COMPLETE	NONE	27
198B	NLT-RES	NON-LOOPED BACK TEST - RESULT	TEST RESULT	27
199	AUTO-A	AUTOANSWER	NONE	16
200	HF-A	HANDS-FREE - ACTIVATED	NONE	16
201	HF-D	HANDS-FREE - DEACTIVATED	NONE	16
202B	EI-W	EXECUTIVE INTRUSION - WITHDRAW	NONE	10
203	DVT-RD	DIVERT-REDIRECTION	(1) REASON FOR RE-DIRECTING (2) C PARTY ADDRESS	22

2 CODING OF SUPPLEMENTARY INFORMATION STRING IDENTIFIERS

ID CODE	MNEMONIC	SUPPLEMENTARY INFORMATION STRING NAME	PARAMETER	FIRST USE SECTION
204	DVT-CF	DIVERT-CALL FAILURE	C PARTY ADDRESS	22
205	ASST-INFO	ASSISTANCE-INFORMATION	TYPE OF ASSISTANCE	16
206	RED-BY	REDIRECTION-BYPASS	NONE	22
207				
208	VIC	VPN INITIATED CLEAR	NONE	16
209 NOTE	NPR-A	NUMBER PRESENTATION RESTRICTION-A PARTY	RESTRICTION DOMAIN	48
210 NOTE	NPR-B	NUMBER PRESENTATION RESTRICTION-B PARTY	RESTRICTION DOMAIN	48
211	ARC	AUXILIARY ROUTE RESTRICTION CLASS	ROUTE RESTRICTION CLASS	16
212	WOB	WAIT ON BUSY	NONE	45
213B	GPU-R	GROUP PICK-UP REQUEST	GROUP PICK-UP CODE	46
214B	PU-DVT	PICK-UP DIVERT	1)C-PARTY ADDRESS 2)TIME INTERVAL	46
215B	PU-DVG	PICK-UP DIVERTING	TIME INTERVAL	46
216B	DPU-R	DIRECTED PICK-UP REQUEST	PICK-UP CALL TYPE	46
217	RCC-CA	ROUTE CAPACITY CONTROL - CAPACITY AVAILABLE	NONE	44
218				

NOTE: The NPR-A and NPR-B String Identifier Codes shall have no Suffix, an "A" Suffix or a B" Suffix depending on the requirements of a network with respect to how PBXs that do not recognise NPR-A or NPR-B should be forced to respond to their receipt.

2 CODING OF SUPPLEMENTARY INFORMATION STRING IDENTIFIERS

ID CODE	MNEMONIC	SUPPLEMENTARY INFORMATION STRING NAME	PARAMETER	FIRST USE SECTION
219	RCC-OI	ROUTE CAPACITY CONTROL - OVERRIDE INVOKED	NONE	44
220	PU-DVD	PICK-UP DIVERTED	NONE	46
221 NOTE	NPR-O	NUMBER PRESENTATION RESTRICTION - OTHER PARTY	RESTRICTION DOMAIN	48
222K	MCI	MALICIOUS CALL INDICATION	MALICIOUS CALL REFERENCE	16
223	NSL	NETWORK SIGNALLING LIMIT	NONE	16
224				
225				
226	TCOS	TRAVELLING CLASS OF SERVICE	(1)ROUTE RESTRICTION CLASS (2)CALL BARRING GROUP (3)FACILITY LIST CODE	47
227B	TCOS-R	TRAVELLING CLASS OF SERVICE-REQUEST	NONE	47
228B	DIV-RSC	DIVERSION-REMOTE SET COMBINED	C PARTY ADDRESS	33
229B	DIV-RCC	DIVERSION-REMOTE CANCEL COMBINED	NONE	33
230	RDC	REDIRECTION CONTROL	TIMER VALUE	16
231	CAUSE	CLEARING CAUSE	CLEARING CAUSE	6

NOTE: The NPR-O String Identifier Code shall have no Suffix, an "A" Suffix or a B" Suffix depending on the requirements of a network with respect to how PBXs that do not recognise NPR-O should be forced to respond to its receipt.

2 CODING OF SUPPLEMENTARY INFORMATION STRING IDENTIFIERS

ID CODE	MNEMONIC	SUPPLEMENTARY INFORMATION STRING NAME	PARAMETER	FIRST USE SECTION
232	CP	CALL PROCEEDING	NONE	6/189-I
233 NOTE	I-BC	ISDN-BEARER CAPABILITY	BEARER CAPABILITY	6/189-I
234	I-CC	ISDN-CLEARING CAUSE	CAUSE	6/189-I
235	I-CPN	ISDN-CALLING PARTY /CONNECTED NUMBER	1) ISDN NUMBER ATTRIBUTES 2) ISDN NUMBER DIGITS	6/189-I
236A	I-CSA	ISDN-CALLING PARTY /CONNECTED SUBADDRESS	ISDN SUBADDRESS	6/189-I
237A	I-DSA	ISDN-DESTINATION (CALLED PARTY) SUBADDRESS	ISDN SUBADDRESS	6/189-I
238	I-HLC	ISDN-HIGH LAYER COMPATIBILITY	HIGH LAYER COMPATIBILITY	6/189-I
239 NOTE	I-LLC	ISDN-LOW LAYER COMPATIBILITY	LOW LAYER COMPATIBILITY	6/189-I
240	I-PROG	ISDN-PROGRESS	PROGRESS INDICATOR (may be repeated)	6/189-I
241	IPN	INTERWORKING VIA A PRIVATE ISDN	NONE	6/189-I
242	SAVE	SAVE	NONE	6/189-I
243	V-NID	VPN-NODAL IDENTITY	VPN ACCESS REFERENCE NUMBER	16

NOTE: This String Identifier Code shall have no Suffix or a "B" Suffix depending on the outcome of attempting to generate a SIC from Bearer Capability and/or Low Layer Compatibility (see DPNSS[189-I] SECTION 4, ANNEX 2 and SECTION 6).

2 CODING OF SUPPLEMENTARY INFORMATION STRING IDENTIFIERS

ID CODE	MNEMONIC	SUPPLEMENTARY INFORMATION STRING NAME	PARAMETER	FIRST USE SECTION
244	M-INDEX	MESSAGE INDEX	INDEX NUMBER	16
245	CBM-CSU	CALL BACK MESSAGING-CALL SET-UP	NONE	36
246A	INT-A	INTERIM ANSWER	NONE	16
247				
248	DVL	DIVERSION - LAST CONTROLLING EXTENSION IDENTITY	(1) B PARTY ADDRESS (2) DIVERSION TYPE (3) RESTRICTION INDICATOR	11
249	ROP-INV	ROUTE OPTIMISATION INVITE	NONE	16
250A	ROP-INVA	ROUTE OPTIMISATION INVITE WITH ACKNOWLEDGEMENT	NONE	19
251	PCLG-P	PUBLIC CALLING PARTY NUMBER - PROVIDED	(1) ISDN NUMBER ATTRIBUTES (2) ISDN NUMBER DIGITS	16
252	PCLG-D	PUBLIC CALLING PARTY NUMBER - DEFAULT	NONE	16
253	PCON-P	PUBLIC CONNECTED NUMBER - PROVIDED	(1) ISDN NUMBER ATTRIBUTES (2) ISDN NUMBER DIGITS	16
254	PCON-D	PUBLIC CONNECTED NUMBER - DEFAULT	NONE	16

3 CODING OF SUPPLEMENTARY INFORMATION STRING PARAMETERS

PARAMETER NAME	DESCRIPTION AND CODING																		
ACCOUNT CODE	This Parameter comprises a sequence of IA5 numeric characters representing an account code.																		
ALARM LEVEL	<p>The Alarm Level shall always contain an IA5 numeric character in the range 0-4, optionally followed by an IA5 alpha character.</p> <p>The first character shall be used as follows:</p> <table border="1" data-bbox="564 840 1477 1581"> <thead> <tr> <th>Value</th> <th>Name</th> <th>Description</th> </tr> </thead> <tbody> <tr> <td>0</td> <td>None</td> <td>No alarms currently active in the system</td> </tr> <tr> <td>1</td> <td>Low</td> <td>Some alarms active, but no effect on traffic handling</td> </tr> <tr> <td>2</td> <td>Medium</td> <td>Some alarms active which do have an effect on traffic handling, but the PBX can still function</td> </tr> <tr> <td>3</td> <td>High</td> <td>Alarms active in the system are such that the PBX operation is greatly affected</td> </tr> <tr> <td>4</td> <td>Alarm reporting inhibited</td> <td>No alarm information shall be provided because maintenance personnel on site have inhibited the reporting of alarms</td> </tr> </tbody> </table> <p>The precise details of when each category is used is dependent upon the PBX design</p> <p>The optional alpha character shall be the letter "P" to indicate that the mains power supply has failed. If this is not present it shall be assumed that power is available.</p>	Value	Name	Description	0	None	No alarms currently active in the system	1	Low	Some alarms active, but no effect on traffic handling	2	Medium	Some alarms active which do have an effect on traffic handling, but the PBX can still function	3	High	Alarms active in the system are such that the PBX operation is greatly affected	4	Alarm reporting inhibited	No alarm information shall be provided because maintenance personnel on site have inhibited the reporting of alarms
Value	Name	Description																	
0	None	No alarms currently active in the system																	
1	Low	Some alarms active, but no effect on traffic handling																	
2	Medium	Some alarms active which do have an effect on traffic handling, but the PBX can still function																	
3	High	Alarms active in the system are such that the PBX operation is greatly affected																	
4	Alarm reporting inhibited	No alarm information shall be provided because maintenance personnel on site have inhibited the reporting of alarms																	

3 CODING OF SUPPLEMENTARY INFORMATION STRING PARAMETERS

PARAMETER NAME	DESCRIPTION AND CODING
A PARTY ADDRESS	<p>In general the A Party Address is a digit sequence that represents the address of the originating caller. The precise meaning of the A Party Address Parameter is subject to the CLC of the calling party.</p> <p>When the A Party is CLC-ORD or CLC-OP then the A Party Address is that digit sequence which, when used as a DPNSS 1 Destination Address by any PBX in the network, will cause a call to be routed to the originating extension or operator.</p> <p>When the A Party is CLC-ISDN, then the A Party Address shall be a sequence of digits that, if sent as a destination address to the public network via an access at the Gateway PBX where the call crossed the public network boundary, would cause a call to be routed via the public network to that party. In the case of an ETS 300 102 access, the digit sequence shall be that which would be associated with Numbering Plan Identification and Type of Number, "Unknown".</p> <p>Depending on the type of number (eg local or national) and the topology of the private network, an A Party Address associated with CLC-ISDN may also be valid at other public network accesses. It is therefore recommended that an A Party Address sent by a PBX should have the widest possible significance throughout the private network. For example, in the case of a private network within the UK, the full national number including the "0" prefix should be used.</p> <p>NOTE: Before it can form a DPNSS 1 Destination Address, an A Party Address associated with CLC-ISDN may need to be prefixed with digits to Cause routing to a Gateway PBX.</p> <p>When the A Party is CLC-MF5 then the meaning of the A Party Address depends upon the numbering plan employed by the private network:</p> <ul style="list-style-type: none">- if the DPNSS 1 and SSMF5 parts of the network share a global numbering plan then the A Party Address is that digit sequence which, when used as a Destination Address in a DPNSS ISRM, will cause a call to be routed to the originating SSMF5 extension;

3 CODING OF SUPPLEMENTARY INFORMATION STRING PARAMETERS

PARAMETER NAME	DESCRIPTION AND CODING
A PARTY ADDRESS (CONTINUED)	<p>- if the DPNSS 1 and SSMF5 parts of the network have separate numbering plans then the A Party Address is that digit sequence which, when sent via an SSMF5 route, will cause a call to be routed to the originating SSMF5 extension (NOTE: Under these circumstances when the A Party Address is used as a Destination Address in a DPNSS 1 ISRM, it must be prefixed in order first to route the call to the SSMF5 Gateway).</p> <p>When the A Party is CLC-PSTN or CLC-DEC the address of the calling party will not be available. Some PBXs conforming to earlier versions of the specification may use the A Party Address Parameter to convey the Trunk Number. No standardised method of coding the Trunk Number is specified; this has to be mutually agreed at network configuration.</p> <p>The A Party Address comprises a sequence of IA5 numeric characters, each in the range 0-9. The numbers are sent most significant first.</p> <p>example: Originating Line Identity = 5892 would be encoded as: *50*5892#</p>
BEARER CAPABILITY	<p>This Parameter comprises a sequence of IA5 characters representing the values of octets 3, onwards of an ISDN Bearer Capability information element, using 3B4I encoding (see Subsection 5 of this Annex).</p> <p>example: The following Bearer Capability information element:</p> <p>Octet 1: identifier Octet 2: length Octet 3: 10010000 Octet 4: 10010000 Octet 5: 10100011</p> <p>would be encoded as: *233*dIBc#</p>

3 CODING OF SUPPLEMENTARY INFORMATION STRING PARAMETERS

PARAMETER NAME	DESCRIPTION AND CODING
B PARTY ADDRESS	<p>In general the B Party Address is a digit sequence that represents the address of the second party in a call, eg the originally called party in the case of Diversion. The precise meaning of the B Party Address Parameter is subject to the CLC of the second party.</p> <p>When the B Party is CLC-ORD or CLC-OP then the B Party Address is that digit sequence which, when used as a DPNSS 1 Destination Address by any PBX in the network, will cause a call to be routed to the associated extension or operator.</p> <p>When the B Party is CLC-ISDN, then the B Party Address shall be a sequence of digits that, if sent as a destination address to the public network via an access at the Gateway PBX where the call crossed the public network boundary, would cause a call to be routed via the public network to that party. In the case of an ETS 300 102 access, the digit sequence shall be that which would be associated with Numbering Plan Identification and Type of Number, "Unknown".</p> <p>Depending on the type of number (eg local or national) and the topology of the private network, a B Party Address associated with CLC-ISDN may also be valid at other public network accesses. It is therefore recommended that a B Party Address sent by a PBX should have the widest possible significance throughout the private network. For example, in the case of a private network within the UK, the full national number including the "0" prefix should be used.</p> <p>NOTE: Before it can form a DPNSS 1 Destination Address, a B Party Address associated with CLC-ISDN may need to be prefixed with digits to cause routing to a Gateway PBX.</p> <p>When the B Party is CLC-MF5 then the meaning of the B Party Address depends upon the numbering plan employed by the private network:</p> <ul style="list-style-type: none">- if the DPNSS 1 and SSMF5 parts of the network share a global numbering plan then the B Party Address is that digit sequence which, when used as a Destination Address in a DPNSS ISRM, will cause a call to be routed to the called SSMF5 extension;

3 CODING OF SUPPLEMENTARY INFORMATION STRING PARAMETERS

PARAMETER NAME	DESCRIPTION AND CODING
<p>B PARTY ADDRESS (CONTINUED)</p>	<p>- if the DPNSS 1 and SSMF5 parts of the network have separate numbering plans then the B Party Address is that digit sequence which, when sent via an SSMF5 route, will cause a call to be routed to the originating SSMF5 extension (NOTE: Under these circumstances when the B Party Address is used as a Destination Address in a DPNSS 1 ISRM, it must be prefixed in order first to route the call to the SSMF5 Gateway).</p> <p>When the B Party is CLC-PSTN or CLC-DEC the address of the called party will not be available. Some PBXs conforming to earlier versions of the specification may use the B Party Address Parameter to convey the Trunk Number. No standardised method of coding the Trunk Number is specified and this has to be mutually agreed at network configuration.</p> <p>The B Party Address comprises a sequence of IA5 numeric characters, each in the range 0-9. The numbers are sent most significant first.</p> <p>example: Diverting from address 1212 on busy.</p> <p>would be encoded as: *38F*1212#</p>
<p>BREAKDOWN CAPABILITY LEVEL</p>	<p>This Parameter is used to set the capability level of a call which may be used to breakdown an existing call.</p> <p>The Parameter comprises a decimal number coded as up to two IA5 numeric characters in the Range 0-15.</p>
<p>BREAKDOWN PROTECTION LEVEL</p>	<p>This Parameter is used to set the protection level of a call to guard against subsequent attempts made to break down the call.</p> <p>The Parameter comprises a decimal number coded as up to two IA5 numeric characters in the Range 0-15.</p>
<p>BUSY SERVICES</p>	<p>This Parameter has been renamed "SERVICES".</p>

3 CODING OF SUPPLEMENTARY INFORMATION STRING PARAMETERS

PARAMETER NAME	DESCRIPTION AND CODING
CALL BARRING GROUP	<p>The Call Barring Group Parameter indicates the party's entitlement to make calls to or receive calls from other parties</p> <p>It comprises a decimal number (from 0 upwards), coded as one or more IA5 numeric characters, or the null value for this Parameter which is coded as the IA5 character, hyphen (2/13).</p>
CALL-DIR	<p>This Parameter assigns a direction to a call, to provide a datum for subsequent Supplementary Service requests.</p> <p>It comprises a single IA5 character as follows:</p> <p style="text-align: center;">O = Originating PBX T = Terminating PBX</p>
CALL IDENTITY LENGTH	<p>This parameter comprises a decimal number coded as a sequence of IA5 characters indicating the length of a call identity. When used in conjunction with ROP-R it indicates how many of the digits in the Call Reference Number parameter identify the call being optimised, ie the number of digits in the parameter excluding the number of digits that comprise the network address of the Originating PBX. When used in conjunction with ROP-CSU, it similarly indicates how many of the digits in the Destination Address identify the call being optimised.</p> <p>This parameter is optional.</p> <p>example: *110B*78005*2# indicates that the Call Reference Number Parameter 78005 is made up of a network address of 780 and a call identity of 05.</p>

3 CODING OF SUPPLEMENTARY INFORMATION STRING PARAMETERS

PARAMETER NAME	DESCRIPTION AND CODING
CALL INDEX	This Parameter is a non-zero decimal number coded as up to 3 IA5 numeric characters used to identify a queued call. This Parameter is optional.
CALL REFERENCE NUMBER	That digit sequence which, when used as a Destination Address will cause routing back to the PBX which has requested route optimisation and, on arrival at that PBX, identifies the call being optimised.
CAUSE	<p>This Parameter comprises a sequence of IA5 characters representing the values of octets 3, onwards of an ISDN Cause information element, using 3B4I encoding (see Subsection 5 of this Annex).</p> <p>example: The following Cause information element:</p> <p style="padding-left: 40px;">Octet 1: identifier Octet 2: length Octet 3: 10000000 Octet 4: 10010000</p> <p style="padding-left: 40px;">would be encoded as: *234*`I@#</p>
CHANNEL NUMBER	<p>This Parameter is used to identify a specific traffic channel.</p> <p>The Channel Number is encoded as its 5-bit binary equivalent but is transmitted as an IA5 character in accordance with the following table.</p> <p>On receipt of this Parameter the Terminating PBX discards bits 6 and 7 of the IA5 character and uses the remaining 5 bits to identify the Channel Number as in the following table.</p>

3 CODING OF SUPPLEMENTARY INFORMATION STRING PARAMETERS

PARAMETER NAME	DESCRIPTION AND CODING		
CHANNEL NUMBER (CONTINUED)	5 BIT BLOCK MSB LSB	IA5 CHARACTER	CHANNEL NUMBER
	0 0 0 0 0	@	Not Used
	0 0 0 0 1	A	1
	0 0 0 1 0	B	2
	0 0 0 1 1	C	3
	0 0 1 0 0	D	4
	0 0 1 0 1	E	5
	0 0 1 1 0	F	6
	0 0 1 1 1	G	7
	0 1 0 0 0	H	8
	0 1 0 0 1	I	9
	0 1 0 1 0	J	10
	0 1 0 1 1	K	11
	0 1 1 0 0	L	12
	0 1 1 0 1	M	13
	0 1 1 1 0	N	14
	0 1 1 1 1	O	15
	1 0 0 0 0	P	16
	1 0 0 0 1	Q	17
	1 0 0 1 0	R	18
	1 0 0 1 1	S	19
	1 0 1 0 0	T	20
	1 0 1 0 1	U	21
	1 0 1 1 0	V	22
	1 0 1 1 1	W	23
	1 1 0 0 0	X	24
	1 1 0 0 1	Y	25
	1 1 0 1 0	Z	26
	1 1 0 1 1	[27
	1 1 1 0 0	\	28
	1 1 1 0 1]	29
	1 1 1 1 0	^	30
	1 1 1 1 1	_	31
CHANNEL STATUS	<p>The status of the traffic channel is identified by a single IA5 character allocated as follows:</p> <ul style="list-style-type: none"> 1 Free 2 Busy 3 Not equipped 4 Back-Busied by Me 5 Back-Busied by You 6 Looped-Back by Me 7 Looped-Back by You 8 Out of Service 		

3 CODING OF SUPPLEMENTARY INFORMATION STRING PARAMETERS

PARAMETER NAME	DESCRIPTION AND CODING
CHANNEL STATUS (CONTINUED)	<p>Further values may be added in future issues of DPNSS[188], DPNSS[189] and DPNSS[189-I].</p> <p>Where more than one condition applies they shall all be included in the Parameter, separated by the IA5 character space (2/0).</p> <p>If the status is indicated as "Not Equipped" or "Out of Service", no other status may be given.</p> <p>The status "Free" may not accompany the status "Busy", "Looped-Back by Me" or "Looped-Back by You".</p> <p>The status "Busy" may not accompany the status "Free", "Looped-Back by Me" or "Looped-Back by You".</p> <p>The status "Looped-Back by Me" may not accompany the status "Looped-Back by You".</p>
CLEARING CAUSE	<p>This Parameter comprises a pair of IA5 characters representing the value of the Clearing Cause octet received in a CRM, using 1B2I encoding (see Subsection 5 of this Annex).</p> <p>example: the Clearing Cause: Busy (08H)</p> <p>would be received in a CRM as octet: 00001000</p> <p>- when used as a Parameter to String RCF, would be encoded as: *121*@H*1234# (ie Redirecting on Call Failure [CC: Busy] to B Party Address 1234)</p>
CONFERENCE BRIDGE ADDRESS	<p>The Conference Bridge Address is that digit sequence which, when used as a Destination Address, will cause routing back to the Conference PBX and, on arrival at that PBX, will identify the particular conference bridge or group.</p>

3 CODING OF SUPPLEMENTARY INFORMATION STRING PARAMETERS

PARAMETER NAME	DESCRIPTION AND CODING
CONFERENCE PARTY DETAILS	<p>This Parameter comprises any combination of the following details coded in IA5 alpha characters as indicated:</p> <p>C = Controller L = Last S = Self</p> <p>If none of these details applies this Parameter may be omitted.</p>
CONFERENCE PARTY INDEX	<p>This Parameter comprises a decimal number encoded as one or more IA5 numeric characters.</p>
COST QUALIFIER	<p>This Parameter consists of an IA5 character indicating how any charging data received is to be qualified as follows:</p> <p>0 = VAT not included. 1 = Supplementary charges not included.</p> <p>Further values may be defined in future issues of DPNSS[188], DPNSS[189] and DPNSS[189-I].</p> <p>If more than one qualification applies, they shall all be included, separated by the IA5 character space (2/0).</p> <p>Example: *187*253*0 1*A# (Note: "A" = CURRENCY INDICATION Parameter)</p> <p>This represents a call cost of £2-53 excluding VAT and supplementary charges.</p> <p>If no qualifications apply, the Parameter shall be coded as the IA5 character, hyphen (2/13).</p> <p>Where no qualifications apply, charging data received may be assumed to indicate the total cost of the call. Where supplementary charges are not included, the precise significance of this is dependent on the charging source.</p>

3 CODING OF SUPPLEMENTARY INFORMATION STRING PARAMETERS

PARAMETER NAME	DESCRIPTION AND CODING
C PARTY ADDRESS	<p>That digit sequence which, when used as a Destination Address by any PBX in the network, will cause the call to be routed to the third party in a call eg, diverted-to party in the case of diversion.</p> <p>The C Party Address comprises a sequence of IA5 Numeric characters, each in the range 0-9. The numbers are sent most significant first.</p> <p>Example: *40B*3678#</p> <p>Divert this call to address 3678</p> <p>In the case of Remote Registration of Diversion Strings DIV-RSB/-RSC/-RSI/-RSR this Parameter is optional.</p>
CURRENCY INDICATION	<p>This Parameter comprises a single IA5 character which indicates the currency in which any associated currency units are specified.</p> <p>A = Pence (UK)</p> <p>Further values may be defined in future issues of DPNSS[188], DPNSS[189] and DPNSS[189-I].</p> <p>This Parameter is optional. If not present, a default currency must be assumed.</p>
CURRENCY UNITS	<p>This Parameter comprises a sequence of IA5 numeric characters or a sequence of IA5 numeric characters followed by another IA5 character sequence consisting of the IA5 character "dot" (2/14) and a sequence of IA5 numeric characters. This Parameter represents monetary cost, in the units of the given or assumed currency, to N decimal places, where N is the number of numeric characters in the second sequence (N=0 if the second sequence is not present).</p>
DEVICE INDEX	<p>This Parameter is a decimal number coded as up to 2 IA5 numeric characters which can be used to sub-divide a DA, OLI, or CLI in order to identify uniquely a particular device.</p>

3 CODING OF SUPPLEMENTARY INFORMATION STRING PARAMETERS

PARAMETER NAME	DESCRIPTION AND CODING
DIVERSION TYPE	<p>This Parameter indicates the type of diversion used.</p> <p>It comprises a single IA5 character, used as follows:</p> <p>I = Diversion Immediate B = Diversion On Busy R = Diversion On No Reply</p>
ENHANCED STRING ID	<p>Enhanced String ID comprises a copy of the IA5 numerals and suffix letter of one Supplementary Information String Identifier or a single IA5 alpha character, indicating one of the following:</p> <p>A = Unrecognised Maintenance Action E = Syntax Error F = Selection Block capacity exceeded M = Missing Information R = Recall not supported S = Unrecognised SIC</p> <p>example 1: *94*22B#</p> <p>The request for intrusion protection level was not understood</p> <p>example 2: *94*E#</p> <p>Syntax Error</p> <p>In the case of NSI Strings however, it is necessary to allow for the first Parameter of the NSI String to be included as part of the Parameter "Enhanced String ID". In this case the NSI Parameter is separated from the ID (58) and suffix by a semicolon.</p> <p>Example: *94*58B;AA#</p> <p>The String 58B*AA was not understood.</p>

3 CODING OF SUPPLEMENTARY INFORMATION STRING PARAMETERS

PARAMETER NAME	DESCRIPTION AND CODING								
FACILITY LIST CODE	<p>The Facility List Code Parameter indicates the facilities the party is allowed to use.</p> <p>It comprises a decimal number (from 0 upwards), coded as one or more IA5 numeric characters, or the null value which is the IA5 character, hyphen (2/13).</p>								
GROUP PICK-UP CODE	<p>The Group Pick-Up Code is a Parameter which indicates a network-wide group of extensions.</p> <p>It comprises a decimal number (from 0 upwards), coded as one or more IA5 numeric characters.</p>								
HC-CLC	<p>The Parameter HC-CLC gives the Called/Calling Line Category of the held party.</p> <p>This Parameter comprises a single IA5 numeric character allocated as follows:</p> <table data-bbox="539 1111 1433 1173"> <tr> <td>1 = Ordinary</td> <td>2 = Decadic</td> <td>3 = ISDN</td> </tr> <tr> <td>4 = PSTN</td> <td>5 = SSMF5</td> <td>6 = Operator</td> </tr> </table> <p>APPENDIX 1Conference</p> <p>example: *80*1# Enquiry call with an ordinary extension on hold.</p>	1 = Ordinary	2 = Decadic	3 = ISDN	4 = PSTN	5 = SSMF5	6 = Operator		
1 = Ordinary	2 = Decadic	3 = ISDN							
4 = PSTN	5 = SSMF5	6 = Operator							
HIGH LAYER COMPATIBILITY	<p>This Parameter comprises a sequence of IA5 characters representing the values of octets 3, onwards of an ISDN High Layer Compatibility information element, using 3B4I encoding (see Subsection 5 of this Annex).</p> <p>Example: The following High Layer Compatibility information element:</p> <table data-bbox="715 1626 1123 1749"> <tr> <td>Octet 1:</td> <td>identifier</td> </tr> <tr> <td>Octet 2:</td> <td>length</td> </tr> <tr> <td>Octet 3:</td> <td>10010001</td> </tr> <tr> <td>Octet 4:</td> <td>10000100</td> </tr> </table> <p>would be encoded as: *238*dXP#</p>	Octet 1:	identifier	Octet 2:	length	Octet 3:	10010001	Octet 4:	10000100
Octet 1:	identifier								
Octet 2:	length								
Octet 3:	10010001								
Octet 4:	10000100								
INDEX NUMBER	<p>This Parameter comprises a sequence of up to Three IA5 numeric characters representing a message index number between 0 and 255 (decimal).</p>								

3 CODING OF SUPPLEMENTARY INFORMATION STRING PARAMETERS

PARAMETER NAME	DESCRIPTION AND CODING
INTRUSION CAPABILITY LEVEL	<p>The Intrusion Capability level comprises a single IA5 numeric character 0, 1, 2 or 3:</p> <p>example: *21*1#</p> <p>Executive Intrusion Request with ICL = 1</p>
INTRUSION PROTECTION LEVEL	<p>The Intrusion Protection Level comprises a single IA5 numeric character 0, 1, 2, or 3:</p> <p>example: *23*2#</p> <p>IPL = 2</p>
ISDN NUMBER ATTRIBUTES	<p>This Parameter comprises a sequence of IA5 characters representing the value of octet group 3 (ie octet 3, or octets 3 and 3a, etc) of an ISDN Calling Party Number or Connected Number information element, using 3B4I encoding (see Subsection 5 of this Annex).</p> <p>The example of encoding the ISDN NUMBER DIGITS Parameter includes an example of how to encode this Parameter.</p>
ISDN NUMBER DIGITS	<p>This Parameter comprises a sequence of IA5 numeric characters representing the number digit octets (octet 4, and any repetitions) of an ISDN Calling Party Number or Connected Number information element. The most significant (spare) bit of each number digit octet is deleted and the remaining seven bit codes are the IA5 numeric character codes of TABLE 1 of DPNSS[188], SECTION 4, ANNEX 4.</p> <p>The following example shows the encoding of both an ISDN NUMBER ATTRIBUTES and an ISDN NUMBER DIGITS Parameter as contained in an ISDN Calling Party Number information element:</p> <pre> Octet 1: identifier Octet 2: length Octet 3: 11001001 1st Octet 4: 00110010 2nd Octet 4: 00110101 3rd Octet 4: 00111001 4th Octet 4: 00110101 </pre> <p>would be encoded as: *235*rP*2595#</p>

3 CODING OF SUPPLEMENTARY INFORMATION STRING PARAMETERS

PARAMETER NAME	DESCRIPTION AND CODING
ISDN NUMBER DIGITS (Continued)	This Parameter is optional; omission of the Parameter indicates that octet 4 is not present in the corresponding ISDN information element.
ISDN SUBADDRESS	<p>This Parameter comprises a sequence of IA5 characters representing the values of octets 3, onwards of an ISDN Called Party Subaddress, Calling Party Subaddress or Connected Subaddress information element, using 3B4I encoding (see Subsection 5 of this Annex).</p> <p>example: The following Calling Party Subaddress information element:</p> <p style="padding-left: 40px;">Octet 1: identifier Octet 2: length Octet 3: 10000000 Octet 4: 01010000 Octet 5: 01000001 Octet 6: 01000010</p> <p>would be encoded as: *236A*`EAAP`#</p>
ISDN TYPE	<p>This Parameter represents the type of public ISDN interface encountered.</p> <p>It comprises a single IA5 character as follows:</p> <p style="padding-left: 40px;">A = ETS 300 102 B = DASS 2</p> <p>Further types may be added in later issues of DPNSS[188], DPNSS[189] and DPNSS[189-I].</p> <p>This Parameter is optional. If not present then this shall be taken to indicate that no specific information about the type of ISDN interface is available. A PBX may, where necessary, make assumptions about the signalling type when this Parameter is not present.</p>
LOCATION	<p>The location of the failure is identified by using an IA5 character allocated as follows:</p> <p>T = Other terminal P = Call Path E = Equipment needed to make the connection I = Incompatible due to clash of services</p> <p>If more than one is applicable, the one appearing first in the above list shall be used.</p>

3 CODING OF SUPPLEMENTARY INFORMATION STRING PARAMETERS

PARAMETER NAME	DESCRIPTION AND CODING
<p>LOW LAYER COMPATIBILITY</p>	<p>This Parameter comprises a sequence of IA5 characters representing the values of octets 3, onwards of an ISDN Low Layer Compatibility information element, using 3B4I encoding (see Subsection 5 of this Annex).</p> <p>example: The following Low Layer Compatibility information element:</p> <pre> Octet 1: identifier Octet 2: length Octet 3: 10001000 Octet 4: 10010000 Octet 5: 00100001 Octet 5a: 01000101 Octet 5b: 00100000 Octet 5c: 10110011 </pre> <p>would be encoded as: *239*bI@aQRBs#</p>
<p>MALICIOUS CALL REFERENCE</p>	<p>This Parameter is an IA5 numeric character sequence comprising up to 3 digits for identifying a request to trace a malicious call a DPNSS 1 network.</p> <p>This Parameter is optional. It may be omitted if Malicious Call References are not used.</p>
<p>NESTING LEVEL</p>	<p>This Parameter is used to indicate the number of hunt groups that the call has passed through. It comprises a single IA5 numeric character in the range 1-9 to represent the level of nesting.</p> <p>This Parameter is optional; omission of the Parameter indicates a nesting level of 1.</p>
<p>NIGHT SERVICE ADDRESS</p>	<p>The Night Service Address is that digit sequence which, when used as a Destination Address, will cause a call to be routed to the Night Service point. This Parameter comprises a sequence of IA5 numeric characters each in the range 0 - 9, sent most significant first.</p> <p>example: *128A*3678# (Night Service - Divert to address 3678)</p> <p>This Parameter is optional. It may be omitted if no address is available.</p>

3 CODING OF SUPPLEMENTARY INFORMATION STRING PARAMETERS

PARAMETER NAME	DESCRIPTION AND CODING
NSI IDENTIFIER	<p>This Parameter consists of two IA5 characters indicating a manufacturer and a manufacturer specific code.</p> <p>The first character is as allocated in TABLE 1 of SECTION 15 of DPNSS[188]. The second character may be any IA5 character legal for use in a Supplementary Information String Parameter.</p>
NUMBER OF CALLS	<p>This indicates the number of unanswered calls currently waiting on an extension number, or the position of a call currently queued.</p> <p>The Parameter comprises a decimal number coded as up to two IA5 numeric characters.</p>
NUMBER OF FURTHER ALTERNATIVE ROUTES	<p>This Parameter is optional. If included it specifies the number of further alternative routes allowed during routing of the call. It comprises a single IA5 alpha character in the range A-Z; A representing 0 and Z representing 25.</p>
NUMBER OF FURTHER TRANSITS	<p>This Parameter is the count of the number of further Transit PBXs allowed to route the call it comprises a single IA5 alpha character in the range A-Z; A representing 0 and Z representing 25.</p>
NUMBER OF SERVERS	<p>The Number of Servers Parameter indicates the number of positions capable of answering the queued calls.</p> <p>The Parameter comprises a decimal number coded as up to two IA5 numeric characters.</p>
PASSWORD	<p>This Parameter comprises up to 12 IA5 alphanumeric characters which may be used as a password.</p> <p>When used with Travelling Class of Service Request (TCOS-R) this Parameter is optional.</p>
PBX FLAG	<p>This Parameter is optional. If included it contains the single IA5 character "S" to indicate that the address contained in the previous Parameter is on the same PBX as the sender of the message.</p>

3 CODING OF SUPPLEMENTARY INFORMATION STRING PARAMETERS

PARAMETER NAME	DESCRIPTION AND CODING
PBX REFERENCE NUMBER	<p>This is the sequence of IA5 numeric characters used to identify the PBX sending the TID String.</p> <p>When used as the Destination Address it will cause routing to the sending PBX.</p>
PICK-UP CALL TYPE	<p>The Pick-Up Call Type Parameter gives the type of Pick-Up required. It comprises a single IA5 character allocated as follows:</p> <p>R = Ringing call H = Held call W = Waiting call P = Parked call</p> <p>More than one Type may be included in the Parameter, each being separated by the IA5 character space (2/0). Where more than one Type is included, PBX-T shall assign its own priority.</p> <p>This Parameter is optional and if omitted then PBX-T shall assign its own Type and priority</p>
PRIORITY LEVEL	<p>This Parameter comprises a sequence of up to three IA5 numeric characters representing a priority level between 0 and 255 (decimal).</p>
PROGRESS INDICATOR	<p>This Parameter comprises a sequence of IA5 characters representing the values of octets 3, onwards of an ISDN Progress Indicator information element, using 3B4I encoding (see Subsection 5 of this Annex).</p> <p>example: The following Progress Indicator information element:</p> <p>Octet 1: identifier Octet 2: length Octet 3: 10000010 Octet 4: 10000010</p> <p>would be encoded as: *240*`hH#</p>

3 CODING OF SUPPLEMENTARY INFORMATION STRING PARAMETERS

PARAMETER NAME	DESCRIPTION AND CODING
REASON FOR REDIRECTING	<p>This Parameter consists of two IA5 characters. The first character defines the state of the call before redirection:-</p> <p>A = Awaiting answer H = Held W = Waiting on busy</p> <p>The second character indicates whether the call was transferred into that state:-</p> <p>E = Transferred by an extension N = Not transferred O = Transferred by an operator R = Transferred by the party to whom the call is being redirected</p>
RECONNECT ADDRESS	<p>That digit sequence which, when used as a Destination Address, will cause a call to be routed to the party to whom reconnection is required.</p> <p>This Parameter comprises a sequence of IA5 numeric characters, each in the range 0-9. The numbers are sent most significant first.</p> <p>example: *124B*123456# Reconnect a caller who has requested Series Call Supplementary Service to address 123456.</p>
REMOTE ADDRESS	<p>This Parameter comprises a sequence of IA5 numeric characters representing the digits output by a Gateway PBX to another signalling system.</p>
RESTRICTION DOMAIN	<p>This Parameter indicates the domain in which number presentation restriction applies and comprises a single IA5 numeric character allocated as follows:</p> <p>1 = Private 2 = Public</p> <p>Further values may be added in future issues of DPNSS[188], DPNSS[189] and DPNSS[189-I]</p> <p>Where more than one restriction applies they shall each be included in the Parameter, separated by the IA5 character, space (2/0).</p> <p>This Parameter is optional; its omission indicates total restriction.</p>

3 CODING OF SUPPLEMENTARY INFORMATION STRING PARAMETERS

PARAMETER NAME	DESCRIPTION AND CODING
RESTRICTION INDICATOR	<p>This parameter indicates the domain in which number presentation restriction applies and comprises a single IA5 numeric character allocated as follows:</p> <p>0 = No restriction 1 = Restricted in all domains 2 = Restricted in the private domain only 3 = Restricted in the public domain only</p>
ROUTE RESTRICTION CLASS	<p>The Route Restriction Class Parameter indicates the routing entitlements of the party.</p> <p>It comprises a decimal number (from 0 upwards), coded as one or more IA5 numeric characters, or the null value which is the IA5 character, hyphen (2/13).</p>
ROUTING INFORMATION	<p>Routing Information comprises a single IA5 numeric character allocated as follows:</p> <p>1 = Alternative Route 2 = Spare</p> <p>3 = Public ISDN encountered (see NOTE 1)</p> <p>4 = PSTN encountered 5 = Decadic encountered (see NOTE 2)</p> <p>6 = MF5 encountered 7 = Private ISDN encountered</p> <p style="text-align: right;">] These values are used when interworking with other signalling systems - see DPNSS[189] and DPNSS[189-I]</p> <p>NOTE 1: In earlier issues of DPNSS[188] and DPNSS[189] Parameter value 3 indicated DASS 2 encountered. The scope of this value has since been expanded to cover access to the public ISDN in general.</p> <p>NOTE 2: In earlier issues of DPNSS[188] and DPNSS[189] Parameter value 5 indicated 10 pps encountered. The scope of this value has since been expanded to cover access to non-DPNSS 1 private circuits in general.</p>

3 CODING OF SUPPLEMENTARY INFORMATION STRING PARAMETERS

PARAMETER NAME	DESCRIPTION AND CODING
ROUTING INFORMATION (CONTINUED)	<p>Further Routing Information codes may be added in later issues of DPNSS[188], DPNSS[189] and DPNSS[189-I].</p> <p>More than one routing information digit can be included in the Parameter each being separated by the IA5 character space (2/0).</p> <p>example: *51*1 4#</p> <p>alternative route taken via the PSTN.</p> <p>Where the same value occurs more than once it shall be treated by the receiving PBX as if the value appeared only once.</p> <p>Values that are not recognised may be ignored and the String processed on the remainder of the Parameter values. Transit PBXs shall pass on the complete Parameter, including the unrecognised values. If none of the values in the Parameter is recognised, the String shall be treated as if the Parameter were missing.</p>
SERVICE MARKING	<p>The Service Marking Parameter supplements the Calling or Called Line Category. It comprises a single IA5 character allocated as follows:</p> <ul style="list-style-type: none">1 = PSTN BARRED2 = EMERGENCY TELEPHONE3 = HUNT GROUP4 = DISTRIBUTED GROUP5 = UNABLE TO INITIATE CLEARING AFTER ANSWER (Note)6 = RING GROUP <p>Further Service Marking Codes may be added in later issues of DPNSS[188], DPNSS[189] and DPNSS[189-I].</p> <p>The term "hunt group" refers to a group of destinations where, when a call is routed to the group, the PBX decides according to a pre-defined algorithm to whom the call should be presented. The term "ring group" refers to a group of destinations where, when a call is routed to the group, the PBX presents the call to all group members simultaneously.</p>

3 CODING OF SUPPLEMENTARY INFORMATION STRING PARAMETERS

PARAMETER NAME	DESCRIPTION AND CODING
SERVICE MARKING (CONTINUED)	<p>More than one Service Marking character can be included in the Parameter, each being separated by the IA5 character space (2/0).</p> <p>With the exception of code 6 (ring group), if one (or more) of the allocated codes is (are) not present in this Parameter then the receiving PBX shall presume the negation of the associated attribute(s).</p> <p>example: *1*2 3#</p> <p>= CLC-ORD: <u>NOT</u> PSTN BARRED, EMERGENCY TELEPHONE, HUNT GROUP, <u>NOT</u> DISTRIBUTED GROUP, <u>ABLE</u> TO INITIATE CLEARING AFTER ANSWER.</p> <p>If no Parameter value is to be included then the Supplementary String Identifier shall be followed by a # and all the associated attributes shall be presumed by the receiving PBX to be negated.</p> <p>example: *1#</p> <p>= CLC-ORD: <u>NOT</u> PSTN BARRED, <u>NOT</u> EMERGENCY TELEPHONE, <u>NOT</u> HUNT GROUP, <u>NOT</u> DISTRIBUTED GROUP, <u>ABLE</u> TO INITIATE CLEARING AFTER ANSWER</p> <p>Where the same value occurs more than once, it shall be treated by the receiving PBX as if the value appeared only once.</p> <p>Values that are not recognised may be ignored and the String processed on the remainder of the Parameter values. Transit PBXs shall pass on the complete Parameter including the unrecognised values. If none of the values in the Parameter is recognised, the String shall be treated as if the Parameter were missing.</p> <p>Note: The value 5 of this Parameter gives no indication of the ability (or inability) to initiate clearing <u>before</u> answer.</p>

3 CODING OF SUPPLEMENTARY INFORMATION STRING PARAMETERS

PARAMETER NAME	DESCRIPTION AND CODING
SERVICES	<p>The SERVICES Parameter is a single IA5 character allocated as follows:</p> <ul style="list-style-type: none">1 = Call Offer not possible2 = Executive Intrusion not possible3 = Call Back When Free not possible4 = Call Back Messaging <u>not</u> possible (see Note)5 = Hold not possible6 = Call Back When Next Used not possible <p>Note: In DPNSS[188], Issue 4, this value of the Parameter represented "Call Back Messaging possible". This has been changed here to harmonise with the other attributes of the Parameter which are all negative.</p> <p>Further values may be added in later issues of DPNSS[188], DPNSS[189] and DPNSS[189-I].</p> <p>More than one character may be included in the Parameter, each being separated by the IA5 character space (2/0).</p> <p>If one (or more) of the allocated codes is (are) not provided for this Parameter then the receiving PBX shall <u>not</u> presume that the associated Supplementary Service(s) is (are) available.</p> <p>example: *166*1 3#</p> <p>Service information indicating that neither Call Offer nor Call Back When Free are possible. Other Supplementary Services may be possible</p> <p>If the same value occurs more than once it shall be treated by the receiving PBX as if the value appeared only once.</p> <p>Values that are not recognised may be ignored and the String processed on the remainder of the Parameter values. Transit PBXs shall pass on the complete Parameter including the unrecognised values. If none of the values in the Parameter is recognised, the String shall be ignored.</p>

3 CODING OF SUPPLEMENTARY INFORMATION STRING PARAMETERS

PARAMETER NAME	DESCRIPTION AND CODING
SIC	<p>This Parameter comprises a sequence of IA5 characters representing the value of the SIC octet(s), using 1B2I encoding (see Subsection 5 of this Annex).</p> <p>example: BSS-M; 48 kbit/s data; X30 Synchronous, full duplex, byte timed, X25 packet, clock locked to transmission. (ie SIC Octets: 10100010, 00110100).</p> <p>would be encoded as: *47R*JB CD#</p> <p>This Parameter may be used to carry either a DPNSS 1 SIC in association with a SIC String, or a DASS 2 SIC in association with a D-SIC String.</p> <p>It should be noted that, whilst DPNSS 1 SICs are a maximum of 2 octets in length, DASS 2 SICs may be extended in future issues of BTNR 190 to more than 2 octets.</p>
STAFF PRESENT	<p>This indicates whether maintenance staff are on site. If so, no action need be taken if alarms are being raised.</p> <p>It comprises a single IA5 character, used as follows:</p> <p>Y = Staff are on site. N = No staff are on site.</p> <p>This Parameter is optional.</p> <p>If the Parameter is omitted it shall be assumed that no staff are present.</p>
STATE OF DESTINATION	<p>This Parameter indicates the State of destination of the called party and is used as an adjunct to a Supplementary Information String used in a Clear Request Message.</p> <p>It comprises a single IA5 character allocated as follows:</p> <p>B = Busy F = Free</p>

3 CODING OF SUPPLEMENTARY INFORMATION STRING PARAMETERS

PARAMETER NAME	DESCRIPTION AND CODING
STATE OF DESTINATION QUALIFIER	<p>This Parameter indicates that the value of the accompanying State Of Destination Parameter is assumed.</p> <p>It comprises a single IA5 numeric character allocated as follows:</p> <p>A = Assumed</p> <p>This Parameter is optional.</p> <p>This Parameter is used when the PBX generating the State Of Destination Parameter value is only able to provide an assumed value (eg when interworking with another signalling system).</p>
STATE OF OPERATOR	<p>This Parameter consists of a single IA5 alpha character allocated as follows:</p> <p>N = The Operator group or specific position has night mode activated.</p> <p>D = The Operator group or specific position has night mode deactivated (day mode).</p>
STATUS	<p>The Status Parameter supplements the Calling Line Categories: DEC, ISDN, PSTN and MF5. It comprises a single IA5 character allocated as follows:</p> <p>1 = Non-DDI 2 = No Release Signal at any point in the call 3 = Release only available after Answer 4 = Outgoing 5 = Null</p> <p>Further Status codes may be added in later issues of DPNSS[188], DPNSS[189] and DPNSS[189-I].</p> <p>More than one Status Character can be included in the Parameter, each being separated by the IA5 character, space (2/0).</p>

3 CODING OF SUPPLEMENTARY INFORMATION STRING PARAMETERS

PARAMETER NAME	DESCRIPTION AND CODING
STATUS (CONTINUED)	<p>If one (or more) of the codes 1 - 4 is (are) not present in this Parameter then the receiving PBX shall presume the negation of the associated attribute(s) as in the following examples:</p> <p>*2*1# = CLC-DEC: Non-DDI, (Can release at any time), (Incoming).</p> <p>*2*3 4# = CLC-DEC: (DDI), Can release only after Answer, Outgoing.</p> <p>*4*2 4# = CLC-PSTN: (DDI), Can never release, Outgoing.</p> <p>Note: Deduced values are shown in brackets ().</p> <p>The Parameter value 5 shall be used when no other Parameter value is to be included and it is required to add a second Parameter to the String, eg "ISDN TYPE" in the case of CLC-ISDN.</p> <p>If no Parameter value 1 - 4 is to be included and no second Parameter is to be added, then the Supplementary String Identifier shall be followed by #.</p> <p>examples:</p> <p>*3# = CLC-ISDN: no Parameter value 1 - 4 and no "ISDN Type" Parameter present.</p> <p>*3*5*B# = CLC-ISDN: no Parameter value 1 - 4 and ISDN Interface explicitly identified as DASS 2.</p> <p>*3*2 4*A# = CLC-ISDN: Parameter values 2 and 4 are applicable and ISDN Interface explicitly identified as ETS 300-102.</p> <p>Where the same value occurs more than once, it shall be treated by the receiving PBX as if the value appeared only once.</p> <p>Where the values 2 and 3 appear together, the value 3 shall be ignored.</p>

3 CODING OF SUPPLEMENTARY INFORMATION STRING PARAMETERS

PARAMETER NAME	DESCRIPTION AND CODING
STATUS (CONTINUED)	<p>The values 1 and 4 should not be considered contradictory, as the value 1 refers to the DDI characteristics of the trunk whenever it is used incoming, whereas the value 4 refers to the direction of use of the trunk on the current call.</p> <p>For the purposes of supplying and interpreting the value 3, Answer should be considered as the sending or receiving of a valid CCM irrespective of whether it contains the String SIM-A. A trunk should be considered able to Release only if a Release signal is guaranteed by a normal event (eg a timeout or user action). If Release is possible (eg via a maintenance action) but not guaranteed under normal operation, the trunk should be considered as unable to Release.</p> <p>Once a particular trunk has been allocated its STATUS Parameter(s) for a given call, that allocation shall remain fixed for the duration of that call.</p> <p>Values that are not recognised may be ignored and the String processed on the remainder of the Parameter values. Transit PBXs shall pass on the complete Parameter including the unrecognised values. If none of the values in the Parameter is recognised, the String shall be treated as if the Parameter were missing.</p>
STRING ID	<p>The Parameter String ID comprises a copy of the IA5 numerals and suffix letter of one Supplementary Information String Identifier.</p> <p>example: *95*27#</p> <p>The Call Offer Service is unavailable at the called extension.</p> <p>In the case of NSI Strings, however, it is necessary to allow for the first Parameter of the NSI String to be included as part of the Parameter "String ID". In this case the NSI Parameter is separated from the ID (58) and Suffix by a semicolon.</p> <p>example: *95*58B;AA# (String 58B*AA rejected because service is unavailable)</p>

3 CODING OF SUPPLEMENTARY INFORMATION STRING PARAMETERS

PARAMETER NAME	DESCRIPTION AND CODING
STRING ID LIST	<p>String ID List comprises a copy of the IA5 numerals and suffix letter of one or more Supplementary Information String Identifiers. Where more than one is included they shall be separated by a space (2/0).</p> <p>example *98*48I 49I#</p> <p>The requests for Bearer Service Selection (Preferred) and Bearer Service Selection (Notification) were not understood, and were ignored.</p> <p>In the case of NSI Strings, however, it is necessary to allow for the first Parameter of the NSI String to be included as part of the Parameter "String ID List". In this case the NSI Parameter is separated from the ID (58) and Suffix by a semicolon.</p> <p>example: *98*58A;AB 58A;AC# (Strings 58A*AB and 58A*AC ignored not understood)</p>
SUBADDRESS	<p>This Parameter comprises either a sequence of IA5 numeric characters (maximum 40) or a sequence of IA5 characters representing a sequence of binary octets (maximum 20) using 1B2I encoding (see Subsection 5 of this Annex).</p>
TEST INDEX	<p>This Parameter indicates the test to be performed on the associated traffic channel. It is coded as a sequence of IA5 numeric characters, the significance of which is a matter for negotiation between the suppliers of the PBXs connected via the traffic channels.</p> <p>This Parameter is optional and may be omitted if the default test for the traffic channel is to be used.</p>
TEST RESULT	<p>This Parameter indicates the result of a test by means of a single IA5 numeric character allocated as follows:</p> <p>0 = Pass 1 = Fail 2 = Aborted</p>

3 CODING OF SUPPLEMENTARY INFORMATION STRING PARAMETERS

PARAMETER NAME	DESCRIPTION AND CODING
TEXT	This Parameter is used to indicate the textual information required for display. It may be up to 24 IA5 characters, with the * represented by TC1 (0/1) and the # represented by TC2 (0/2).
TEXT TYPE	<p>This Parameter is optional and defines the type of text provided in the String. It comprises a single IA5 character allocated as follows:</p> <ul style="list-style-type: none">1 = Name2 = Message3 = Reason for call failure <p>Further TEXT TYPE values may be added in later issues of DPNSS[188], DPNSS[189] and DPNSS[189-I].</p> <p>If the Parameter is not present no meaning may be assumed.</p> <p>Values which are not recognised may be ignored, the String being treated as if the Parameter were missing.</p>
TIME AND DATE	<p>This comprises six Parameters which are structured as follows:</p> <ul style="list-style-type: none">Parameter 1: Year (4 IA5 numeric characters)Parameter 2: Month (2 IA5 numeric characters in the range 01 to 12).Parameter 3: Day of the month (2 IA5 numeric characters in the range 01 to 31).Parameter 4: Hour of the day (2 IA5 numeric characters in the range 00 to 23).Parameter 5: Minute of the hour (2 IA5 numeric characters in the range 00 to 59).Parameter 6: Second (2 IA5 numeric character in the range 00 to 59). <p>These six Parameters must always be sent as a block and in the above order:</p> <p>example: *164B*1994*10*21*15*35*11#</p> <p>The time and date is 3.35 and 11 seconds pm, 21 October 1994</p>

3 CODING OF SUPPLEMENTARY INFORMATION STRING PARAMETERS

PARAMETER NAME	DESCRIPTION AND CODING
TIME INTERVAL	<p>This Parameter comprises a sequence of IA5 Numeric characters or a sequence of IA5 numeric characters followed by another IA5 character Sequence consisting of the IA5 character "dot" (2/14) and a sequence of IA5 numeric characters. This Parameter represents a time interval in seconds to N decimal places where N is the number of numeric characters in the second sequence (N=0 if the second sequence is not present).</p> <p>When used with Call Pick-Up Strings PU-DVG and PU-DVT this Parameter is optional. Its omission indicates that no Time Interval value is available.</p>
TIMER VALUE	<p>This Parameter is optional. It comprises a sequence of IA5 numeric characters representing a timer value as an integer number of seconds.</p>
TRUNK GROUP REFERENCE NUMBER	<p>This is the sequence of IA5 numeric characters used to identify a Trunk Group at a particular PBX.</p>
TRUNK MEMBER REFERENCE NUMBER	<p>This is the sequence of IA5 numeric characters used to identify a Trunk Member within a Trunk Group at a particular PBX.</p>
TYPE OF ASSISTANCE	<p>This Parameter comprises a single IA5 alpha character followed by a single IA5 numeric character. The alpha character defines the assistance type as follows:</p> <p>E = A call from outside the private Network seeking assistance for the first time.</p> <p>I = A call from within the private network seeking assistance for the first time.</p> <p>R = A call already handled by an operator seeking assistance again.</p> <p>The numeric character comprises a number between 0 and 9 and offers the possibility to differentiate priority within a given assistance type. The higher the number the higher the priority.</p>

3 CODING OF SUPPLEMENTARY INFORMATION STRING PARAMETERS

PARAMETER NAME	DESCRIPTION AND CODING
UNITS	This Parameter comprises a sequence of IA5 numeric characters representing a number of charge units as a decimal number.
VPN ACCESS REFERENCE NUMBER	This is a sequence of IA5 numeric characters Used to identify the path of entry to a VPN.

4 EXPLANATION OF STRING IDENTIFIERS

Mnemonic (Code)	String Description (First Used in Section)
A10 (145)	SSMF5 Signal "A-10" (6/189) This String is used when a call which comes from SSMF5 has been routed via DPNSS 1 and has encountered an outgoing SSMF5 route which is capable of working in SSMF5 Early Enhanced Code, and has information to send.
A12 (149)	SSMF5 Signal "A-12" (6/189) This String is used when a call which comes from SSMF5 has been routed via DPNSS 1 and has encountered an outgoing SSMF5 route which is capable of working in SSMF5 Early Enhanced Code, but has no information to send.
A13 (147)	SSMF5 Signal "A-13" (6/189) This String is used when a call which comes from SSMF5 has been routed via DPNSS 1 and has encountered an outgoing SSMF5 route and subsequently the PSTN.
A14 (148)	SSMF5 Signal "A-14" (6/189) This String is used when a call which comes from SSMF5 has been routed via DPNSS 1 and has encountered an outgoing SSMF5 route, and a Tandem PBX on that route is requesting the next routing digit.
A2 (140)	SSMF5 Signal "A-2" (6/189) This String is used when a call which comes from SSMF5 has been routed via DPNSS 1 and has encountered an outgoing SSMF5 route, and a Tandem PBX on that route has requested all the routing digits to be sent to it.
A5 (142)	SSMF5 Signal "A-5" (6/189) This String is used when a call which comes from SSMF5 has been routed via DPNSS 1 and has encountered an outgoing SSMF5 route, and a PBX on that route has requested the Calling Party Category.

4 EXPLANATION OF STRING IDENTIFIERS

Mnemonic (Code)	String Description (First Used in Section)
A7 (150)	SSMF5 Signal "A-7" (6/189) This String is used when a call which comes from SSMF5 has been routed via DPNSS 1 and has encountered an outgoing SSMF5 route which requests the use of a Manufacturer Specific User Code within SSMF5, and indicates that the address is complete.
A8 (144)	SSMF5 Signal "A-8" (6/189) This String is used when a call which comes from SSMF5 has been routed via DPNSS 1 and has encountered an outgoing SSMF5 route, and a Tandem PBX on that route is Alternatively Routing the call and requests that all the routing digits are sent to it.
AC-CBI (181)	Add-On Conference - Conference Bridge Identity (29) Used to convey the address of a conference bridge or group.
AC-CDC (176B)	Add-On Conference - Clear Down Conference (29) Used as request from controlling party of a conference to clear down the whole conference.
AC-DR (179B)	Add-On Conference - Details Request (29) Used by any party of a conference to request details of the other conference parties.
AC-NAO (170)	Add-On Conference - No Add-On Currently Available (29) Used by Conference PBX to indicate that it is temporarily unable to accept Add-on request.
AC-PD (180)	Add-On Conference - Party Details (29) This String and other Strings in the message contain details of a conference party.
AC-PI (177)	Add-On Conference - Party Index (13) This String is used to identify a conference party in the order of that party's addition to the conference.

4 EXPLANATION OF STRING IDENTIFIERS

Mnemonic (Code)	String Description (First Used in Section)
ACK (55)	Acknowledge (10) The String is used to inform the Originating PBX that the request it has made has been accepted.
ACT (102B)	Activate (27) The String is used to instruct the recipient PBX to activate the maintenance state referred to in the maintenance action.
AD-O (90)	Added-On (13) The String is used to inform a PBX that its party is now involved in a conference.
AD-RQ (88H)	Add-On Request (13) The String is used when the controlling party in a 3-Party Service requests that all 3 parties are connected together to form a conference.
AD-V (89B)	Add-On Validation (13) This String is sent to a party's PBX to determine whether the party is allowed to be connected in conference and to obtain details of the party.
ARC (211)	Auxiliary Route Restriction Class (16) This String is used to enable an extension user to activate a limited number of barring levels in addition to those set in the Route Restriction Class Parameter of the Class of Service (COS) String.
AS (161B)	Alarm Status (28) This String indicates the current alarm status of the sending PBX.
AS-R (162B)	Alarm Status Request (28) This String is used to request the current alarm status of a PBX.
ASST-INFO (205)	Assistance Information (16) This String is used to indicate the type and level of assistance that is required on a call.

4 EXPLANATION OF STRING IDENTIFIERS

Mnemonic (Code)	String Description (First Used in Section)
AUTO-A (199)	Autoanswer (16) This String indicates that answer has been generated By terminal equipment rather than by user action.
BAS (92)	Basic (6/189) This String indicates that the SSMF5 route involved in the call is capable only of Basic Working.
BSS-M (47R)	Bearer Service Selection - Mandatory (18) This String is used to ensure that the selected bearer will be able to cope with an anticipated transmission capacity which could be different from that specified in the SIC. If there are no channels available which are compatible with both BSS-M and the SIC, then clear down or rejection will occur.
BSS-N (49I)	Bearer Service Selection - Notification (18) This String is used to notify Transit PBXs that the originating terminal has the ability to swap to a service requiring a different transmission capacity but has not indicated any intention of swapping. Transit PBXs need not make a special attempt to Satisfy the service indicated in the BSS-N String, but if the channel provided is not suitable for the service in the BSS-N String, then the Originating PBX should be notified.
BSS-P (48I)	Bearer Service Selection - Preferred (18) This String is used when a call will probably require a change of service. Preference should be given to bearers satisfying the service in the BSS-P String as well as the service in the SIC, but if only the service in the SIC can be satisfied, the call shall proceed and the Originating PBX shall be notified.
BY-INFO	This String has been renamed Service Information (SERV)
CAUSE (231)	Cause (6) This String is used to convey a Clearing Cause value.

4 EXPLANATION OF STRING IDENTIFIERS

Mnemonic (Code)	String Description (First Used in Section)
CBC (15B)	Call Back Complete (9) This String indicates that the signalling related to the CBWF service has been completed and the call can be handled as a Simple Call.
CBM-C (172B)	Call Back Messaging - Cancel (36) This String is used to cancel the Call Back Message at the Terminating PBX.
CBM-CSU (245)	Call Back Messaging - Call Set Up (36) This String is used to indicate that a call set up is a call resulting from a Call Back Messaging - Request.
CBM-R (171B)	Call Back Messaging - Request (36) This String is used to register the Call Back Message at the Terminating PBX.
CBWF-C (13B)	Call Back When Free - Cancel (9) This String is used when a calling party requests the cancellation of a CBWF. It is also used when a CBWF is cancelled as a result of a time out expiring.
CBWF-CB (156B)	Call Back When Free - Call Back Request (9/189) This String is used when a call coming from SSMF5 makes a Call Back Request (ie not Free Notification as normal in DPNSS 1).
CBWF-CLB (151B)	Call Back When Free - Call Back Call (9/189) This String is used in an ISRM to indicate that the B party is free and that the call being established is a Call Back Call which is in response to an SSMF5 Call Back When Free - Call Back (this is not the same as CBWF-CSUD/I).
CBWF-CSUD (16B)	Call Back When Free - Call Set-Up (Delayed) (9) This String is used in an ISRM to indicate that the call being established is a call back call that has been delayed, eg because the A party was busy when the Free Notification was received.

4 EXPLANATION OF STRING IDENTIFIERS

Mnemonic (Code)	String Description (First Used in Section)
CBWF-CSUI (12B)	Call Back When Free - Call Set-Up (Immediate) (9) This String is used in an ISRM to indicate that the call being established is a call back call that has been made immediately following receipt of a Free Notification.
CBWF-FN (11B)	Call Back When Free - Free Notification (9) This String is used in a call to notify the Originating PBX that the called extension is now free.
CBWF-R (10B)	Call Back When Free - Request (9) This String is used to register a CBWF - Request at the Terminating PBX.
CBWNU-R (17B)	Call Back When Next Used - Request (31) This String is used to register a Call Back When Next Used Request at the Terminating PBX.
CD-CSU (97B)	Call Distribution - Call Set Up (43) This String is used to indicate that the call being Set up is a Call Distribution call resulting from a Call Distribution - Free Notify.
CD-DNQ (67B)	Call Distribution - Do Not Queue (43) This String is used to indicate to an Answer Point PBX that it should not queue the call if the required Answer Point is busy.
CD-FN (86B)	Call Distribution - Free Notify (43) This String is used to notify a Distributor PBX that an Answer point is available to take a call.
CD-LINK (69B)	Call Distribution - Linked (43) This String is used to inform an Answer Point that a call has been linked into a queue at a Distributor PBX
CD-Q (63)	Call Distribution - Queue (43) This String is used to inform an Answer Point PBX that it may queue a call if the required Answer Point is busy.

4 EXPLANATION OF STRING IDENTIFIERS

Mnemonic (Code)	String Description (First Used in Section)
CD-UNLINK (93B)	Call Distribution - Unlinked (43) This String is used to inform an Answer Point that a call is no longer linked into the queue at a Distributor PBX.
CDIV (119)	Controlled Diversion (21) This String indicates that Controlled Diversion is required; any Diversion encountered should be reported back to the Originating PBX.
CH-AC (182)	Charge Reporting-Account Code (40) This String conveys the account code associated with the charged party.
CH-ACR (183B)	Charge Reporting-Account Code Request (40) This String is used to request that an account code be sent.
CH-ACT (184)	Charge Reporting-Active (40) This String indicates that charging data may be available from the Terminating PBX.
CH-CLR (185B)	Charge Reporting-Clear (40) This String is used to request termination of the call but retention of the path so that cost data can be returned.
CH-CR (186B)	Charge Reporting-Cost Request (40) This String is used to request the cost of a call so far.
CH-CST (187)	Charge Reporting-Cost (40) This String conveys the monetary cost of the call.
CH-TR (188)	Charge Reporting-Time Rate (40) This String conveys the monetary cost incurred, for a given time interval, by the current call.

4 EXPLANATION OF STRING IDENTIFIERS

Mnemonic (Code)	String Description (First Used in Section)
CH-UR (189)	Charge Reporting-Unit Rate (40) This String conveys the monetary cost per charge unit.
CH-UU (190)	Charge Reporting-Units Used (40) This String conveys the cost of the call in charge units.
CHID (105B)	Channel Identity (27) This String is used to indicate the identity of a channel. It is used where another channel (in addition to the one identified at Level 2) is involved in a transaction.
CLC-CONF (NOTE 1)	This String has been withdrawn; see NOTE 1 below.
CLC-DASS2	This String has been renamed CLC-ISDN and its application has been extended.
CLC-DEC (2)	Calling/Called Line Category - Decadic (6/189) This String is used to inform the recipient PBX that the calling or called party is via a non-DPNSS 1 private circuit (eg 10 pps Decadic).
CLC-ISDN (3) (NOTE 2)	Calling/Called Line Category - ISDN (6/189-I) This String is used to inform the recipient PBX that the calling or called party is via an ISDN or ISDN like access to the public network

NOTE 1: In DPNSS[189], DPNSS[189-I] and earlier issues of DPNSS[188], IDENTIFIER CODE No 8 was allocated to CLC-CONF (Calling Line Category - Conference). No Supplementary Service has ever been written incorporating this String; to avoid confusion this String has been withdrawn and IDENTIFIER CODE No 8 is now undefined.

NOTE 2: In DPNSS[189] and earlier issues of DPNSS[188], IDENTIFIER CODE No 3 was allocated to CLC-DASS2. The scope of this CLC has since been expanded to cover access to the public ISDN in general and the CLC has consequently been renamed as CLC-ISDN.

4 EXPLANATION OF STRING IDENTIFIERS

Mnemonic (Code)	String Description (First Used in Section)
CLC-MF5 (5)	<p>Calling/Called Line Category - SSMF5 (6/189)</p> <p>This String is used to inform the recipient PBX that the calling or called party is via an SSMF5 route.</p>
CLC-NET (7)	<p>Calling/Called Line Category - Network (9)</p> <p>This String is used to inform the recipient PBX that this call is a network call with no calling/called party.</p>
CLC-OP (6)	<p>Calling/Called Line Category Operator (20)</p> <p>This String is used to inform the recipient PBX that the calling or called party is an Operator in the private network.</p>
CLC-ORD (1)	<p>Calling/Called Line Category - Ordinary (6)</p> <p>This String is used to inform the recipient PBX that the calling or called party is an extension in the private network.</p>
CLC-PSTN (4)	<p>Calling/Called Line Category - PSTN (6/189)</p> <p>This String is used to inform the recipient PBX that the calling or called party is on the Public Switched Telephone Network.</p>
CLI (50)	<p>Called Line Identity (6)</p> <p>See under OLI</p>
CO (27)	<p>Call Offer (14)</p> <p>This String is used when a calling party wishes to wait on a busy called extension and give a Call Waiting indication to the wanted party.</p>
COC (84H)	<p>Connected Call (13)</p> <p>This String is used to differentiate between two calls when signalling is via a shared channel. The String is passed between the Branching PBX and the Originating PBX to indicate that the message relates to the Connected call and not the held call.</p>

4 EXPLANATION OF STRING IDENTIFIERS

Mnemonic (Code)	String Description (First Used in Section)
COS (18)	Class Of Service (16) This String is used to convey the Class Of Service of a party.
CP (232)	Call Proceeding (6/189-I) This String is used to convey the fact that no further routing information is required.
CW (26)	Call Waiting (17) This String is used when a call is accepted for a party who is busy on another call.
D-SIC (57A)	DASS 2 - Service Indicator Code (16/189) This String is used to convey a DASS 2 Service Indicator Code in a DPNSS 1 message. To enable further DASS 2 SICs to be added in later issues of BTNR 190 the Parameter of this String is not checked or acted upon within the DPNSS 1 network but is carried transparently between End PBXs. All Parameter values are considered to be valid and are passed on to the Extension Process or DASS 2 Signalling System Process.
DEACT (103B)	Deactivate (27) This String is used to instruct the recipient to deactivate the maintenance state referred to in the Maintenance Action.
DI (109)	Device Identity (43) This String is used to further sub-divide a DA, OLI or CLI in order to identify uniquely a particular device. Diversion - Bypass (11)
DIV-BY (32)	This String is used to override any Diversion (Immediate, On Busy or On No Reply) encountered at the Terminating PBX.

4 EXPLANATION OF STRING IDENTIFIERS

Mnemonic (Code)	String Description (First Used in Section)
DIV-CA (36B)	<p>Diversion - Cancel All (11)</p> <p>This String is used to instruct the recipient PBX to remove any type of Diversion from the extension indicated by the DA to the destination identified in the OLI.</p>
DIV-CB (35B) -CI (33B) -CR (34B)	<p>Diversion - Cancel On Busy (11)</p> <p>- Cancel Immediate (11)</p> <p>- Cancel On No Reply (11)</p> <p>These Strings are similar to DIV-CA except that only the type of diversion specified is cancelled.</p>
DIV-FM (31B)	<p>Diversion - Follow me (11)</p> <p>When an extension has Diversion Immediate registered, this String may be sent from the nominated extension's PBX to request that the nominated extension for Diversion Immediate be changed.</p>
DIV-RCA (76B)	<p>Diversion - Remote Cancel All (33)</p> <p>This String indicates that an extension or operator is requesting cancellation of all types of Diversion.</p>
DIV-RCB (74B)	<p>Diversion - Remote Cancel Busy (33)</p> <p>This String indicates that an extension or operator is requesting cancellation of Diversion On Busy.</p>
DIV-RCC (229B)	<p>Diversion - Remote Cancel Combined (33)</p> <p>This String indicates that an extension or operator is requesting cancellation of Combined Diversion.</p>
DIV-RCI (73B)	<p>Diversion - Remote Cancel Immediate (33)</p> <p>This String indicates that an extension or operator is requesting cancellation of Diversion Immediate.</p>
DIV-RCR (75B)	<p>Diversion - Remote Cancel No Reply (33)</p> <p>This String indicates that an extension or operator is requesting cancellation of Diversion On No Reply.</p>

4 EXPLANATION OF STRING IDENTIFIERS

Mnemonic (Code)	String Description (First Used in Section)
DIV-RSB (71B)	<p>Diversion - Remote Set Busy (33)</p> <p>This String indicates that an extension or operator is requesting registration of Diversion On Busy.</p>
DIV-RSC (228B)	<p>This String indicates that an extension or operator is requesting registration of Combined Diversion.</p>
DIV-RSI (70B)	<p>Diversion - Remote Set Immediate (33)</p> <p>This String indicates that an extension or operator is requesting registration of Diversion Immediate.</p>
DIV-RSR (72B)	<p>Diversion - Remote Set No Reply (33)</p> <p>This String indicates that an extension or operator is requesting registration of Diversion On No Reply.</p>
DIV-V (30B)	<p>Diversion Validation (11)</p> <p>This String is used in a Virtual Call to validate that the nominated extension can receive diverted calls.</p>
DND (113)	<p>Do Not Disturb (32)</p> <p>This String is used in conjunction with:</p> <ul style="list-style-type: none"> - Clearing Cause: BY, to indicate that the DND condition exists. - String RCF, to indicate that the reason for redirection is because the DND condition has been encountered.
DND-C (116B)	<p>Do Not Disturb-Clear (34)</p> <p>This String indicates that the destination extension's DND condition is to be removed.</p>
DND-O (114)	<p>Do Not Disturb-Override (32)</p> <p>This String is used to override any DND condition encountered at the Terminating PBX.</p>
DND-S (115B)	<p>Do Not Disturb-Set (34)</p> <p>This String indicates that the DND condition is to be invoked at the destination extension.</p>

4 EXPLANATION OF STRING IDENTIFIERS

Mnemonic (Code)	String Description (First Used in Section)
DPU-R (216B)	<p>Directed Pick-Up - Request (46)</p> <p>This String is sent from the service-requesting PBX to the Target extension's PBX when the service requester invokes the Directed Call Pick-Up facility.</p>
DRS (160)	<p>Direct Route Select (16)</p> <p>This String is used in an ISRM or RM to indicate that a call is not to use alternative routes.</p> <p>Where the destination is outside the DPNSS 1 network the Destination Address may imply a particular route. The use of String DRS ensures that the implied route is used, even though it may not be the first-choice Route to the destination.</p>
DVD-B (43)	<p>Diverted - On Busy (11)</p> <p>This String is used to inform the Originating PBX that the call has been diverted on busy to an another extension on the same PBX.</p>
DVD-E (53)	<p>Diverted - Externally (11/189)</p> <p>This String is used to inform the Originating PBX that the call has been diverted out of the DPNSS 1 network via another signalling system.</p>
DVD-I (42)	<p>Diverted - Immediate (11)</p> <p>This String is used to inform the Originating PBX that the call has been diverted immediately to another extension on the same PBX.</p>
DVD-R (44)	<p>Diverted On No Reply (11)</p> <p>This String is used to inform the Originating PBX that the call has been diverted on no reply to another extension on the same PBX.</p>
DVG (154)	<p>Diverting (11/189)</p> <p>This String is used in the establishment of a call from the Originating PBX to the nominated extension, to indicate that the call has been diverted from a signalling path that cannot indicate the type of diversion, eg SSMF5.</p>

4 EXPLANATION OF STRING IDENTIFIERS

Mnemonic (Code)	String Description (First Used in Section)
DVG-B (38F) -I (37F) -R (39F)	<p>Diverting - On Busy (11)</p> <p>- Immediate (11)</p> <p>- On No Reply (11)</p>
	<p>These Strings are used in the establishment of a call from the Originating PBX to the divert nominated extension, to indicate that the call has been diverted.</p>
DVL (248)	<p>Diversion - Last Controlling Extension Identity (11)</p>
	<p>This String is used to convey the last type of diversion and the identity and presentation restriction attribute of the last controlling extension in a chain of diversions.</p>
DVT (152B)	<p>Divert (11/189)</p>
	<p>This String is used to inform the Originating PBX that Diversion has been encountered on an SSMF5 route and that the call should be diverted to the address given in the Parameter.</p>
DVT-B (41B)	<p>Divert on Busy (11)</p>
	<p>This String is used to inform the Originating PBX that Divert On Busy has been encountered and the call should be diverted to the address given as a Parameter.</p>
DVT-CF (204)	<p>Divert on Call Failure (22)</p>
	<p>This String is used to inform the Originating PBX that the current call has failed and should be directed to the address given in the Parameter.</p>
DVT-I (40B)	<p>Divert Immediate (11)</p>
	<p>This String is used to inform the Originating PBX that Diversion Immediate has been encountered and the call should be diverted to the address given as a Parameter.</p>

4 EXPLANATION OF STRING IDENTIFIERS

Mnemonic (Code)	String Description (First Used in Section)
DVT-R (45)	<p>Divert - On No Reply (11)</p> <p>This String is used to inform the Originating PBX that the no-reply time-out has matured and the call should be diverted to the address given as a Parameter.</p>
DVT-RD (203)	<p>Divert - Redirection (22)</p> <p>This String is used to inform the Originating PBX that the current call is subject to Redirection and should be diverted to the address given in the second Parameter. The first Parameter gives the reason for redirection.</p>
EI-C (24B)	<p>Executive Intrusion - Convert (14)</p> <p>This String is used when a calling party wishes to intrude on the wanted party of the Call Offer or the Call Waiting Service. The String includes as a Parameter the Intrusion Capability Level (ICL) of the calling party.</p>
EI-I (25)	<p>Executive Intrusion - Intruded (10)</p> <p>This String is used to inform the Originating PBX that intrusion has occurred.</p>
EI-PVR (20)	<p>Executive Intrusion - Prior Validation Request (10)</p> <p>If this String is included in a call request which encounters a busy extension, the Terminating PBX checks whether intrusion is permitted and if so, notifies the Originating PBX and retains the call, awaiting instructions to proceed with the intrusion.</p>
EI-R (21)	<p>Executive Intrusion - Request (10)</p> <p>This String is used when a calling party wishes to intrude on a wanted party who is on an established connection. The String includes as a Parameter the Intrusion Capability Level (ICL) of the calling party.</p>
EI-W (202B)	<p>Executive Intrusion - Withdraw (10)</p> <p>This String is used to indicate that the intruding party wishes to withdraw from the three way call but wishes to maintain the call to allow subsequent reconnection to the wanted party.</p>

4 EXPLANATION OF STRING IDENTIFIERS

Mnemonic (Code)	String Description (First Used in Section)
ENH (91B)	Enhanced SSMF5 (6/189) This String is used to indicate that the SSMF5 route encountered is capable of Enhanced working.
ENQ (80)	Enquiry Call (13) This String is used to indicate that the call being established is an Enquiry Call. The String Parameter gives the Called/Calling Line Category of the held party.
ERD (194)	External Rerouting Disabled (16) This String indicates that no attempt should be made to alternatively reroute the call, neither via another signalling system, nor by establishing a new DPNSS 1 call with a different Destination Address.
EST (118B)	Extension-Status Call (20) This String indicates that the call being established is an Extension-Status Call.
FR-R (106B)	Forced Release - Request (38) This String is used to indicate that a party which has intruded on an established call is requesting the release of the unwanted party.
GPU-R (213B)	Group Pick-Up - Request (46) This String is sent from the service-requesting PBX to the Target PBXs when the service requester invokes the Group Call Pick-Up facility.
HDG (62)	Holding (5, ANNEX 4) This String is used to indicate to a PBX that a party is holding the call. This enables holding indication to be applied, if required. This String is used only in situations where the party is already holding the call but a Supplementary Service Facility (eg Transfer) makes it necessary to inform another PBX.

4 EXPLANATION OF STRING IDENTIFIERS

Mnemonic (Code)	String Description (First Used in Section)
HF-A (200)	Hands Free - Activated (16) This String indicates hands free operation (loudspeech) is activated at the associated terminal.
HF-D (201)	Hands Free - Deactivated (16) This String indicates hands free operation (loudspeech) is deactivated at the associated terminal.
HGF (29)	Hunt Group Forwarded (16) A call's Destination Address may be the address of a hunt group. If the hunt group extends over more than one PBX, the call may be forwarded over a DPNSS 1 route. The String HGF is included in the ISRM or RM to indicate to the Terminating PBX that the call has been forwarded from a hunt group.
HOLD-REQ (60B)	Hold - Request (12) This String is used when either party of a call in the conversation state, requests hold.
I-BC (233) NOTE)	ISDN - Bearer Capability (6/189-I) This String is used to convey ISDN Bearer Capability.
I-CC (234)	ISDN - Clearing Cause (6/189-I) This String is used to convey an ISDN Cause.
I-CPN (235)	ISDN - Calling Party/Connected Number (6/189-I) This String is used to convey either an ISDN Calling Party Number or an ISDN Connected Number.
I-CSA (236A)	ISDN - Calling Party/Connected Subaddress (6/189-I) This String is used to convey either an ISDN Calling Party Subaddress or an ISDN Connected Subaddress.

NOTE: This String Identifier Code shall have no suffix or a "B" suffix depending on the outcome of attempting to generate a SIC from Bearer Capability and/or Low Layer Compatibility(see DPNSS[189-I] SECTION 4, ANNEX 2 and SECTION 6).

4 EXPLANATION OF STRING IDENTIFIERS

Mnemonic (Code)	String Description (First Used in Section)
I-DSA (237A)	ISDN - Destination Subaddress (6/189-I) This String is used to convey an ISDN Called Party Subaddress.
I-HLC (238)	ISDN - High Layer Compatibility (6/189-I) This String is used to convey ISDN High Layer Compatibility.
I-LLC (239 NOTE)	ISDN - Low Layer Compatibility (6/189-I) This String is used to convey ISDN Low Layer Compatibility.
I-PROG (240)	ISDN - Progress (6/189-I) This String is used to convey ISDN Progress Indicators. More than one Progress Indicator may be included in the same String by repeating the Parameter.
ICC (87)	Intercom Call (16) This String indicates that the call is between two closely associated extensions, enabling the Terminating PBX to take certain special actions. The actions taken are PBX dependent, see SECTION 16 of DPNSS[188].
IG-SNU (98)	Ignored - Signal Not Understood (5) This String is used if one or more unrecognised Strings with an optional suffix are received in a message. The IG-SNU Parameter identifies the String ignored.
IG-SU (99)	Ignored - Service Unavailable (18) This String is used if the service requested is supported but not available. The IG-SU Parameter identifies the String ignored.

NOTE: This String Identifier Code shall have no suffix or a "B" suffix depending on the outcome of attempting to generate a SIC from Bearer Capability and/or Low Layer Compatibility (see DPNSS[189-I] SECTION 4, ANNEX 2 and SECTION 6).

4 EXPLANATION OF STRING IDENTIFIERS

Mnemonic (Code)	String Description (First Used in Section)
INT-A (246A)	Interim Answer (16) This String is used in a CCM to cause the receiving PBX to generate an answer signal to the calling party prior to the called party answering, but to continue to await a further CCM to indicate actual answer by the called party.
IPL (23)	Intrusion Protection Level (10) This String is used to inform another PBX of a party's Intrusion Protection Level.
IPL-R (22B)	Intrusion Protection Level - Request (10) This String is used to request the Intrusion Protection Level (IPL) of a party in an established call.
IPN (241)	Interworking Via a Private ISDN (6/189-I) This String is used to indicate that the call is Routed via a private network employing ISDN-type signalling.
IRD (193)	Internal Rerouting Disabled (16) This String indicates that no attempt should be made To alternatively reroute the call via DPNSS 1 using The same Destination Address.
LA (19)	Loop Avoidance (37) This String is used to convey the number of further Transit PBXs through which a call may be routed and, optionally, the number of further alternative routes which may be taken.
M-INDEX (244)	Message Index (16) This String is used to convey the index number of a predefined message (eg text, announcement, etc).

4 EXPLANATION OF STRING IDENTIFIERS

Mnemonic (Code)	String Description (First Used in Section)
MCI (222K)	<p>Malicious Call Indication (16)</p> <p>This String is used to indicate that a call is malicious and that identification and registration of its source is requested. It may be included in an EEM or an LLM, sent after answer.</p>
NAE-CC (173)	<p>Network Address Extension - Calling/Called Identity Complete (16)</p> <p>This String conveys the whole or final part of an originating/terminating subaddress.</p>
NAE-CI (174)	<p>Network Address Extension - Calling/Called Identity Incomplete (16)</p> <p>This String conveys the first part of an originating/terminating subaddress.</p>
NAE-DC (157)	<p>Network Address Extension - Destination Complete (41)</p> <p>This String conveys the whole or final part of a destination subaddress.</p>
NAE-DI (159)	<p>Network Address Extension - Destination Incomplete (41)</p> <p>This String conveys the first part of a destination subaddress.</p>
NLT-PT (195B)	<p>Non-Looped Back Test - Perform Test (27)</p> <p>This String is used to request that a sequence of test patterns be transmitted on a traffic channel.</p>
NLT-RES (198B)	<p>Non-Looped Back Test - Test Result (27)</p> <p>This String indicates the result of the verification procedure applied to a received test pattern.</p>
NLT-RQ (196B)	<p>Non-Looped Back Test - Test Request (27)</p> <p>This String indicates that the sequence of test patterns being received on the traffic channel should be verified for correct receipt.</p>

4 EXPLANATION OF STRING IDENTIFIERS

Mnemonic (Code)	String Description (First Used in Section)
NLT-SC (197B)	<p>Non-Looped Back Test - Sequence Complete (27)</p> <p>This String indicates that a transmitted test pattern sequence is complete.</p>
NPR-A (209) (NOTE)	<p>Number Presentation Restriction - A Party (48)</p> <p>This String is used in an ISRM, RM, ERM or SSRM to indicate that the address conveyed by the OLI in the same Selection Block is presentation restricted.</p> <p>The Parameter indicates to which numbering domain or domains the restriction applies.</p>
NPR-B (210) (NOTE)	<p>Number Presentation Restriction - B Party (48)</p> <p>This String is used in any message other than an ISRM, RM, ERM or SSRM to indicate that the address conveyed by the CLI in the same Indication Block is presentation restricted.</p> <p>Where a NAM, or a CRM sent in response to an ISRM, RM or ERM, is sent without a CLI (eg a NAM or a CRM containing DVT-I) then NPR-B may be included to indicate that the address conveyed by the received Destination Address digits is presentation restricted.</p> <p>The Parameter indicates to which numbering domain or domains the restriction applies.</p>
NPR-O (221) (NOTE)	<p>Number Presentation Restriction - Other Party (48)</p> <p>This String is used in any message to indicate that the address conveyed by any String in the same Selection or Indication Block, other than OLI or CLI, is presentation restricted.</p> <p>The Parameter indicates to which numbering domain or domains the restriction applies.</p>

NOTE: The NPR-A, NPR-B and NPR-O String Identifier Codes shall have no Suffix, an "A" Suffix or a "B" Suffix depending on the requirements of a network with respect to how PBXs that do not recognise NPR-A, NPR-B or NPR-O should be forced to respond to their receipt.

4 EXPLANATION OF STRING IDENTIFIERS

Mnemonic (Code)	String Description (First Used in Section)
NS-DA (134)	Night Service - Deactivation (25) This String is sent from an Operator PBX to an Originating PBX to indicate that the operator group or specific position, which was previously in Night Mode, has returned to normal.
NS-DVD (130)	Night Service - Diverted (25) This String indicates that the call has been diverted to a Night Service Point on the same PBX. The Parameter contains the address of the Night Service Point.
NS-DVG (129)	Night Service - Diverting (25) This String indicates that the call being established has been diverted having encountered an operator group or specific position in Night Mode. This String is always accompanied by String DVG-R, which conveys the address of the operator group or position.
NS-DVT (128A)	Night Service - Divert (25) This String indicates to an Originating PBX that the called operator group or specific position is in Night Mode and diversion to a Night Service Point is recommended. If the Operator PBX is able to supply the address of a Night Service Point it is given as a Parameter.
NS-N (127B)	Night Service - Notification (25) This String indicates that the operator group or specific operator position indicated by String OLI has changed from normal mode to Night Mode or vice versa, as indicated by the Parameter.
NS-RDVD (133)	Night Service - Rediverted (25) This String indicates that the call has been rediverted from a Night Service Point to the original operator group or specific position on the same PBX. The Parameter contains the address of the operator.

4 EXPLANATION OF STRING IDENTIFIERS

Mnemonic (Code)	String Description (First Used in Section)
NS-RDVG (132)	Night Service - Rediverting (25) This String indicates that the call being established has been rediverted from a Night Service Point to the originally called operator group or specific position. This String is always accompanied by String DVG-R, which conveys the address of the Night Service Point.
NS-RDVT (131)	Night Service - Redivert (25) This String is sent from a Night Service Point PBX to an Originating PBX when the operator group or specific position, from which the call was originally diverted because of Night Mode, is known to be available again. The Originating PBX is invited to redivert the call to the operator, whose address is given as a Parameter.
NSI (58) (NOTE)	Non-Specified Information (15) This String is used to convey network or manufacturer dependent information between PBXs.
NSL (223)	Network Signalling Limit (16) This String may be included in a CRM containing Clearing Cause: Network Termination (NT). Its inclusion indicates that the call has exceeded signalling limits imposed by the node of the network that has cleared the call.
OCP (59)	Originally Called Party (5, ANNEX 4) This String is used to convey the identity of the originally called party when a transfer occurs before answer, following diversion.
OLI/CLI (50)	Originating Line Identity/Called Line Identity (6) This String is used to inform the recipient PBX of the Calling (OLI)/Called (CLI) Line Identity. The String Parameter contains the A/B Party Address of the Calling/Called party.

NOTE: The Suffix of the NSI String Identifier depends on the Parameter contents.

4 EXPLANATION OF STRING IDENTIFIERS

Mnemonic (Code)	String Description (First Used in Section)
OPD (191)	Output Digits (40/189) This String conveys the digits sent to another signalling system.
OPD-R (192B)	Output Digits - Request (40/189) This String is used to request the Gateway to send the digits sent to another signalling system.
PARK (168B)	Park Request (42) This String is used when a calling party wishes to be parked on another extension.
PASSW (77B)	Password (16) This String conveys a password, used in conjunction with a Supplementary Service. It is used by the receiving End PBX to verify that the other party has the necessary authority.
PB-P (107J)	Priority Breakdown Protection (35) This String conveys the protection level that is to be associated with a call against Priority Breakdown.
PB-R (108)	Priority Breakdown Request (35) This String indicates a request to break down an existing call.
PCLG-D (252)	Public Calling Party Number - Default(16) This String is used to indicate that a default calling party number should be provided to the called party if a call is routed into the public network.
PCLG-P (251)	Public Calling Party Number - Provided (16) This String is used to convey the calling party number that should be provided to the called party if a call is routed into the public network.

4 EXPLANATION OF STRING IDENTIFIERS

Mnemonic (Code)	String Description (First Used in Section)
PCON-D (254)	Public Connected Number - Default (16) This String is used to indicate that a default connected number should be provided to the calling party if a call is received from the public network.
PCON-P (253)	Public Connected Number - Provided (16) This String is used to convey the connected number that should be provided to the calling party if a call is received from the public network.
PKD (169)	Parked (42) This String indicates that the current call is parked at an extension on another PBX.
PU-DVD (220)	Call Pick-Up - Diverted (46) This String is sent from a combined service-requesting and Target PBX to the Originating PBX when the Call Pick-Up has been completed.
PU-DVG (215B)	Call Pick-Up - Diverting (46) This String indicates that the call being established has been diverted to an extension diverted as a result of a Pick-Up Request from that extension. The String is always accompanied by String DVG-R which conveys the address of the extension from which the call has been picked up.
PU-DVT (214B)	Call Pick-Up - Divert (46) This String is sent from the Target extension's PBX to the other PBX in the call that is being picked-up, inviting that PBX to divert the call to the address given in the Parameter.
Q-INFO (135)	Queue Information (16) This String is used to indicate the number of unanswered calls currently waiting on an extension number and the number of positions capable of answering it. If the String is used within a call currently queued, that call shall be included, otherwise it shall not be included.

4 EXPLANATION OF STRING IDENTIFIERS

Mnemonic (Code)	String Description (First Used in Section)
PU-DVG (215B)	Call Pick-Up - Diverting (46) This String indicates that the call being established has been diverted to an extension diverted as a result of a Pick-Up Request from that extension. The String is always accompanied by String DVG-R which conveys the address of the extension from which the call has been picked up.
PU-DVT (214B)	Call Pick-Up - Divert (46) This String is sent from the Target extension's PBX to the other PBX in the call that is being picked-up, inviting that PBX to divert the call to the address given in the Parameter.
Q-INFO (135)	Queue Information (16) This String is used to indicate the number of unanswered calls currently waiting on an extension number and the number of positions capable of answering it. If the String is used within a call currently queued, that call shall be included, otherwise it shall not be included.
Q-PRIO (136)	Queueing Priority (16) This String conveys the priority of a call which may be used where a call is queued to determine the appropriate place in the queue for the call.
RCC-CA (217)	Route Capacity Control - Capacity Available (44) This String is used in a CRM in conjunction with Clearing Cause: Congestion to indicate that the route capacity that is allocated for the call is fully occupied, however, alternative channels on the route are still available to those extensions that are allowed to override the allocated capacity.

4 EXPLANATION OF STRING IDENTIFIERS

Mnemonic (Code)	String Description (First Used in Section)
RCC-OI (219)	<p>Route Capacity Control - Override Invoked (44)</p> <p>This String is used in either an ISRM or a NIM.</p> <p>When used in an ISRM this String indicates that the call has overridden route capacity control limits and is allowed to do so again if further route capacity control limits are encountered.</p> <p>When used in a NIM this String notifies the Originating PBX that route capacity congestion has been encountered and overridden.</p>
RCF (121)	<p>Redirecting on Call Failure (22)</p> <p>This String indicates that the call being established has been redirected owing to call failure. The Parameters contain the original Destination Address and the Clearing/Rejection Cause.</p>
RDC (230)	<p>Redirection Control (16)</p> <p>This String is used either to inform an Originating PBX of the timer value to run before invoking Redirection, or to request that redirection not be invoked at all.</p>
RDG (120)	<p>Redirecting (22)</p> <p>This String indicates that the call being established has been Redirected on a timeout expiry whilst awaiting connection or reconnection. The Parameters contain information about the history of the call. This String is always accompanied by String DVG-R, which conveys the address of the extension from which the call has been redirected.</p>
RECON (61)	<p>Reconnected (12)</p> <p>This String is used when a user who previously put a call on hold has reconnected.</p>
RED-BY (206)	<p>Redirection - Bypass (22)</p> <p>This String is used to instruct the Originating PBX not to invoke the Redirection Service.</p>

4 EXPLANATION OF STRING IDENTIFIERS

Mnemonic (Code)	String Description (First Used in Section)
REJ (54)	Reject (12) This String is used to inform a PBX that a particular Supplementary Service request has been rejected.
RO (14B)	Ring Out (9) This String is used to instruct the Terminating PBX to ring the called extension.
ROP-CON (112B)	Route Optimisation - Connected (19) This String indicates that the new (optimised) path is being used and the original path can be cleared.
ROP-CSU (111H)	Route Optimisation - Call Set Up (19) This String indicates that the call being established is a Route Optimisation call.
ROP-INV (249)	Route Optimise Invite (16) This String is used to indicate that the sending PBX wishes route optimisation to take place, in the case where it does not need to know if the request is going to be acted on.
ROP-INVA (250A)	Route Optimise Invite with Acknowledgement (19) This String is used to indicate that the sending PBX wishes route optimisation to take place, in the case where it needs to know if the request is going to be acted on.
ROP-R (110B)	Route Optimisation - Request (19) This String invites the Receiving PBX to attempt the establishment of a new path back to the Sending PBX via the optimum route, with a view to allowing the call to use that path instead of the existing path. The Parameter is the Destination Address to be used.

4 EXPLANATION OF STRING IDENTIFIERS

Mnemonic (Code)	String Description (First Used in Section)
RR-SNU (96)	Recall Rejected - Signal Not Understood (5) This String is used to inform the Originating PBX, which has requested recall, that Single Channel Working is not supported for the requested service. The String Parameter identifies the rejected String.
RTI (51)	Routing Information (6) This String is used to inform the Originating PBX of any notable details of the route taken on a call. The String Parameter indicates alternative route used or Gateway encountered.
SATB (165)	Satellite Barred (16) This indicates that a satellite route is not to be selected. It is used typically where a call has already been routed across one satellite link, but may also be used to avoid satellite links altogether.
SAVE (242)	Save (6/189-I) This String is used to indicate that the Strings conveyed in the message in which SAVE is received are to be saved and processed along with the contents of a subsequent message. SAVE may only be used as described in DPNSS[189-I], SECTION 5, Subsection 3.5 .
SCE (81F)	Single Channel Enquiry (13) This String is used when an Enquiry Call is established using the same channel as the held call. The String Parameter gives the Held Party's category.
SER-C (125)	Series Call - Cancel (23) This String is used to cancel a Series Call Request.
SER-E (126)	Series Call - Establishment (23) This String indicates that the call being established is a Series Call.

4 EXPLANATION OF STRING IDENTIFIERS

Mnemonic (Code)	String Description (First Used in Section)
SER-R (124B)	Series Call - Request (23) This String is used to register a Series Call Request. The parameter contains the Destination Address to be used when the Series Call is subsequently established.
SERV (166) (Formerly, BY-INFO)	Service Information (16) This String is used to provide additional information to indicate which Supplementary Services may be used later in a call. Its use is designed to reduce the number of attempts to use Supplementary Services which will then fail. It may also be used for display purposes.
SFI (158)	Supplementary Facilities Inhibited (16) This String instructs recipient PBXs not to attempt any Supplementary Services during the call.
SHTL (83F)	Shuttle (13) This String is used to inform the Branching PBX that the controlling party in a three-party service requests Shuttle.
SIC (46)	Service Indicator Code (7/189) This String is used to convey a DPNSS 1 Service Indicator Code in message types which do not normally convey an SIC.
SIM-A (101)	Simulated Answer (6/189) This String is used on calls to the PSTN where it is not known whether an Answer signal will be provided.
SN (56)	Send Next (6/189) This String is used to indicate that a DPNSS 1 PBX which has received a call from SSMF5 has insufficient routing digits and requires the next address digit from SSMF5.

4 EXPLANATION OF STRING IDENTIFIERS

Mnemonic (Code)	String Description (First Used in Section)
SN-REQ (28T)	Send Next Request (6/189) This String is used to indicate that the call is coming from an SSMF5 route that requires any Transit or Terminating PBX to return a NIM containing Send Next(SN) and that any DPNSS 1 Terminating PBX should send the IPL of the called party if it is free. This String should also be used to withhold ringing at a Terminating PBX when received in an ISRM.
SNU (94)	Signal Not Understood (5) This String is used to inform a PBX that the contents of a message it sent have not been understood. The String Parameter indicates the reason for not understanding the message contents, eg a String which was not understood.
SOD-B (65)	State of Destination - Busy (9) The String is used in certain situations to inform a PBX that the other party is busy.
SOD-F (66)	State of Destination - Free (9) The String is used in certain situations to inform a PBX that the other party is free.
SOD-I (153)	State of Destination Indeterminable (11/189) This String is used when a Gateway PBX has received a signal B-14 from SSMF5 indicating that the called extension on the SSMF5 route is on diversion.
SOD-REQ (155B)	State of Destination Request (11/189) This String is used when a call from SSMF5 requests Diversion Bypass on a diverting call. It is used to request the SOD of the diverting party if the Bypass is allowed.

4 EXPLANATION OF STRING IDENTIFIERS

Mnemonic (Code)	String Description (First Used in Section)
SPL (78B)	Split (13) This String is used to inform the Conference PBX that the controlling party in an Add-On Conference requests Split. If the String is accompanied by the String AC-PI, connection shall be made to the party indicated, otherwise connection shall be to the party who was connected before Add-On, the other party being placed on hold.
SU (95)	Service Unavailable (5) This String is used to inform the requesting party that the service it has requested is supported but not available on this extension. The String Parameter contains the Identifier of the String which was used to request the service.
SW-R (138)	Swap Rejected (8) This String indicates that the swap of service cannot be carried out. The Parameter indicates the reason why the attempt failed.
SW-V (137T)	Swap Validation (8) This String requests a check to be carried out to ensure that the service can be changed.
TAD (164B)	Time and Date (30) This String conveys the current time and date and enables the receiving PBX to adjust its clock accordingly.
TAD-R (163B)	Time and Date - Request (30) This String is used to request the time and date from a Terminating PBX.
TCOS (226)	Travelling Class of Service (47) This String is sent from a PBX to indicate a Travelling Class of Service.

4 EXPLANATION OF STRING IDENTIFIERS

Mnemonic (Code)	String Description (First Used in Section)
TCOS-R (227B)	<p>Travelling Class of Service - Request (47)</p> <p>This String is sent from the Originating PBX to the Terminating PBX to request a Travelling Class of Service. This String may also contain a password as a Parameter.</p>
TCS (104B)	<p>Traffic-Channel Status (27)</p> <p>This String is used to inform the recipient of the current status of the channel. It identifies whether or not it may be used for traffic and also whether or not it is in use.</p>
TEXT (100)	<p>Textual Display (16)</p> <p>This String contains textual display information.</p>
TEXTM (64B)	<p>Text Message (39)</p> <p>This String conveys a text message for display at the receiving extension. Confirmation is required that the message has been accepted.</p>
TID (167)	<p>Trunk Identity (16)</p> <p>This String is used in conjunction with a CLC to identify a trunk: either a channel at a Gateway between DPNSS 1 and another signalling system, or a traffic channel within the DPNSS 1 network.</p>
TOV-R (122H)	<p>Takeover Request (24)</p> <p>The currently connected Non-Controlling Party's PBX in a Three-Party situation sends this String to the Branching PBX in order to request to become the controlling party.</p>
TOV-V (123B)	<p>Takeover - Validation (24)</p> <p>This String indicates to the Controlling PBX in a Three-Party situation that takeover has been requested. The Controlling PBX must check whether takeover is permissible and reply to the Branching PBX.</p>

4 EXPLANATION OF STRING IDENTIFIERS

Mnemonic (Code)	String Description (First Used in Section)
TRFD (82)	Transferred (13) This String is used to inform the recipient PBX that the controlling party in a Three Party Service has transferred the call. The String Parameter is used to nominate one of the remaining parties as the originating and the other as the terminating party.
TRFR (85)	Transfer Request (13) This String instructs a Branching PBX in the Three-Party Service to transfer together the other two parties.
TWP (79)	Two Party (13) This String is used to inform a PBX that its party is no longer involved in a conference. The String Parameter is used to nominate one of the remaining parties as the originating and the other as the terminating party.
V-NID (243)	VPN - Nodal Identity (16) This String is used in a Virtual Private Network (VPN) to identify the PBX in a DPNSS 1 network which interfaces with the VPN. The PBX identified by this String will be at the originating end of a VPN connection being set up between two otherwise isolated parts of a private network.
VIC (208)	VPN Initiated Clear (16) This String is used in conjunction with a public network supported Virtual Private Network service to indicate that call clearing has been initiated by the public network equipment.
WOB (212)	Wait On Busy (45) This String is used when a calling party wishes to on a busy called extension without giving Call Waiting Indication to the wanted party.

5 SUPPLEMENTARY INFORMATION STRING PARAMETERS: BINARY OCTET ENCODING DETAILS

5.1 INTRODUCTION

Subsection 3 lists the Parameters to the Supplementary Information Strings of Subsection 2 in alphabetical order.

Within DPNSS 1 a Parameter is defined as a restricted IA5 character sequence. Each Parameter definition in Subsection 3 describes how IA5 characters represent the Parameter values and gives the meaning of each value.

Certain Parameters (eg SIC) are required to convey the values of a number of binary octets where all 8 bits of each octet are significant; such octets cannot be represented directly by IA5 characters since these use only 7 bits of each octet. A means of encoding using more than one IA5 character per octet is defined in paragraph 5.2.

5.2 BINARY OCTET ENCODING

Two methods of encoding binary octets into IA5 characters are used for Parameters in this specification. Where one binary octet is encoded into two IA5 characters; this is termed, "1B2I octet encoding". Where three binary octets are encoded into four IA5 characters; this is termed, "3B4I octet encoding". These methods are described in paragraphs 2.1 and 2.2, respectively.

Which of these methods is to be used for a particular Parameter is specified along with the Parameter in Subsection 3.

5.2.1 1B2I Octet Encoding

In 1B2I octet encoding, each binary octet is divided into blocks of 4 bits. Each 4 bit block is represented by the corresponding IA5 character shown in TABLE 1.

The IA5 characters are sent in order, starting with the character representing the most significant block of the first octet.

On receipt of this Parameter the Terminating PBX discards bits 5 to 7 of each IA5 character in the Parameter Field and then concatenates the remaining 4 bits of each pair of characters to reassemble the original binary octets.

TABLE 1: 4 BIT BLOCK CODING

4 BIT BLOCK MSB LSB	IA5 CHARACTER
0 0 0 0	@
0 0 0 1	A
0 0 1 0	B
0 0 1 1	C
0 1 0 0	D
0 1 0 1	E
0 1 1 0	F
0 1 1 1	G
1 0 0 0	H
1 0 0 1	I
1 0 1 0	J
1 0 1 1	K
1 1 0 0	L
1 1 0 1	M
1 1 1 0	N
1 1 1 1	O

NOTE: TABLE 1 is a subset of the DPNSS 1 Character Coding Table (DPNSS[188], SECTION 4, ANNEX 4, TABLE 1).

The codes for the IA5 characters assigned as a result of the 1B2I encoding process can be derived from the corresponding 4 bit block by the addition of "100" in the bit positions 7, 6, 5, respectively. For example, 4 bit block "0101" is assigned IA5 character "E" and the IA5 code for character "E" is "1000101".

Example of 1B2I encoding:

the octets 10100010
 00110100 would be encoded as: JBCD in IA5

5.2.2 3B4I Octet Encoding

In 3B4I octet encoding, binary octets are grouped together in threes and then the resulting 24 bit block is split into four 6 bit blocks; each 6 bit block shall be assigned an IA5 character in accordance with TABLE 2.

Where the number of binary octets to be encoded is not a multiple of three, or is less than three, there will be either one or two octets remaining to be encoded.

In the case when one octet remains, four zero bits shall be added to it after the least significant bit, to make two 6 bit blocks; each 6 bit block shall be assigned an IA5 character in accordance with TABLE 2.

In the case where two octets remain, two zero bits shall be added after the least significant bit of the last octet to make three 6 bit blocks; each 6 bit block shall be assigned an IA5 character in accordance with TABLE 2.

TABLE 2: 6 BIT BLOCK CODING

6 BIT BLOCK						IA5
MSB					LSB	CHARACTER
0	0	0	0	0	0	@
0	0	0	0	0	1	A
0	0	0	0	1	0	B
0	0	0	0	1	1	C
0	0	0	1	0	0	D
0	0	0	1	0	1	E
0	0	0	1	1	0	F
0	0	0	1	1	1	G
0	0	1	0	0	0	H
0	0	1	0	0	1	I
0	0	1	0	1	0	J
0	0	1	0	1	1	K
0	0	1	1	0	0	L
0	0	1	1	0	1	M
0	0	1	1	1	0	N
0	0	1	1	1	1	O
0	1	0	0	0	0	P
0	1	0	0	0	1	Q
0	1	0	0	1	0	R
0	1	0	0	1	1	S
0	1	0	1	0	0	T
0	1	0	1	0	1	U
0	1	0	1	1	0	V
0	1	0	1	1	1	W
0	1	1	0	0	0	X
0	1	1	0	0	1	Y
0	1	1	0	1	0	Z
0	1	1	0	1	1	[
0	1	1	1	0	0	\
0	1	1	1	0	1]
0	1	1	1	1	0	^
0	1	1	1	1	1	_

6 BIT BLOCK						IA5
MSB					LSB	CHARACTER
1	0	0	0	0	0	`
1	0	0	0	0	1	a
1	0	0	0	1	0	b
1	0	0	0	1	1	c
1	0	0	1	0	0	d
1	0	0	1	0	1	e
1	0	0	1	1	0	f
1	0	0	1	1	1	g
1	0	1	0	0	0	h
1	0	1	0	0	1	i
1	0	1	0	1	0	j
1	0	1	0	1	1	k
1	0	1	1	0	0	l
1	0	1	1	0	1	m
1	0	1	1	1	0	n
1	0	1	1	1	1	o
1	1	0	0	0	0	p
1	1	0	0	0	1	q
1	1	0	0	1	0	r
1	1	0	0	1	1	s
1	1	0	1	0	0	t
1	1	0	1	0	1	u
1	1	0	1	1	0	v
1	1	0	1	1	1	w
1	1	1	0	0	0	x
1	1	1	0	0	1	y
1	1	1	0	1	0	z
1	1	1	0	1	1	{
1	1	1	1	0	0	}
1	1	1	1	0	1	~
1	1	1	1	1	0	DEL

NOTE: TABLE 2 is a subset of the DPNSS 1 Character Coding Table (DPNSS[188], SECTION 4, ANNEX 4, TABLE 1).

The codes for the IA5 characters assigned as a result of the 3B4I encoding process can be derived from the corresponding 6 bit block by the addition of a "1" in the seventh (most significant) bit position. For example, 6 bit block "000101" is assigned IA5 character "E" and the IA5 code for "E" is "1000101".

On receipt of this Parameter the most significant bit (bit 7) is stripped from each IA5 code, the resulting 6 bit blocks are assembled, four at a time, to make 24 bit blocks; each 24 bit block is split into three binary octets.

Where the number of IA5 characters in the Parameter is not a multiple of four, there will be either two or three 6 bit blocks remaining to be decoded.

In the case where two 6 bit blocks remain, the four least significant bits (zeros) of the last block are discarded and the remaining bits are concatenated to make one binary octet.

In the case where three 6 bit blocks remain, the two least significant bits (zeros) of the last block are discarded and the remaining 16 bits are split to make two binary octets.

Examples of 3B4I encoding:

i. the octets 10100000
01010000
01000001 would be encoded as: hEAA in IA5

ii. the octets 10100000
01010000
01000001
01000111 would be encoded as: hEAAQp in IA5

iii. the octets 10100000
01010000
01000001
01000111
01000011 would be encoded as: hEAAQtL in IA5

DIGITAL PRIVATE NETWORK SIGNALLING SYSTEM NO 1 (DPNSS 1)

SECTION 4

ANNEX 3 : CODING OF CLEARING/REJECTION CAUSES

CONTENTS

TABLE OF DPNSS 1 CLEARING/REJECTION CAUSE CODES Page 2

HISTORY

Issue 1 - May 1983
Issue 2 - February 1984
Issue 3 - September 1984
Issue 4 - March 1986
Issue 5 - December 1989
Issue 6 - January 1995

Issue 7 - March 2001 - Specification renamed as DPNSS[188]

TABLE OF DPNSS 1 CLEARING/REJECTION CAUSE CODES

MNEMONIC	CLEARING/ REJECTION CAUSE	MEANING	HEX VALUE
AB	Access Barred	Used when a particular caller is barred access to outgoing routes.	29H
ACK	Acknowledgement	Used to inform the Requesting PBX that the Supplementary Service has been (or is being) carried out.	14H
AI	Address Incomplete	Used when insufficient address digits have been received to achieve a valid address, unless conflict dialling is permitted. Where conflict dialling is permitted, NU shall be used.	01H
BY	Busy	Used when the called party is engaged on a call.	08H
CHOS	Channel Out of Service	Used to reject a call received on a channel which is out of service or uninstalled.	23H
CNR	DTE Controlled Not Ready	Used when the called X.21 terminal is in the "Controlled Not Ready" state.	2DH
CON	Congestion	Used when PBX equipment or suitable routes are busy.	07H
CT	Call Termination	Used when a party releases a call by clearing in the normal way.	30H
FNR	Facility Not Registered	Used when a PBX receives a request relating to a service where previous knowledge of its existence is necessary, but that knowledge does not exist (e.g., a Call Back When Free call made to a PBX with no record of the original registration).	18H
ICB	Incoming Calls Barred	Used when the called party is barred to incoming calls.	0AH
INC	Service Incompatible	Used when the route available does not conform to the required SIC.	13H

TABLE OF DPNSS 1 CLEARING/REJECTION CAUSE CODES

MNEMONIC	CLEARING/ REJECTION CAUSE	MEANING	HEX VALUE
MNU	Message Not Understood	Used when rejecting an unrecognised message on an idle channel. Note that the channel on which MNU was received may not be the one on which the unrecognised message was detected because Transit PBXs pass on Clearing Causes unchanged.	1AH
NAE-E	Network Address Extension-Error	Used to inform the Requesting PBX that a call has been rejected because of failure to process the received NAE data.	1EH
NT	Network Termination	Used when the call is released by the network for any reason (e.g., due to a timeout expiring, or service interactions).	02H
NU	Number Unobtainable	Used when the Destination Address is invalid (i.e., spare).	00H
PFR	Priority Forced Release	Used when an authorised intruding party forces the release of an unwanted party, e.g., an operator or a party with the required Breakdown Capability	24H
REJ	Reject	Used when the requesting or requested party of a Supplementary Service rejects the service (e.g., Wanted party rejects a Call Offer request).	19H
ROS	Route Out of Service	Used when all suitable routes are out of service.	1CH
SI	Subscriber Incompatible	Used when the called party does not conform to the requested SIC.	04H
SNU	Signal Not Understood	Used when rejecting message contents which have not been understood. This CC is accompanied by the string SNU. SNU either identifies a String which has not been understood or indicates another reason for not understanding the message (e.g., syntax error).	15H

TABLE OF DPNSS 1 CLEARING/REJECTION CAUSE CODES

MNEMONIC	CLEARING/ REJECTION CAUSE	MEANING	HEX VALUE
SNV	Signal Not Valid	Used only when a PBX working to Issue 1 of DPNSS 1 rejects a String that is invalid.	16H
SOS	Subscriber Out of Service	Used when the called party is out of service.	09H
SSI	Signalling System Incompatible	Used when the requested Service is not supported by the route available and there is no other suitable route.	1BH
STU	Service Temporarily Unavailable	Used when the requested Service is available on the PBX but can not be provided at the moment.	17H
SU	Service Unavailable	Used when the requested Service is supported by the PBX but not by the called party. This Clearing Cause is accompanied by the String SU which identifies the service being rejected.	03H
TRFD	Transferred	Used (by Issues 2 & 3 PBXs only) to instruct the Branching PBX of a 3-party call to connect the two remaining parties together.	1DH
UNR	DTE Uncontrolled Not Ready	Used when the called X.21 terminal is in the "Uncontrolled Not Ready" state.	2EH

All other Clearing Cause values, with the exception of those encountered when interworking with DASS 2, are invalid within DPNSS 1 at present. Reference should be made to BTNR 190 and the individual Service and Supplementary Service Sections of DPNSS[189] for Clearing Causes used when interworking with DASS 2.

DIGITAL PRIVATE NETWORK SIGNALLING SYSTEM NO 1 (DPNSS 1)

SECTION 4

ANNEX 4 : ALPHANUMERIC CHARACTER SET

CONTENTS

1	ALPHANUMERIC CHARACTER SET	Page 2
2	TABLE 1 CHARACTER CODING - UK ISDN VERSION	Page 3

HISTORY

- Issue 1 - May 1983
- Issue 2 - February 1984
- Issue 3 - September 1984
- Issue 4 - March 1986
- Issue 5 - December 1989
- Issue 6 - January 1995

- Issue 7 - March 2001 - Specification renamed as DPNSS[188]

1 ALPHANUMERIC CHARACTER SET

All alphanumeric characters in messages exchanged between PBXs shall be coded in accordance with Table 1, which is closely aligned with CCITT Recommendation V.3 "International Alphabet No. 5".

The coding shown in Table 1 differs from CCITT Recommendation V.3 by using the bit combination of position 2/4 to represent the pound sign (£). In all other respects, Table 1 is in accordance with Recommendation V.3, with the permissible option of using position 2/3 for the number sign (#) being implemented.

The following abbreviations are used in Table 1:

BEL	Bell
CAN	Cancel
DC	Device Control
DEL	Delete
EM	End of Medium
ESC	Escape
FE	Format Effector
IS	Information Separator
NUL	Null
SI	Shift-In
SO	Shift-Out
SP	Space
SUB	Substitute Character
TC	Transmission Control

2 TABLE 1 CHARACTER CODING - UK ISDN VERSION

BITS				R O W	COLUMN							
b4	b3	b2	b1		0	1	2	3	4	5	6	7
0	0	0	0	0	NUL	TC7	SP	0	@	P	'	p
0	0	0	1	1	TC1	DC1	!	1	A	Q	a	q
0	0	1	0	2	TC2	DC2	"	2	B	R	b	r
0	0	1	1	3	TC3	DC3	#	3	C	S	c	s
0	1	0	0	4	TC4	DC4	£	4	D	T	d	t
0	1	0	1	5	TC5	TC8	%	5	E	U	e	u
0	1	1	0	6	TC6	TC9	&	6	F	V	f	v
0	1	1	1	7	BEL	TC10	'	7	G	W	g	w
1	0	0	0	8	FE0	CAN	(8	H	X	h	x
1	0	0	1	9	FE1	EM)	9	I	Y	i	y
1	0	1	0	10	FE2	SUB	*	:	J	Z	j	z
1	0	1	1	11	FE3	ESC	+	;	K	[k	{
1	1	0	0	12	FE4	IS4	,	<	L	\	l	
1	1	0	1	13	FE5	IS3	-	=	M]	m	}
1	1	1	0	14	SO	IS2	.	>	N	^	n	~
1	1	1	1	15	SI	IS1	/	?	O	_	o	DEL

Bit 8 of an octet containing an IA5 character may optionally be used to indicate parity. Its use in DPNSS 1 is undefined and it should be ignored.

Note: The significance of the following graphic characters is given below:

<u>Position (Column/row)</u>	<u>Significance</u>
2/2	Quotation Mark
2/7	Apostrophe
2/12	Comma
5/14	Upward Arrow Head
5/15	Underline
6/0	Grave Accent
7/14	Tilde

DIGITAL PRIVATE NETWORK SIGNALLING SYSTEM NO 1 (DPNSS 1)

SECTION 4

ANNEX 5 : MESSAGE TYPE CODES

CONTENTS

1	Call Control Message Group	Page 2
2	End-To-End Message Group	Page 3
3	Link-By-Link Message Group	Page 3

HISTORY

Issue 1 - May 1983
Issue 2 - February 1984
Issue 3 - September 1984
Issue 4 - March 1986
Issue 5 - December 1989
Issue 6 - January 1995

Issue 7 - March 2001 - Specification renamed as DPNSS[188]
- New NSIM message type code introduced

1 CALL CONTROL MESSAGE GROUP (GROUP CODE 0000)

TYPE CODE	MESSAGE
Bits 4 3 2 1	
0 0 0 0	ISRM(C)
0 0 0 1	ISRM(I)
0 0 1 0	RM(C)
0 0 1 1	RM(I)
0 1 0 0	Note 1
0 1 0 1	CCM
0 1 1 0	NIM
0 1 1 1	Note 1
1 0 0 0	CRM/CIM
1 0 0 1	NAM
1 0 1 0	RRM
1 0 1 1	SSRM(I)
1 1 0 0	SSRM(C)
1 1 0 1	Note 1
1 1 1 0	Note 1
1 1 1 1	Spare

Note 1: These codes are used in DASS 2

2 END-TO-END MESSAGE GROUP (GROUP CODE 0010)

TYPE CODE	MESSAGE
Bits 4 3 2 1	
0 0 0 0	Note 1
0 0 0 1	Note 1
0 0 1 0	EEM(C)
0 0 1 1	EEM(I)
0 1 0 0	SCRM
0 1 0 1	SCIM
0 1 1 0	ERM(C)
0 1 1 1	ERM(I)
1 0 0 0	NSIM

All other Codes in the End-to-End Message Group are spare.

3 LINK-BY-LINK MESSAGE GROUP (GROUP CODE 0100)

TYPE CODE	MESSAGE
Bits 4 3 2 1	
0 0 0 0	LLM(C)
0 0 0 1	LLM(I)
0 0 1 0	LLRM
0 0 1 1	Note 1
0 1 0 0	SM
0 1 0 1	LMM
0 1 1 0	LMRM

All other Codes in the Link-by-Link Message Group are spare.

DIGITAL PRIVATE NETWORK SIGNALLING SYSTEM NO 1 (DPNSS 1)

SECTION 4

ANNEX 6 : MAINTENANCE ACTIONS

CONTENTS

TABLE OF MAINTENANCE ACTIONS Page 2

HISTORY

Issue 1 - March 1986

Issue 2 - December 1989

Issue 3 - January 1995

Issue 4 - March 2001 - Specification renamed as DPNSS[188]

1 TABLE OF MAINTENANCE ACTIONS

Code	Mnemonic	Action	Meaning
00000001	BBC	Back-Busy Control	Used to request an action relating to the back-busy state of traffic channels.
00000010	LBC	Loop-Back Control	Used to request an action relating to the looping-back of traffic channels.
00000011	LBA	Loop-Back Abort	Used to request the PBX controlling a loop-back to cancel the loop-back.
00000100	TCS-R	Traffic Channel Status Request	Used to request the current status of traffic channels.
00000101	ACK	Acknowledge	Used to inform the Requesting PBX that the request has been (or is being) carried out.
00000110	NTC	Non-Looped-Back Test Control	Used to request an action relating to testing channels in a non-looped-back mode.

DIGITAL PRIVATE NETWORK SIGNALLING SYSTEM NO 1 (DPNSS 1)

SECTION 4

ANNEX 7 : CODING OF USAGE IDENTIFIERS

CONTENTS

1	GENERAL	Page 2
2	USAGE IDENTIFIER STRUCTURE	Page 2

HISTORY

Issue 1 - March 2001

1 GENERAL

The Usage Identifier is used in NSIM messages to indicate the nature of the manufacturer specific information contained within the remainder of the message. The use of NSIMs is described in greater detail in SECTION 49.

2 USAGE IDENTIFIER STRUCTURE

The Usage Identifier consists of one or more octets with the following structure.

BIT	8	7	6	5	4	3	2	1
OCTET 1	ext	Manufacturer code					subcode	

FIGURE 1: STRUCTURE DIAGRAM

Where bit 8 of a Usage Identifier octet is set, this indicates that there is a subsequent octet such that bits 7 to 1 of the first octet are used in conjunction with the subsequent octet(s). Where bit 8 of a Usage Identifier octet is zero, this indicates that it is the final octet of the Usage Identifier.

Bits 7 to 3 of the first octet contain the Manufacturer code. A list of the Manufacturer codes currently allocated along with an explanation of how to obtain a new code is contained in SECTION 49.

Bits 2 to 1 of the first octet contain a manufacturer defined subcode which allows four different Usage Identifiers to be derived from a single Manufacturer code.

DIGITAL PRIVATE NETWORK SIGNALLING SYSTEM NO 1 (DPNSS 1)

SECTION 5 - LEVEL 3 SIGNALLING PROCEDURES

CONTENTS

1	GENERAL	Page 3
2	DPNSS 1 LEVEL 3 SPECIFICATION FORMAT	Page 4
	2.1 Service Section Format	Page 4
	2.2 MSD Symbols	Page 4
	2.3 SDL Diagrams	Page 4
3	GENERAL CALL CONTROL SIGNALLING PROCEDURES	Page 7
	3.1 Initial Call Establishment	Page 7
	3.2 DPNSS 1 Channel Release Sequence	Page 8
	3.3 Supplementary Services	Page 9
	3.4 Single-Channel Working	Page 10
	3.5 Manufacturer Specific Signalling	Page 17
	3.6 Virtual Calls	Page 17
	3.7 Call Collision	Page 17
4	CALL CONTROL ERROR HANDLING PROCEDURES	Page 20
	4.1 Reaction to Unrecognised Messages	Page 20
	4.2 Reaction to an Incomplete or Oversize Message Sequence	Page 24
	4.3 Reaction to Unrecognised Supplementary Information Strings	Page 28
	4.4 Reaction to Missing Strings	Page 39
	4.5 Reaction to Unrecognised SIC	Page 39
	4.6 Reaction to Unrecognised Or Missing Clearing Cause	Page 40
	4.7 Reaction to Syntax Error	Page 40
	4.8 Reaction to Non-Receipt of a Response During End-to-End Signalling	Page 42
5	GENERAL MAINTENANCE SIGNALLING PROCEDURES	Page 43
	5.1 Introduction	Page 43
	5.2 Reaction to Unrecognised Supplementary Information Strings in LMM	Page 43
	5.3 Reaction to Message with Unrecognised Maintenance Action	Page 44
	5.4 Reaction to Missing Strings	Page 44
	5.5 Reaction to an Unrecognised or Missing Rejection Cause	Page 44
	5.6 Reaction to Syntax Error	Page 44
6	COMPLIANCE	Page 45

ANNEXES TO SECTION 5:

ANNEX 1: MESSAGE SEQUENCE DIAGRAM (MSD) SYMBOLS

ANNEX 2: SDL SYMBOLS AND DESCRIPTIONS

ANNEX 3: SDL DIAGRAMS FOR CHANNEL PROCESS AND MAINTENANCE
PROCESS

ANNEX 4: INTERACTION OF SUPPLEMENTARY SERVICES

HISTORY

Issue 1 - May 1983

Issue 2 - February 1984

Issue 3 - September 1984

Issue 4 - March 1986

Issue 5 - December 1989

Issue 6 - March 2001 - Specification renamed as DPNSS[188]
- Paragraph added on Manufacturer Specific Signalling
- Clarification added to the handling of call collisions
- Option added for the handling of unrecognised ISRMs

REFERENCES

CEPT Services and Facilities Handbook SF2 (SECTION III)

CCITT Recommendations (Yellow Book 1980) Z.101, Z.102 and Z.104.

1 GENERAL

1.1 The Level 3 signalling procedures detailed in this specification are considered in two parts:

- a) General signalling procedures that are common to all services eg call failure, receipt of inappropriate or unrecognisable signals, etc, and
- b) The signalling procedures for each individual service, eg Simple Call or Supplementary Service.

The general signalling procedures are given in this Section of the specification; the signalling procedures for each service are given in separate sections of the specification, commencing at SECTION 6.

1.2 Subsection 2 describes the conventions used for the specification of DPNSS 1 Level 3 procedures.

1.3 Subsection 3 describes the general call control procedures that are common to Simple Calls and Supplementary Services.

1.4 Subsection 4 describes the DPNSS 1 Level 3 error-handling procedures for dealing with unrecognised messages and unrecognised-message contents.

1.5 Subsection 5 describes the DPNSS 1 maintenance-signalling procedures.

1.6 Subsection 6 shows the Compliance.

2 DPNSS 1 LEVEL 3 SPECIFICATION FORMAT

2.1 SERVICE SECTION FORMAT

Normally each Service or Supplementary Service Section is written to a standard format, as described below:

- i Definition of Service
- ii Description
- iii Outline of Operation including Message Sequence Diagrams (MSDs) plus explanatory notes
- iv Compliance Statement

In general within the Simple Call and Supplementary Service Sections of this specification the description is given in terms of extensions which have associated with them Calling/Called Line Category Ordinary (CLC-ORD). Unless explicitly stated otherwise the signalling sequences shall apply equally to calls involving Operators except that CLC-ORD shall be replaced with CLC-OP. Under these circumstances references to extensions shall be read as references to operators.

The presence of CLC-OP may be used by the receiving PBX to grant an operator certain privileges or to deny the local party certain privileges. See also the Centralised Operator Supplementary Service in SECTION 26 of this specification.

2.2 MSD SYMBOLS

The Message Sequence Diagrams in each Section conform to a standard layout. A key to the symbols used is given in ANNEX 1 to this Section.

2.3 SDL DIAGRAMS

2.3.1 The SDL diagrams included in this specification are to assist in the understanding of the technical text, and must only be used in association with the MSDs and text.

The SDL diagrams are for explanation and overall functional specification only and are not intended to show the required method of realising DPNSS 1. However overall functional compliance for a given service or situation must be achieved.

2.3.2 For the purpose of SDL representation a PBX is considered to comprise a number of interacting but separate processes; Figure A shows the Level 3 Processes.

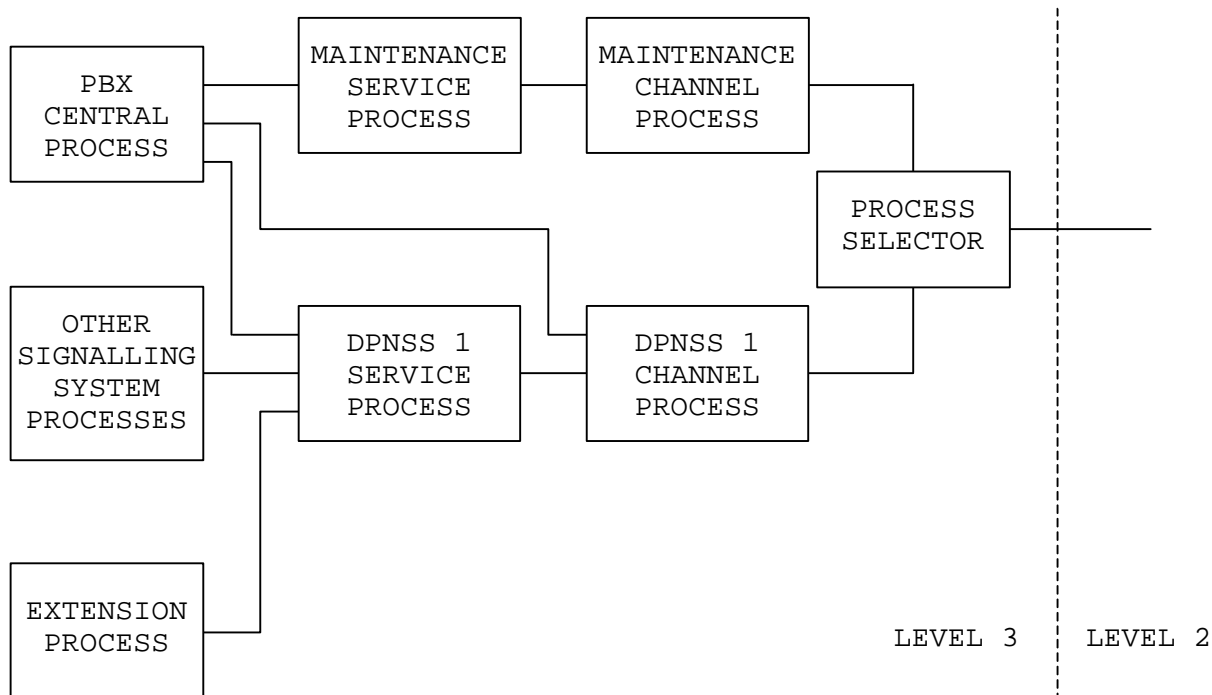

FIGURE A

The DPNSS 1 Channel Process and the DPNSS 1 Service Process represent the DPNSS 1 Call Control requirements. The Maintenance Channel Process and the Maintenance Service Process represent the DPNSS 1 Traffic Channel Maintenance requirements. The Extension Process, Other Signalling System Process and PBX Central Process are not part of DPNSS 1 and although their internal procedures are implied within this specification they are not specified in detail.

2.3.3 The DPNSS 1 Channel Process deals with the procedures that are detailed in Subsections 3 and 4 of this Section, eg handling of Unrecognised Messages, analysis of Supplementary Information Strings, Clearing Sequences, etc. There is a Channel Process associated with each end of every DPNSS 1 channel, including Virtual Channels. The SDL for the DPNSS 1 Channel Process is given in ANNEX 3 of this Section.

2.3.4 The Service Process describes the behaviour of a PBX when controlling Simple Calls and Supplementary Services.

The Service Process will communicate with one or more Channel Processes depending upon the service concerned and the PBX function (eg End, Transit or Branching) being provided.

2.3.5 The Maintenance-Channel Process deals with the procedures that are detailed in Subsection 5 of this Section eg the handling of Link Maintenance Messages and the analysis of their contents. These messages are then passed to the Maintenance Service Process.

The Maintenance-Channel Process is only provided on PBXs that support the Traffic-Channel Maintenance Supplementary Service (SECTION 27). When provided there is a Maintenance Channel Process associated with every DPNSS 1 channel, including Virtual Channels.

The Maintenance Channel Process SDL is given in ANNEX 3 to this Section.

2.3.6 The Maintenance Service Process describes the behaviour of a PBX when controlling the Link Maintenance Supplementary Service and appears in SECTION 27 of this specification.

2.3.7 The Process Selector separates the Maintenance messages from the Call Control messages and passes them transparently to the appropriate channel process.

Unrecognised messages are treated as Call Control messages and passed to the DPNSS 1 Channel Process.

If the PBX does not support the Traffic Channel Maintenance Supplementary Service the Process Selector shall pass any received maintenance messages to the Call Control Channel Process. The Process Selector SDL is given in ANNEX 3 to this Section.

2.3.8 The Level 2 processes are described in SECTION 3 of this specification.

2.3.9 A brief outline of the symbols and conventions used in the Level 3 SDL within this specification along with schematic diagrams of the possible PBX configurations is given in ANNEX 2 to this Section.

3 GENERAL CALL CONTROL SIGNALLING PROCEDURES

3.1 INITIAL CALL ESTABLISHMENT

The message interchange during initial call establishment on a DPNSS 1 channel is standard irrespective of the use (Simple Call or Supplementary Service) to which the channel is to be put.

To establish a call the Originating PBX sends an Initial Service Request Message (ISRM). The ISRM contains the Service Indicator Code, Calling Line Category, Destination Address and if appropriate other Supplementary Information, eg Originating Line Identity, Supplementary Service requests etc.

On receipt of an ISRM, a PBX will analyse the destination address to determine whether the called party is:

- on that PBX, or
- via another signalling system, or
- via another DPNSS 1 link.

If the call is to be routed on over another DPNSS 1 link the PBX becomes a Transit PBX for that call and sends an ISRM to the next PBX. Otherwise the PBX becomes an End PBX.

Network Indication Messages (NIMs) are used to notify the originating PBX of events that take place during the routing phase of a call, eg "Alternative route encountered"

Depending upon the contents of the ISRM and the State of Destination (SOD), the End PBX will either send a Number Acknowledgement Message (NAM) and maintain the call, or release the connection by sending a Clear Request Message (CRM). The NAM marks the end of the routing phase of a call.

Signals within the NAM will usually indicate the Called Line Category, the Called Line Identity if available, and if appropriate other supplementary information.

A CRM is used when a Simple Call encounters call failure, eg busy etc or as a response to a Supplementary Service Request when no further signalling other than acknowledgement or rejection is appropriate. When a CRM is received indicating call failure where the end destination has not been reached (eg a CRM containing Clearing Cause: Congestion) a PBX may make a further attempt to route the call forward (Alternative Routing).

If the response by the Terminating PBX is a NAM, then the call has entered the established phase. The call remains in the established phase until the sending of a CRM when it enters the clearing phase (see paragraph 3.2). During the established phase of a call, a Call Connect Message (CCM) will be sent if the call is answered. Other messages are defined for use during the established phase of a call for Supplementary Service Signalling (see paragraph 3.3).

NOTE: Call establishment may be carried out by means of an ISRM (Complete) [ISRM(C)] or an ISRM (Incomplete) [ISRM(I)] plus a number of Subsequent Service Request Messages (SSRMs). The latter procedure may be used to reduce post-dialling delays in networks that include slow signalling systems. ISRM(I) and SSRMs may also be used from Originating PBXs that cannot determine when dialling is complete or when the supplementary information to be sent cannot all be contained within an ISRM(C).

A PBX should take steps to minimise the use of SSRMs over a satellite link, because of the time taken to acknowledge each message at Layer 2.

3.2 DPNSS 1 CHANNEL RELEASE SEQUENCE

The Channel Release Sequence may be used in a number of circumstances; examples are:

- to end an established call;
- to conclude a Supplementary Service request sequence;
- under call failure conditions;
- on unsuccessful call set-up, eg busy.

The Release Sequence is initiated by the sending of a CRM.

When a PBX receives a CRM it releases the connection or Virtual Call and returns a CIM. The contents of the CIM shall be an exact copy of that of the received CRM. The clearing sequence is carried out on a link by link basis. It should be noted that the Group/Type code is the same for CRM and CIM.

If after a CRM has been sent a CIM is not received within 10 ± 1 s, the PBX shall repeat the CRM and continue waiting for the CIM.

3.2.1 Call Clearing

Either party in an established call can initiate the clearing sequence.

3.2.2 Clearing at a Transit PBX

Where a Transit PBX is initiating clearing on one link as a result of clearing occurring on the other link, the CRM sent shall be an exact copy of the one received. An exception to this may occur under the conditions of alternative routing.

3.2.3 Clearing After Alternative Routing

If a call that has been alternatively routed by a Transit PBX fails and the Clearing Cause received in a CRM indicates that an end destination has not been reached (eg CC=ROS), then depending on PBX design, the Transit PBX which initiated alternative routing shall:

- attempt a further alternative route, or
- Repeat the CRM backwards unchanged, or
- Return a copy of any CRM previously returned on the primary route or other alternative routes, in order to reflect back to the previous PBX the condition of one of the other routes rather than the condition of the last tried route.

This allows a PBX to select the most appropriate reason for call failure to return towards the Originating PBX.

If the Clearing Cause received on an alternative route implies that the end destination has been reached (eg Clearing Cause: Busy) then the CRM received on the alternative route shall be repeated back towards the Originating PBX, irrespective of the contents of any CRM received on any other route.

3.2.4 PBX Failure

The clearing sequence may be automatically initiated during a call by any PBX due to system failure. A Transit PBX under failure conditions shall clear the call in both directions using the procedures detailed in Para 3.2. The Clearing Cause shall be Network Termination (NT).

3.3 SUPPLEMENTARY SERVICES

Supplementary Services are signalled in a number of different ways as follows:

- a) By the inclusion of additional Supplementary Information Strings within the initial call establishment messages (see paragraph 3.1).
- b) By the use of End to End and Link By Link messages during the established phase of a call.
- c) By the establishment of a new call, related to an existing call. This may be achieved by establishing a totally new call as for case a) above, or where the option is defined in the service in question, by utilising some or all of the existing call's path. The latter technique is called Single-Channel Working and is described in paragraph 3.4.

During the established phase of a call supplementary information can be passed between end PBXs using End-to-End messages (EEM)s, or between adjacent PBXs using Link-by-Link messages (LLM)s.

Normally an EEM(C) or LLM(C) is used. Where the supplementary information cannot be fitted into a single message an EEM(C) or LLM(C) is preceded by one or more EEM(I) or LLM(I) respectively.

The PBX that originates a sequence of EEMs/LLMs shall not send any other message during the sending of that sequence.

An End or Branching PBX shall buffer any received EEM(I)s until an EEM(C) is received and then process the supplementary information from the complete EEM(I) plus EEM(C) sequence as if it had been received in a single EEM(C). A Transit PBX shall always pass on an EEM sequence without modification although it may buffer EEM(I)s before passing them on.

All PBXs shall buffer any received LLM(I)s until an LLM(C) is received and then process the supplementary information contained in the complete LLM sequence as if it had been received in a single LLM(C).

3.4 SINGLE-CHANNEL WORKING

3.4.1 Second Call Establishment Over The Same Channel

If a second call is to follow some or all of the route of the call to which it is related, then it may optionally share the same channel (Single Channel Working), in which case a Recall Message (RM) is used. The shared channel is said to be in dual use. The RM contains the Service Indicator Code, Calling Line Category, Supplementary Service Request and Destination Address.

If the Destination Address within an RM, received at a Transit PBX, indicates that the new call can continue to follow the same route the RM is passed on. The PBX becomes a Transit PBX for the second call also.

If the Destination Address within an RM, received at either a Transit PBX or an End PBX, indicates that the new call must follow a new DPNSS 1 route the PBX becomes a Branching PBX for both calls and a Transit PBX for the new call and sends an ISRM forward on the new channel.

If the Destination Address within a RM, received at either a Transit or an End PBX indicates either a terminal on that PBX or a route via another signalling system, the PBX becomes a Branching PBX for both calls and an End PBX for the new call.

If the existing call path is cleared from the other end such that the RM and CRM cross on the channel then the action taken is Supplementary Service specific and is detailed in

the appropriate Section of this specification. In all cases one of the following events will occur:

an RRM containing Rejection Cause: NT is sent to the Controlling PBX and the clearing continues as normal;
or
the CRM is acknowledged, the call path back to the controlling PBX is retained and the call is routed forward using an ISRM.

Supplementary Services which require the new call to unconditionally share the whole of the path of the existing call as far as its End PBX, use an End to End Recall message (ERM). An example of this occurs in the Add On Conference Service (SECTION 29), where it is used to ensure that all calls are routed via the Conference PBX.

NOTE: Establishment of a second call may be carried out by means of either a RM(C)/ERM(C) or a RM(I)/ERM(I) plus a number of SSRMs.

Transit PBXs unconditionally repeat ERMs, and become Transit PBXs for the new call also. An End PBX will treat an ERM as an RM and, subject to the Destination Address, become either a Branching and End PBX, or a Branching and Transit PBX for the new call. Since ERMs and any subsequent SSRMs are unconditionally passed on by Transit PBXs, it follows that the SIC used for the new call must be compatible with the existing call path. Furthermore, since no analysis of the message contents is performed by the Transit PBXs, no Strings that are Mandatory or Optional for Transit PBXs should be included in ERMs unless these Strings are solely of relevance to those PBXs that may be involved in the establishment of any new call path beyond the existing End PBX.

NIMs are used to notify the new call's Originating PBX of events that take place during the routing phase, eg alternative route encountered.

During the establishment of the second call EEMs, LLMs and CCMs may be passed backwards or forwards along the path of the original call.

On completion of the routing phase the new call's Terminating PBX will return either a NAM or a CRM (see paragraph 3.1). The Branching PBX will:

- repeat the NAM towards the new call's Originating PBX, or
- return a CIM to the new call's Terminating PBX and send a RRM along the shared path towards the new call's Originating PBX. The contents of the CRM shall be included in the RRM.

If the new call's Terminating PBX is also the Branching PBX it will return an RRM directly instead of a CRM.

Any Transit PBXs along the shared path will:

- repeat the NAM towards the new call's Originating PBX,
- depending upon the Rejection Cause, either:

Repeat the RRM towards the new call's Originating PBX.

or

Alternatively route the new call via a new channel and become a Branching PBX. Alternative routing is not permissible following an ERM.

3.4.2 Second Call Establishment From Both Ends Of A Call

An RM may be received on the held or connected channels of a Branching Transit. The RM shall be processed but the action taken shall depend upon the Destination Address in the received RM as follows:

- If the Destination Address indicates that the required party is an extension on the Branching PBX then the PBX shall become both a Branching and End PBX for the new call and a Branching PBX for the existing call.
- If the Destination Address indicates that required party is on another DPNSS 1 PBX then, since the onward path is already in dual use the new call shall use a new channel.

The PBX therefore performs two simultaneous Branching functions.

3.4.3 Partial Support of Single-Channel Working

It is permissible for a PBX to only partially support Single-Channel Working in as much that it recognises an RM but does not provide the Branching function. Under these circumstances if the Destination Address indicates that the same route can be followed then the RM may be passed to the next PBX, subject to other checks appropriate to a Transit PBX, eg SIC.

3.4.4 Rejection of Single-Channel Working

Single-Channel Working is an optional part of each service to which it applies.

If a Transit or End PBX, which does not support Single-Channel Working, receives an RM in a state where an RM is valid, it rejects it by returning a Recall Reject Message (RRM) containing the Rejection Cause: SNU plus a Supplementary Information String RR-SNU with Parameter R.

On receipt of an RRM containing RR-SNU a Transit PBX with branching capability will route the new call over a new DPNSS 1 channel thus becoming a Branching PBX.

If the Transit PBX is unable to become a Branching PBX it will repeat the RRM to the preceding PBX.

If the Originating PBX receives a RRM containing RR-SNU it will re-route the second call over a new DPNSS 1 channel thus becoming a Branching and End PBX, ie Separate Channel Working then applies.

If a Transit PBX which does not support Single Channel Working receives an ERM, it will pass on the ERM as an unrecognised message and remain a Simple Transit. If an End PBX which does not support Single Channel Working receives an ERM, it may either:

- ignore the ERM as an unrecognised message.

or preferably,

- reject the ERM by returning an RRM containing the Rejection Cause SNU plus an Information String RR-SNU with the Parameter "R".

After sending or passing on an ERM, if an RRM containing RR-SNU is received, an Originating or Transit PBX shall not re-route the call over a separate channel.

3.4.5 Signalling on a Channel in Dual Use

Some Supplementary Services, eg Diversion, result in the first call being cleared as soon as a second call has been established; others, eg Enquiry, retain both calls.

On Supplementary Services that retain both calls, it is necessary after establishment of the second call to be able to differentiate between the two calls when signalling via any shared channels.

This is done by means of the Supplementary Information String: Connected Call (COC). The Connected Call is the one currently using the shared traffic channel.

This String is added to SCRMs, SCIMs, SMS CCMs and a sequence of EEMs or LLMs as they are passed between the Branching PBX and the Controlling PBX (the second call's Originating PBX) to indicate that the message relates to the Connected Call and not the Held Call. If the Branching PBX receives one of these messages/sequences from the connected channel it inserts String COC before passing it on along the shared channel. If the Branching PBX receives one of these messages containing String COC from the shared channel it removes the String before passing it on along the connected channel. If a message is received without the COC String it is passed along the Held Channel.

NOTE: Before the NAM is sent on the new call, EEMs, LLMs, SCIMs, SCRMs, SMS and CCMs can relate only to the Held (original) Call and do not carry this String.

If a Branching PBX receives an ERM on either the connected or held channel then the ERM shall be rejected by means of an RRM containing RC:STU.

3.4.6 Third Call Establishment Over The Same Channel

Certain Supplementary Service interactions (eg, Diversion of an Enquiry call) may result in the Controlling PBX setting up a third call, the existing Connected Call (eg Enquiry Call) being cleared as soon as the third call (eg Diverted Enquiry Call) has been established. If the third call is to follow some or all of the route of the existing Connected Call it may optionally share the same channel.

If the original Enquiry Call was itself sharing a channel with the Held Call then the channel is now in triple use. The third call may branch either before the existing Branching PBX, at the existing Branching PBX or after the existing Branching PBX (on the connected path). The third call is established by means of an RM or ERM, to which the response is either a NAM or an RRM. At the existing Branching PBX an RM or ERM shall not be passed along the held channel but may be passed along the existing connected channel.

Having sent an RM or ERM, and before receipt of a NAM or RRM, any EEMs LLMs and CCMs may continue to be passed on behalf of the existing held and Connected Calls, using String COC in the case of the Connected Call.

After a NAM has been sent back the new call is treated as the Connected Call, the original Connected Call having been cleared by the third call's Branching PBX. Any EEMs, LLMs, or CCMs relating to it will use String COC.

3.4.7 Shared-Channel Release Sequence

On Supplementary Services which retain both calls, eg Enquiry by means of Single-Channel Working, the following sequence is used to release individual calls.

To initiate the shared-channel release sequence the Controlling or Branching PBX sends an SCRM and expects an SCIM in response. The SCRM shall contain String COC if the Connected Call is being cleared.

Each Transit PBX along the shared path repeats the SCRM on to the next PBX.

When the Controlling PBX or the Branching PBX receives an SCRM it responds with an SCIM and releases the appropriate call.

Each Transit PBX along the shared path repeats the SCIM to the next PBX.

If while awaiting an SCIM the Controlling or Branching PBX receives an SCRM indicating that the same call has been released from the opposite direction it returns an SCIM and continues to await an SCIM.

If while awaiting an SCIM without String COC the Controlling or Branching PBX receives an SCRM with String COC or vice versa, this indicates that the remaining call has been released from the opposite direction. The PBX sends a CRM, expecting a CIM in response, and releases the remaining call.

If while awaiting an SCIM the Controlling or Branching PBX receives an EEM, LLM, SM or CCM it must discard it unless it relates to the remaining call.

A PBX shall not send an RM along a Channel from which it is awaiting an SCIM.

If after an SCRM has been sent a SCIM is not received within 10 ± 1 s the PBX shall repeat the SCRM and continue waiting for the SCIM.

If an SCRM or SCIM is received by a PBX that does not support Single Channel Working the messages shall be handled as unrecognised (see paragraph 4.1).

If an End or Branching End PBX receives an SCRM on a channel that is not in dual use then it shall return an SCIM.

3.4.7.1 Call Release on a Channel in Dual Use

The shared-channel release sequence may be initiated on behalf of either call at any time after the new call's NAM by either the Controlling PBX or the Branching PBX.

Before the new call's NAM the shared-channel release sequence may only be initiated by the controlling PBX in order to release the new call.

3.4.7.2 Call Release During The Establishment of a Third Call

The shared-channel release sequence may be initiated during establishment of the third call by either the Controlling PBX or the original call's Branching PBX in order to clear the Connected Call.

If the Connected Call is cleared, then the third call's Branching PBX shall initiate the clearing of the third call also. The call between the Controlling PBX and the Held PBX returns to Simple Call with the intervening channels no longer in dual use.

The shared channel release sequence shall not be initiated on behalf of the Held Call over any part of a path which is in the establishment phase of a third call ie before the third call's NAM.

3.4.7.3 Call Release After Alternative Routing

If a call that has been alternatively routed by a Transit PBX fails and the Rejection Cause or Clearing Cause received in the RRM or CRM indicates that an end destination has not been reached (eg ROS) then, depending on PBX design, the Transit PBX that initiated alternative routing shall:

- attempt a further alternative route, or
- return an RRM generated from the received RRM or CRM as for normal clearing, or
- return an RRM generated from any RRM or CRM previously returned on the primary route or other alternative routes, in order to reflect back to the previous PBX the condition of one of the other routes rather than the condition of the last tried route.

This allows a PBX to select the most appropriate reason for call failure to return towards the Originating PBX.

If the Rejection Cause or Clearing Cause received on an alternative route implies that the end destination has been reached (eg Busy) then the RRM or CRM received on the alternative route shall be used to generate a RRM which is sent back towards the Originating PBX, irrespective of the contents of any RRM or CRM received on any other route.

3.4.7.4 Clearing of a Channel in Dual Use

If a Controlling PBX receives a CRM on a channel in dual use the channel is released as described in paragraph 3.2.

If a Branching PBX receives a CRM on a channel in dual use the channel is released as described in paragraph 3.2 and clearing is initiated on the held and connected channels.

3.5 MANUFACTURER SPECIFIC SIGNALLING

DPNSS 1 provides means by which manufacturers can define their own extensions to the signalling system. SECTION 15 defines a mechanism whereby manufacturer specific signalling may be added to messages that can contain other DPNSS 1 signalling. SECTION 49 defines a mechanism whereby a message dedicated to carrying only manufacturer specific signalling may be used.

3.6 VIRTUAL CALLS

Supplementary Service requests and information transfers that do not require a traffic channel (eg Call Back When Free Request) are made by means of a Virtual Call.

Virtual Calls are established and cleared down in the same way as "Real Calls". The method by which an indication is given that a message is related to a Virtual Channel is dependent on the Layer 2 variant in use, see SECTION 3 of this specification.

NOTE: THE ABILITY TO HANDLE VIRTUAL CALLS IS A MANDATORY PART OF DPNSS 1.

3.7 CALL COLLISION

3.7.1 ISRMs Cross on a Channel

In DPNSS 1 it is possible for the PBXs at both ends of a channel to simultaneously request a call.

To resolve this collision, the ends of each channel are designated X and Y. The designation is assigned at network configuration by agreement between the parties concerned.

If a DPNSS 1 channel is simultaneously selected for an outgoing call by the PBXs at each end; both will send an ISRM and consequently receive an ISRM in response.

A PBX that has already received an ISRM from a channel shall not select that channel for an outgoing call until the incoming call has cleared.

When ISRMs cross on a channel this shall be resolved as follows:

PBX X shall ignore and discard the incoming ISRM and continue the outgoing call.

PBX Y shall accept the incoming ISRM as a new incoming call. It shall take one of the following actions for the outgoing call:

- Attempt to progress the call by selecting a new channel on the same route.
- Attempt to progress the call by selecting a channel on an alternative route.
- Clear the call backwards with a CRM containing CC:CON.

3.7.2 RMs Cross on a Channel

In DPNSS 1 it is possible for the PBXs at both ends of a channel to simultaneously request a Supplementary Service requiring a shared channel. To resolve this collision, the ends of each channel are designated X and Y. The designation is assigned at network configuration by agreement between the parties concerned.

If both parties request a shared channel during the speech phase of a call both will send an RM. Within a DPNSS 1 Network a channel must not be used by more than two calls as a result of RMs being sent in each direction.

A Branching PBX that has already received an RM from a channel shall not send an RM along that channel until the channel has returned to single use.

The case when RMs cross on a channel shall be resolved as follows:

- PBX "X" shall ignore and discard the incoming RM and continue the outgoing Supplementary Service.
- PBX "Y" shall accept the incoming RM , select a new DPNSS 1 Channel and send an ISRM with the contents of the previously sent RM.

PBX Y thus performs two Branching functions simultaneously.

3.7.3 ERMs Cross on a Channel

Since ERMs operate on an end to end basis the X/Y designations cannot reliably be used to resolve the clash. Under these circumstances both PBXs, having sent an ERM, shall reject the received ERM by returning an RRM containing Rejection Cause: STU.

3.7.4 ERM Crosses With an RM

If an ERM crosses with an RM the resultant clash shall be resolved at the End PBXs as follows;

- A PBX that has originated an RM and is awaiting a response shall reject the incoming ERM with an RRM containing Rejection Cause: STU.
- A PBX that has originated an ERM and is awaiting a response shall accept and process the incoming RM and abandon the ERM call. An RRM will be expected on the abandoned call.

A Branching PBX that has already received an RM from a channel shall not send an ERM along that channel until the channel has returned to single use.

A Branching PBX that has already received an ERM from a channel shall not send an RM along that channel until the channel has returned to single use.

4 CALL CONTROL ERROR HANDLING PROCEDURES

4.1 REACTION TO UNRECOGNISED MESSAGES

4.1.1 General

A message is unrecognised if it:

- is not specified in the issue of the specification to which the PBX conforms.
- is not supported by the PBX under the terms of the Compliance Statement in SECTION 4, Subsection 6.
- is recognised but violates the rules of message sequencing as described in SECTION 4, Subsection 2.

The action of a PBX on receipt of an unrecognised message depends upon:

- The state in which the message is received.
- The message group to which the unrecognised message belongs.
- Whether the PBX is performing a Transit, End or Branching function.

Paragraphs 4.1.2 to 4.1.8 describe the action to be taken based on the state in which the message has been received. In the case where the unrecognised message is an ISRM, however, the alternative action specified in paragraph 4.1.9 may be taken instead. The situations (if any) under which this alternative action is taken are PBX dependent.

4.1.2 Idle State

When a PBX receives any unrecognised message and the channel is IDLE it shall bar the use of the channel for outgoing calls, respond with a CRM containing Clearing Cause: MNU and start a time-out of 4 ± 1 s. On expiry of the time-out the channel shall return to idle.

The receipt of any message, except an ISRM, during the time-out period shall be ignored. The receipt of an ISRM shall stop the time-out and be accepted as an incoming call request.

4.1.3 During Determination of PBX Function

In this state the PBX has not yet received sufficient Destination Address digits in an ISRM - SSRM sequence to determine whether it is to perform a Transit or an End Function.

4.1.3.1 Link-by-Link Group

Any Link-by-Link message other than a Link-by-Link Reject Message (LLRM) that is received shall be rejected by sending a LLRM containing Rejection Cause: Message Not Understood (RC:MNU).

If a LLRM is received in this state it shall be ignored and discarded.

4.1.3.2 Non-Link-by-Link Group

If a PBX receives an unrecognised message that is not in the Link-by-Link Group then the message shall be ignored and discarded.

4.1.4 PBX Function Determined but Routing Incomplete

In this state the PBX has determined its function but a NAM has not yet been signalled.

4.1.4.1 Link-by-Link Group

Any Link-by-Link message other than an LLRM that is received shall, regardless of PBX function, be rejected by sending a LLRM containing Rejection Cause: Message Not Understood (RC:MNU).

If a LLRM is received in this state it shall be ignored and discarded.

4.1.4.2 Non-Link-by-Link Group

4.1.4.2.1 Transit Function

If a Transit PBX receives an unrecognised message in the backward direction that is not in the Link-by-Link Group then the message shall be repeated back to the preceding PBX.

If a Transit PBX receives an unrecognised message in the forward direction that is not in the Link-by-Link Group then the message shall, as a PBX option, either be repeated to the next PBX or be ignored and discarded.

4.1.4.2.1 End Function

If an End PBX receives an unrecognised message that is not in the Link-by-Link Group then the message shall be ignored and discarded.

4.1.5 During an EEM Sequence

In this state the PBX is buffering EEM(I)s and awaiting the remainder of the EEM sequence.

Receipt of a message other than an EEM indicates an error condition and shall be handled in the following way.

If the message is a CRM, the EEMs received so far shall be discarded and the CRM processed in the normal manner.

If the message is not a CRM, then depending upon PBX design, one of the following options shall be taken:

- The received message shall be considered as unrecognised and the EEMs shall be considered still valid. The PBX shall continue to await the remainder of the EEM sequence;
- The EEMs so far received shall be considered as complete but syntactically incorrect and the received message shall then be processed as if the EEM sequence had not been received;
- The received message shall be processed as if the EEM sequence had not been received and the EEMs shall be considered as still valid. The PBX shall continue to await the remainder of the EEM sequence;
- The received message shall be considered unrecognised and the EEMs so far received shall be considered to be complete but syntactically incorrect.

If the EEM sequence is considered to be syntactically incorrect, then;

- at a Transit PBX the EEMs received so far shall be passed on;
- at an End or Branching PBX the EEMs received so far shall be discarded and an EEM containing SNU with Parameter E returned.

If the received message is to be considered unrecognised then it shall be handled as described in paragraph 4.1.8.

4.1.6 During an LLM Sequence

In this state the PBX is buffering LLM(I)s and awaiting the remainder of the LLM sequence.

Receipt of a message other than an LLM indicates an error condition and shall be handled in the following way.

If the message is a CRM, the LLMs received so far shall be discarded and the CRM shall be processed in the normal manner.

If the message is not a CRM, then depending upon PBX design, one of the following options shall be taken:

- The received message shall be considered as unrecognised and the LLMs shall be considered still valid. The PBX shall continue to await the remainder of the LLM sequence;
- The LLMs so far received shall be considered as complete but syntactically incorrect and the received message shall then be processed as if the LLM sequence had not been received;
- The received message shall be processed as if the LLM sequence had not been received and the LLMs shall be considered as still valid. The PBX shall continue to await the remainder of the LLM sequence;
- The received message shall be considered Unrecognised and the LLMs so far received shall be considered to be complete but syntactically incorrect.

If the LLM sequence is considered to be syntactically incorrect the PBX shall discard the LLMs received so far and respond with an LLM containing SNU with Parameter E.

If the received message is to be considered unrecognised then it shall be handled as described in paragraph 4.1.8.

4.1.7 During Channel Release

In this state the PBX is awaiting a CIM having sent a CRM. Any message other than a CIM or CRM shall be ignored and discarded.

4.1.8 All other PBX States

4.1.8.1 Link-by-Link Group

Any unrecognised Link-by-Link message that is received shall be rejected by sending a Link-by-Link Reject Message (LLRM) containing Rejection Cause: Message Not Understood (RC:MNU).

4.1.8.2 Non Link-by-Link Group

4.1.8.2.1 Transit Function

If a Transit PBX receives an unrecognised message, in either the forward or backward direction, that is not in

the Link-by-Link Group then the message shall be repeated to the next PBX.

4.1.8.2.2 Branching Function

If a Branching PBX receives an unrecognised message that is not in the Link-by-Link Group, on any of the three channels, it shall be ignored and discarded.

4.1.8.2.3 End Function

If an End PBX receives an unrecognised or invalid message that is not in the Link-by-Link Group then the message shall be ignored and discarded.

4.1.9 Alternative action for receipt of an unrecognised ISRM

As an alternative to the action described in paragraphs 4.1.3 to 4.1.8, if the unrecognised message is an ISRM (unrecognised by virtue of the state in which it is received), this may be taken as an indication that the call states at the two ends of the link have got out of step. In such a case, the channel may be removed from its current call and the new call which the PBX at the other end of the link is trying to establish cleared, thus ensuring that the channel is returned to the same (idle) state at both ends.

This shall be achieved by:

- a) initiating release of the channel by sending a CRM containing Clearing Cause: NT in response to the ISRM, and;
- b) removing the channel from its current call by taking the same action that would have been taken had a CRM containing Clearing Cause: NT been received instead of the ISRM, except that no CIM shall be sent.

4.2 REACTION TO AN INCOMPLETE OR OVERSIZE MESSAGE SEQUENCE

4.2.1 General

Within DPNSS 1, ISRMs, RMs, ERMs, EEMs and LLMs may be sent as a segmented sequence of messages.

On receipt of a segmented message sequence any PBX that needs to act on the sequence must buffer the message contents until it has received sufficient information to commence processing.

During buffering a PBX shall treat sequences that fail to complete or that exceed the available buffer size as described in 4.2.2 and 4.2.3 below.

4.2.2 Incomplete Message Sequence

A PBX shall run a time-out while buffering in order to detect an incomplete message sequence.

The buffering arrangements and the action to be taken on expiry of the time-out differs depending on the PBX function and the message type and are given below:

4.2.2.1 An EEM Sequence

On receipt of an EEM(I) the message shall be buffered and a timer shall be started. Further EEM(I)s received before the timer expires shall be added to the buffer and the timer shall be restarted. If an EEM(C) is received it shall be added to the buffer, the timer shall be stopped and the buffer contents (ie the entire sequence) shall be processed as if all the supplementary information had been contained in a single EEM(C).

If the timer expires, then at a Transit PBX the messages received so far shall be passed on using EEM(I)s. At an End or Branching PBX the sequence of messages received so far shall be discarded and an EEM containing SNU with Parameter E returned, thus indicating that a syntax error has occurred. The next received EEM(I) or EEM(C) shall be treated as a new EEM message sequence.

The value of the timer is PBX dependent.

4.2.2.2 An LLM Sequence

On receipt of an LLM(I) the message shall be buffered and a timer shall be started. Further LLM(I)s received before the timer expires shall be added to the buffer and the timer shall be restarted. If an LLM(C) is received it shall be added to the buffer, the timer shall be stopped and the buffer contents (ie the entire sequence) shall be processed as if all the supplementary information had been contained in a single LLM(C).

If the timer expires, then at all PBXs the sequence of messages so far received shall be discarded and an LLM containing SNU with Parameter E returned, thus indicating that a syntax error has occurred. The next received LLM(I) or LLM(C) shall be treated as a new LLM message sequence.

The value of the timer is PBX dependent.

4.2.2.3 An ISRM/SSRM Sequence

On receipt of an ISRM(I) with insufficient Destination Address digits to determine routing, the message shall be buffered and a timer shall be started. SSRM(I)s received before the timer expires shall be added to the buffer and the timer shall be restarted. If an SSRM(I) or an SSRM(C) is received containing sufficient Destination Address digits to enable either an extension or an outgoing route to be identified it shall be added to the buffer, the timer shall be stopped and the buffer contents (ie the entire sequence received so far) shall be processed as if all the supplementary information had been contained in a single ISRM.

If the timer expires, then the PBX shall clear the call by sending a CRM containing Clearing Cause: Address Incomplete (CC:AI).

The value of the timer is PBX dependent.

4.2.2.4 An RM/SSRM or ERM/SSRM Sequence

On receipt of an RM(I) [or ERM(I) at an End PBX] with insufficient Destination Address digits to determine routing, the message shall be buffered and a timer shall be started. SSRM(I)s received before the timer expires shall be added to the buffer and the timer shall be restarted. If an SSRM(C) or an SSRM(I) is received containing sufficient Destination Address digits to enable either an extension or outgoing route to be identified, it shall be added to the buffer, the timer shall be stopped and the buffer contents (ie the entire sequence received so far) shall be processed as if all the supplementary information had been contained in a single RM or ERM.

If the timer expires, then the PBX shall clear the new call by sending a RRM containing Clearing Cause: Address Incomplete (CC:AI).

The value of the timer is PBX dependent.

4.2.3 Message Sequence Exceeds Buffer Size

4.2.3.1 An EEM Sequence

If on receipt of an EEM(I) or EEM(C) it is found that the supplementary information it contains cannot be added to the EEM buffer, then a Transit PBX shall pass on the contents of the buffer and then, either buffer the received message or pass this on too. An End or Branching PBX shall respond with an EEM(C) containing SNU with Parameter "F" and discard the contents of the EEM buffer. The new message shall either be discarded or processed as the start of a new EEM sequence.

The buffer size at End PBXs and Branching PBXs shall be at least 135 octets.

4.2.3.2 An LLM Sequence

If on receipt of an LLM(I) or LLM(C) it is found that the supplementary information it contains cannot be added to the LLM buffer then the PBX shall respond with an LLM(C) containing SNU with Parameter "F" and discard the contents of the LLM buffer. The new message shall be either discarded or processed as the start of a new LLM sequence.

The buffer size at End PBXs and Branching PBXs shall be at least 135 octets.

4.2.3.3 An ISRM/SSRM Sequence

If on receipt of an SSRM it is found that the buffer cannot accommodate it, and the PBX has insufficient digits to determine routing, then the messages so far received shall be rejected by sending a CRM containing Clearing Cause: SNU and Supplementary Information String SNU with Parameter "F".

The buffer size at all PBXs shall be at least 135 octets.

4.2.3.4 RM/SSRM or ERM/SSRM Sequence

If on receipt of an SSRM it is found that the buffer cannot accommodate it, and the PBX has insufficient digits to determine routing, then the messages so far received shall be rejected by sending a RRM containing Rejection Cause: SNU and Supplementary Information String SNU with Parameter "F".

The buffer size at all PBXs shall be at least 135 octets.

4.3 REACTION TO UNRECOGNISED SUPPLEMENTARY INFORMATION STRINGS

4.3.1 General

A Supplementary Information String is unrecognised if it cannot be acted upon by a PBX for any of the following reasons:

- it is undefined in this specification (but see Note 1 below);
- it is for a service not supported by the PBX (but see Note 2 below);
- it is an invalid use of the String, eg in the wrong message;
- it is unexpected in the context in which it is received, eg it is additional to the message contents defined for the state the receiving PBX is in;
- it is a String used at the wrong time in a call;
- it is a String used in the wrong type of call;
- it contradicts a previous String in the same Selection or Indication Block;
- it duplicates a previous String, other than NSI, in the same Selection or Indication Block (even if the Parameters differ);
- it is an inappropriate String in a Virtual Call;
- it is an inappropriate String in a Real Call;
- it has a missing Parameter;
- it contains a normally expected Parameter but with unrecognised contents (see Note 3 below);
- it is an NSI String where the NSI Identifier Parameter indicates that the String is for a manufacturer-defined service which is not supported.

NOTE 1: New Strings may be allocated by prior agreement of the DPNSS 1 Working Party in advance of a new service being published. Under these circumstances a PBX may recognise a String not appearing in this specification.

NOTE 2: Where a PBX does not support a given Supplementary Service there are some circumstances where a better grade of service for the network as a whole would result if the PBX were to recognise and act upon some of the Strings used within the service.

Where permitted, the recognition and resultant action to be taken on receipt of such Strings is indicated in the relevant Section of this specification.

Such actions may be sanctioned by prior agreement of the DPNSS 1 Working Party in advance of additional text being published in the specification.

NOTE 3: If the Parameter is a SIC it need not be checked at a Transit PBX if the outgoing channel characteristics can be matched to those of the incoming channel.

PBX action on receipt of an unrecognised Supplementary Information String will depend on:

- the message containing the unrecognised Supplementary Information String;
- whether the PBX is required to provide Transit, Branching or End functions. In the case of an ISRM or RM this is determined by the Destination Address;
- whether the unrecognised Supplementary Information String is Mandatory, Optional or Informative, as determined by the Identifier Suffix received.

The Identifier Suffix is used by a PBX to determine how to react to a Supplementary Information String when it is unrecognised. Specific actions on receipt of unrecognised Strings are detailed in the following paragraphs.

In general the suffices are used as follows:

- An Informative suffix is used where it is not essential that the receiving PBX understands the String.
- An Optional suffix is used where it is not essential that the receiving PBX understands the String but the sending PBX requires to be notified if the String is unrecognised and has therefore been ignored.
- A Mandatory suffix is used where it is essential that the receiving PBX understands the String for the successful processing of the message.

The status of an unrecognised String is determined with respect to the receiving PBX(s) function and is indicated by the alphabetic suffix as shown in TABLE 1.

TABLE 1

DETERMINATION OF INFORMATION STRING STATUS		
PBX FUNCTION	SUPPLEMENTARY INFORMATION STRING IDENTIFIER SUFFIX	STATUS
TRANSIT	NO SUFFIX OR ABCDEFGH	INFORMATIVE
	IJKLMNOPQ	OPTIONAL
	RSTUVWXYZ	MANDATORY
BRANCHING	NO SUFFIX OR ABIJKRST	INFORMATIVE
	CDELMNUVW	OPTIONAL
	FGHOPQXYZ	MANDATORY
END	NO SUFFIX OR CFILORUX	INFORMATIVE
	ADGJMPSVY	OPTIONAL
	BEHKNQTWZ	MANDATORY

When a PBX is providing more than one function on a call, eg Branching and Transit, and reference to TABLE 1 shows a String to have a different status for each, then only the more Stringent shall apply.

If more than one unrecognised String is received in a message the action taken shall be for the String(s) with the most Stringent status.

If more than one unrecognised Mandatory String is received in a message the PBX action is based on only one of the Strings, the others being ignored. The choice of which String to act upon is dependent on PBX design.

If more than one unrecognised Optional String is received in a message then the action taken shall be the same as that for one String, except that the identifiers of all of the ignored Strings shall be returned in the Parameter of the IG-SNU String. Each identifier shall be separated in the Parameter by single space characters.

Where a recognised Supplementary Information String contains additional Parameter(s) to those recognised by the recipient PBX they may be ignored regardless of the suffix of the String itself. However, a Transit PBX shall pass on the complete String including the unrecognised Parameter(s).

In addition it is possible that a message containing IG-SNU may be followed by further messages containing IG-SNU or SNU if further unrecognised Strings are subsequently detected or SNU(M) if a String is subsequently found to be missing.

4.3.2 INITIAL SERVICE REQUEST Messages ISRM(C) or ISRM(I) plus SSRMs

If the unrecognised String is in an ISRM the PBX must first analyse sufficient of the Destination Address to determine whether a Transit or End function is required (see TABLE 2). The PBX can then determine if the String is Mandatory, Optional or Informative for that function by reference to the Identifier Suffix (See TABLE 1).

TABLE 2

ANALYSIS OF DESTINATION ADDRESS IN AN ISRM TO DETERMINE PBX FUNCTION			
	DESTINATION AS INDICATED BY THE "DA" IN THE ISRM		
	OUTGOING DPNSS 1 CHANNEL	ON-PBX EXTENSION	OUTGOING CALL TO OTHER SIG SYSTEM
PBX FUNCTION	TRANSIT	END	END

If a PBX determines that the unrecognised String is Mandatory it shall release the call by sending a CRM. The CRM shall contain a Clearing Cause SNU plus a Supplementary Information String SNU. A CIM shall be expected in response.

If the unrecognised String is Optional the PBX shall ignore it and shall:

- process the call in accordance with the remainder of the message;
- notify the Originating PBX that the String has been ignored by sending a NIM containing IG-SNU;
- if a Transit function is being provided, repeat the String in an ISRM to the next PBX.

If the unrecognised String is Informative the PBX handles it in the same way as an Optional String except that it does not notify the Originating PBX with a NIM.

4.3.3 RECALL Message RM(C) or RM(I) Plus SSRMs or END-TO-END RECALL Message ERM(C) or ERM(I) plus SSRMs.

If the unrecognised String is in an RM the PBX must first analyse sufficient of the Destination Address to determine which of the Transit, Branching and End functions are required (see TABLE 3). At an End PBX an ERM shall be treated as if it were an RM. The PBX can then determine if the String is Mandatory, Optional or Informative by reference to the identifier suffix (see TABLE 1). ERMs are repeated by Transit PBXs without the Strings being analysed (see also paragraph 3.4.1).

TABLE 3

ANALYSIS OF DESTINATION ADDRESS IN A RM OR ERM TO DETERMINE PBX FUNCTION(S)					
	DESTINATION AS INDICATED BY THE 'DA' IN AN RM OR ERM				
	VIA EXISTING CHANNEL		VIA NEW CHANNEL		ON PBX EXTENSION
	OUTGOING DPNSS 1 CHANNEL	OTHER SIGNALLING SYSTEM	OUTGOING DPNSS 1 CHANNEL	OTHER SIGNALLING SYSTEM	
FUNCTION(S) REQUIRED FROM PBX	TRANSIT	END	BRANCHING + TRANSIT	BRANCHING + END	BRANCHING + END

If, based on the required function(s), the PBX determines that the unrecognised String is Mandatory it shall maintain the channel and return an RRM. The RRM shall contain Clearing Cause: SNU plus a Supplementary Information String RR-SNU. The Parameter of the RR-SNU String will contain the identifier of the unrecognised String.

If the String is Optional, the PBX shall ignore it and it shall:

- process the call in accordance with the remainder of the message.
- notify the requesting PBX that the String has been ignored by sending a NIM containing IG-SNU.
- if a Transit function is being provided, repeat the String to the next PBX in either an RM, ERM or an ISRM.

If the String is Informative the PBX handles it in the same way as an Optional String except that it does not notify the new call's Originating PBX with a NIM.

4.3.4 NUMBER ACKNOWLEDGE Message (NAM)

4.3.4.1 Transit Function

All Supplementary Information Strings in a NAM are ignored by a Transit Function but must be included in the NAM that is repeated to the preceding PBX.

4.3.4.2 Branching Function

If the unrecognised String is Mandatory the PBX shall:

- discard the message.
- release the new outgoing call by sending a CRM. The CRM shall contain Clearing Cause: SNU plus a Supplementary Information String SNU. A CIM shall be expected in response.
- send an RRM containing a Rejection Cause: NT to the new call's Originating PBX. This requirement is not applicable when the Branching Function is provided at the new call's Originating PBX.

If the String is Optional the PBX shall ignore it, and shall:

- process the call in accordance with the remainder of the message.
- notify the new call's Terminating PBX by sending an EEM containing IG-SNU.
- include the String in the NAM which is sent to the preceding PBX, unless the Branching Function is provided at the new call's Originating PBX.

If the String is Informative the PBX shall handle it in the same way as an Optional String except that it shall not notify the new call's Terminating PBX.

4.3.4.3 End Function

If the unrecognised String is Mandatory the PBX shall discard the message and release the outgoing call by sending either a CRM or an SCRIM. The CRM shall contain a Clearing Cause: SNU plus a Supplementary Information String SNU. The SCRIM shall contain Clearing Cause: SNU plus Supplementary Information Strings SNU and COC. A CIM or SCIM shall be expected in response.

If the String is Optional the PBX shall ignore it and shall notify the Terminating PBX by sending an EEM containing IG-SNU and, if via a shared channel, COC. The call shall proceed in accordance with the remainder of the message.

If the String is Informative the PBX shall ignore it and shall not notify the Terminating PBX.

4.3.5 END-TO-END Message EEM(C)/Sequence of EEM(I)s & EEM(C)

4.3.5.1 Transit Function

All Supplementary Information Strings in an EEM are ignored by a Transit Function but must be included in the EEM that is repeated on to the next PBX.

4.3.5.2 Branching Function

An EEM may be received on any of the three channels associated with the call.

If the unrecognised String in the EEM is Mandatory the PBX shall discard the message, maintain the existing call state and respond with an EEM containing SNU. The EEM shall include COC if the received EEM was from a shared channel and contained COC.

If the String in the EEM is Optional the PBX shall ignore it and:

- process the call in accordance with the remainder of the message;
- notify the requesting PBX by sending IG-SNU in an EEM. The EEM shall include COC if the received EEM was from a shared channel and contained COC;
- repeat the EEM including the unrecognised String to the next PBX unless:
 - a) the Branching function is provided at the new call's Originating PBX, or
 - b) a String within the EEM indicates that it is for the Branching PBX.

The channel on which the message is repeated depends on the service concerned.

If the EEM to be repeated is received from the connected channel it is sent to the shared channel with the String COC added.

If the EEM to be repeated is received from the shared channel and it contains COC it shall be sent to the connected channel but the COC String shall be removed. Otherwise it shall be sent to the held channel.

If the unrecognised String is Informative it shall be handled in the same way as an Optional String except that no EEM shall be returned.

4.3.5.3 End Function

If the String is Mandatory the PBX shall discard the message maintain the existing call state and respond with an EEM containing SNU.

If the String is Optional the PBX shall ignore it and notify the Requesting PBX by sending a EEM containing IG-SNU. The call will proceed in accordance with the remainder of the message.

If the String is Informative it shall be handled in the same way as an Optional String except that no EEM is sent.

4.3.6 CALL CONNECTED Message (CCM)

4.3.6.1 Transit Function

All Supplementary Information Strings in a CCM are ignored by a Transit Function but must be included in the CCM that is repeated to the next PBX.

4.3.6.2 Branching Function

A CCM may be received on any of the three channels associated with the call.

NOTE: A CCM can occur during certain Supplementary Services if one of the parties attempts to clear at an incorrect point in the call and is automatically rung back.

If the unrecognised String is Mandatory the PBX shall act upon the CCM itself but discard all Supplementary Information Strings and respond with an EEM containing SNU. The EEM shall include COC if the received CCM was from the shared channel and contained COC. The CCM shall be passed on but all Supplementary Information Strings shall be discarded.

If the String is Optional the PBX shall ignore it and shall:

- process the call in accordance with the remainder of the message;

- notify the requesting PBX by sending IG-SNU in an EEM. The EEM shall include COC if the CCM was received on a shared channel and contained COC;
- repeat the CCM including the unrecognised String to the next PBX.

The channel on which the message is repeated depends on the service concerned.

If the CCM to be repeated is received from the connected channel it is sent to the shared channel with the String COC added.

If the CCM to be repeated is received from the shared channel and it contain COC it shall be sent to the Connected Channel but the COC String shall be removed. otherwise it shall be sent to the Held Channel.

If the String is Informative it shall be handled in the same way as an Optional String except that no EEM shall be returned.

4.3.6.3 End Function

If the String is Mandatory the PBX shall act normally upon the CCM, discard all of the Supplementary Information Strings and respond with an EEM containing SNU. The EEM shall include COC if the received CCM was from a shared channel and contained COC.

If the String is Optional the PBX shall ignore it and notify the Requesting PBX by sending an EEM containing IG-SNU. The EEM shall include COC if the received CCM was from the shared channel and contained COC. The call will proceed in accordance with the remainder of the message.

If the String is Informative it shall be handled in the same way as an Optional String except that no EEM is sent.

4.3.7 NETWORK INDICATION Message (NIM)

4.3.7.1 Transit Function

All Supplementary Information Strings in NIMs are ignored by a Transit function but must be included in the NIM that is repeated to the next PBX.

4.3.7.2 Branching Function

If the String is Mandatory the PBX shall:

- discard the message;

- release the new outgoing call by sending a CRM. The CRM shall contain Clearing Cause: SNU plus a Supplementary Information String SNU. A CIM shall be expected in response;
- send a RRM containing Rejection Cause: NT to the new call's Originating PBX. This requirement is not applicable when the Branching Function is provided at the new call's Originating PBX.

If the String is Optional or Informative the PBX shall ignore and shall:

- process the call in accordance with the remainder of the message;
- repeat the String to the preceding PBX unless the Branching Function is provided at the new call's Originating PBX.

No message is sent to notify the new call's Terminating PBX.

4.3.7.3 End Function

If the String is Mandatory the PBX shall discard the message and release the outgoing call by sending a CRM unless the new call is using a shared channel in which case an SCRM is sent. The CRM shall contain a Clearing Cause: SNU plus a Supplementary Information String SNU. The SCRM shall contain Clearing Cause: SNU plus Supplementary Information Strings SNU and COC. A CIM or a SCIM is expected in response.

If the String is Optional or Informative the PBX shall ignore it and not notify the new call's Terminating PBX.

4.3.8 CLEAR REQUEST Message (CRM), RECALL REJECT Message (RRM), LINK-BY-LINK REJECT Message (LLRM) and SINGLE CHANNEL CLEAR REQUEST Message (SCRM)

If a CRM, RRM, LLRM or SCRM contains an unrecognised Supplementary Information String, the clearing sequence shall be unaffected and the message shall be treated in accordance with the Clearing Cause. In the case of Transit and Branching Transit PBXs the String shall be repeated in the CRM, RRM, LLRM or SCRM that is sent on the next link.

4.3.9 CLEAR INDICATION Message (CIM) and SINGLE CHANNEL CLEAR INDICATION Message (SCIM)

If a CIM or SCIM contains an unrecognised Supplementary Information String the clearing sequence shall be unaffected.

4.3.10 LINK-BY-LINK Message LLM(C) or Sequence of LLM(I)s Plus LLM(C)

Transit, Branching or End Function

If the unrecognised String is Mandatory the PBX shall maintain the existing call state and respond with an LLM containing SNU.

If the String is Optional the PBX shall ignore it and shall:

- process the call in accordance with the remainder of the message;
- notify the Requesting PBX by sending IG-SNU in an LLM;
- repeat the LLM including the unrecognised String to the next PBX unless:
 - a) an End function has been reached;
 - b) a String within the LLM indicates that it is not to be repeated;

If the String is Informative it shall be handled in the same way as an Optional String except that no LLM shall be returned.

4.3.11 SWAP Message (SM)

Transit, Branching or End Function

If the unrecognised String is Mandatory the PBX shall discard the message, maintain the existing call state and respond with a SM containing String SNU and the SIC currently in use.

If the String is Optional the PBX shall ignore it and shall:

- Process the call in accordance with the remainder of the message,
- notify the Requesting PBX by sending IG-SNU in an LLM,
- repeat the SM including the unrecognised String to the next PBX.

If the String is Informative it shall be handled in the same way as an Optional String except that no LLM shall be returned.

4.4 REACTION TO MISSING STRINGS

Where a PBX determines that a Supplementary Information String which should be present in a Selection or Indication Block is missing, the PBX shall either:

a) ignore the omission and continue processing the message,

or

b) take the same action as for the receipt of an unrecognised String with a Mandatory suffix, except that the SNU or RR-SNU Parameter shall be the IA5 character "M".

The String shall not be treated as missing if its inclusion in a message is defined as being optional in the context in which the message is received.

NOTE: In this case the term "optional" refers to whether it is specified that the sending PBX shall include the String in a message; the term does not relate to the String status "Optional" as determined from its Identifier Code Suffix (as in TABLE 1, paragraph 4.3 of this Section).

4.5 REACTION TO AN UNRECOGNISED SERVICE INDICATOR CODE (SIC)

A SIC in the SIC Field of an ISRM, RM, ERM or SM may be unrecognised if it is:

- specified as invalid in SECTION 4 of the issue of this specification to which the PBX conforms;
- not supported by the PBX in that the SIC is not compatible with any of the PBX's terminals or routes.

At a Transit PBX where the outgoing channel characteristics can be matched to the incoming channel characteristics, any SIC may be considered as recognised and passed on without checking.

Where a SIC is determined as being unrecognised, then depending on PBX design, it shall be handled as described in either paragraph 4.5.1 or 4.5.2 below:

4.5.1 An unrecognised SIC shall be treated in the same way as a recognised SIC which is incompatible with either the route(s) available or with the called terminal. Procedures for rejecting a call or Swap Request on the basis of an incompatible SIC are specified in later Sections of this specification.

4.5.2 An unrecognised SIC shall be rejected as follows;

- On receipt of an unrecognised SIC in an SM a PBX shall discard the message, maintain the existing call state and respond with an SM containing the SIC received and String SNU. The Parameter of the SNU String shall be the IA5 character S.
- On receipt of an unrecognised SIC in an ISRM, RM or ERM a PBX shall return a CRM or RRM as appropriate with a Clearing/Rejection Cause: SNU plus a Supplementary Information String SNU or RR-SNU. The Parameter of the SNU String shall be the IA5 character S.

4.6 REACTION TO AN UNRECOGNISED OR MISSING CLEARING CAUSE

If a CRM, CIM, SCRM, SCIM, RRM or LLRM is received with an unrecognised or missing Clearing/Rejection Cause, the clearing/rejection sequence shall be treated as if the Clearing/Rejection Cause was Network Termination (NT).

However, in the case of a CRM, or SCRM, the responding CIM or SCIM shall contain an exact copy of the contents of the CRM or SCRM.

At a Transit PBX these messages shall be passed on unchanged.

4.7 REACTION TO MESSAGE WITH SYNTAX ERROR

A message has a Syntax Error if it does not obey the rules for message structure; for example if it has:

- insufficient octets;
- no * at the start of a String;
- no * or # after the identifier/suffix;
- no # at the end of a String;
- Invalid character(s) in the Destination Address;
- a Non Numeric String Identifier;

Where, during analysis of Supplementary Information String Parameters, either ** or *# is encountered, this may be treated either as a Syntax Error, or an error which renders the Supplementary Information String unrecognised. The course of action taken is a matter for PBX design. Where the error is treated as causing the Supplementary Information String to be unrecognised, the reaction shall be as described in paragraph 4.3.

With the exception of 4.7.1 and 4.7.2 below the action of a PBX on receipt of a Syntax Error in any valid message shall be as described in paragraph 4.3 for an unrecognised Mandatory String except that the SNU Parameter shall be "E".

4.7.1 An SCRM containing a Syntax Error shall be ignored and discarded.

4.7.2 PBX action on receipt of a valid SSRM after determination of call destination and containing a syntax error shall depend on the PBX function as follows.

End Function

If the PBX function is End then the action shall be as for an unrecognised Mandatory String (see paragraph 4.3.2, except that the SNU Parameter shall be the IA5 character E.

In addition if an outgoing non DPNSS 1 route has already been selected as a result of the Destination Address digits previously received, clearing shall be initiated on that route.

Transit Function

If the function of the PBX is Transit then the action taken depends on whether Single Channel Working is being used on the outgoing channel.

If the outgoing channel is not in dual use, then the SSRM may either be passed on or the PBX may as an option clear the call. If the call is cleared the outgoing channel shall be released by sending a CRM with Clearing Cause: NT and a CIM shall be expected in response. If the SSRM is passed on, then no attempt shall be made by the PBX to reroute the call on any subsequent receipt of a CRM indicating congestion, ie the call shall continue to be cleared backwards.

If the outgoing channel is in dual use then the SSRM must be passed on, ie there is no option of clearing the call on receipt of an SSRM with a Syntax Error whilst acting as a transit for channels in dual use. If congestion is subsequently encountered, then no attempt shall be made to re-route the call and the clearing sequence shall be continued in the normal manner.

NOTE: Since certain Syntax Errors can simulate other types of error condition then, under these conditions, it is permissible for the PBX to respond with other than SNU-E.

In addition some Syntax Errors can simulate legitimate message structures; under these conditions the reaction of the PBX will be dependent on the nature of the simulation.

4.8 REACTION TO NON-RECEIPT OF A RESPONSE DURING END-TO-END SIGNALLING

Action on non-receipt of an expected response to a Supplementary Information String within a NAM, EEM or CCM is normally specified in the Service Sections of this specification.

In cases where this is not covered by the Service Section the following action shall be taken:

The PBX shall start a timer of not less than 5 s to cover non receipt of the expected response (this includes SNU or IG-SNU). Receipt of a response stops the timer. On expiry of the timer the PBX may either:

- Take the same action as for receipt of an EEM containing SNU or IG-SNU depending on whether the suffix of the un-acknowledged String was Mandatory or Optional.

or

- If the un-acknowledged String was sent in an EEM, the sending PBX may repeat the EEM.

In cases where one response sequence may trigger another at a Branching or Conference PBX, an extended time-out value may be used.

5 GENERAL MAINTENANCE SIGNALLING PROCEDURES

5.1 INTRODUCTION

The DPNSS 1 Maintenance signalling procedures are primarily intended to support the Traffic-Channel Maintenance Supplementary Service described in SECTION 27 of this specification.

The DPNSS 1 Link Maintenance features of a PBX are controlled by means of the Link Maintenance Message (LMM) and the Link Maintenance Reject Message (LMRM).

These messages are transported using the normal Level 2 procedures of DPNSS 1. The channel requiring maintenance action is indicated by the Level 2 address field. LMMs and LMRMs are separated from the Call Control messages by the Process Selector function and therefore have no effect on the call control processing. Consequently they can be sent at any time regardless of whether the associated traffic, or Virtual, Channel is Idle or in use.

If a PBX does not support the Traffic Channel Maintenance Supplementary Service, then any LMMs that are received will be handled as unrecognised messages in the Link-by-Link Group as described in paragraph 4.1 of this specification for the current DPNSS 1 Service Process state.

5.2 REACTION TO UNRECOGNISED SUPPLEMENTARY INFORMATION STRINGS IN LINK-MAINTENANCE MESSAGES

5.2.1 General

The action will generally be as described in paragraph 4.3.1 of this Section except that the PBX is always considered to be an End PBX.

5.2.2 Link-Maintenance Message (LMM)

If the unrecognised String is Mandatory, the PBX shall not act on the message and shall respond with an LMRM containing Clearing Cause: SNU and the String SNU.

If the unrecognised String is Optional, the PBX shall ignore it, and shall:

- process the remainder of the message
- notify the Requesting PBX by sending an LMRM containing Clearing Cause: SNU and the String IG-SNU.

If the unrecognised String is Informative, it shall be handled in the same way as an Optional unrecognised String, except that no LMRM shall be returned.

5.2.3 Link Maintenance Reject Message (LMRM)

If an LMRM contains an unrecognised Supplementary Information String, the rejection sequence shall be unaffected and the message shall be treated in accordance with the Rejection Cause.

5.3 REACTION TO MESSAGE WITH UNRECOGNISED MAINTENANCE ACTION

If an LMM is received with an unrecognised maintenance action, the PBX shall not act on the message but shall respond with an LMRM containing Clearing Cause: SNU and the String SNU. The Parameter of the SNU String shall be the IA5 character A.

5.4 REACTION TO MISSING STRINGS

Where a PBX determines that a Supplementary Information String which should be present in a message is missing, the PBX shall either:

- a) ignore the omission and continue processing the message,
- or
- b) take the same action as for the receipt of an unrecognised Mandatory String, except that the Parameter of the SNU String shall be "M".

The String shall not be treated as missing if its inclusion in a message is defined as being optional in the context in which the message is received.

NOTE: In this case the term "optional" refers to whether it is specified that the sending PBX shall include the String in a message; the term does not relate to the String status "Optional" as determined from its Identifier Code Suffix (as in TABLE 1, paragraph 4.3 of this Section).

5.5 REACTION TO AN UNRECOGNISED OR MISSING REJECTION CAUSE

If an LMRM is received with an unrecognised or missing Rejection Cause, the rejection sequence shall be treated as if the Rejection Cause was Network Termination.

5.6 REACTION TO SYNTAX ERROR

If an LMM is received with a Syntax Error it shall be handled as described in paragraph 5.2 for an unrecognised Mandatory String except that the SNU Parameter shall be "E".

6 COMPLIANCE

In general the requirements of SECTION 5 must be provided on PBXs that support DPNSS 1. However, some parts of the Section are optional and these are listed in TABLE 1. Any requirements appearing in the Section that are not included in TABLE 1 shall be taken as mandatory.

Where an optional capability is not supported by a PBX then the PBX shall provide the appropriate rejection procedures in accordance with this Section.

Where a PBX acts as a Transit PBX it shall comply with the Transit (including Virtual Transit) requirements of this Section. In general a Transit PBX is transparent to Supplementary Service signalling, and this is referred to as "Inherent DPNSS 1 Capability" on the Compliance tables within individual Supplementary Service Sections.

The PBX shall conform to the Supplementary Service interactions defined in ANNEX 5 of this Section for those Services that are supported by the PBX.

TABLE 1

COMPLIANCE WITH DPNSS 1 SIGNALLING PROCEDURES		
SERVICE VARIANT		COMMENT
Full Single-Channel Working		
Partial Single-Channel Working		
General Maintenance Procedures		

DIGITAL PRIVATE NETWORK SIGNALLING SYSTEM NO 1 (DPNSS 1)

SECTION 5

**ANNEX 1 : MESSAGE SEQUENCE DIAGRAM (MSD) SYMBOLS USED IN
DPNSS[188], DPNSS[189] AND DPNSS[189-I] LEVEL 3
DESCRIPTIONS**

CONTENTS

1	GENERAL	Page 2
2	MSD SYMBOLS	Page 2

HISTORY

Issue 1 - December 1989

Issue 2 - March 2001 - Specification renamed as DPNSS[188]

1 GENERAL

1.1 Within specifications DPNSS[188], DPNSS[189] and DPNSS[189-I] the Simple Call and Supplementary Services are described with the aid of Message Sequence Diagrams (MSDs).

1.2 Each MSD shows the message flow and message contents for the successful case. Alternative sequences (eg for unsuccessful calls) are detailed in text.

1.3 Reference is made on each MSD to paragraphs in the accompanying text which give details of the actions and responses of the PBX(s) concerned.

1.4 This Annex gives a key to the symbols and conventions used on the MSDs throughout specifications DPNSS[188], DPNSS[189] and DPNSS[189-I].

2 MSD SYMBOLS

2.1 A DPNSS 1 Message

ISRM(I)	-	MESSAGE TYPE
SIC=TELE)	
OLI)	Mnemonic
CLC-ORD)	of Message
DA)	Contents

Coding details for the mnemonics shown in the above message are given in SECTION 4 of this specification.

2.2 Message Flow Related to a Traffic Channel



A message flow related to a Traffic Channel is shown by a solid line.

2.3 Message Flow Related to a Virtual Channel (Virtual Call)



A message flow related to a Virtual Channel is shown by a broken line.

2.4 Reference to Text for Explanation of PBX Action and Possible Alternative Sequences

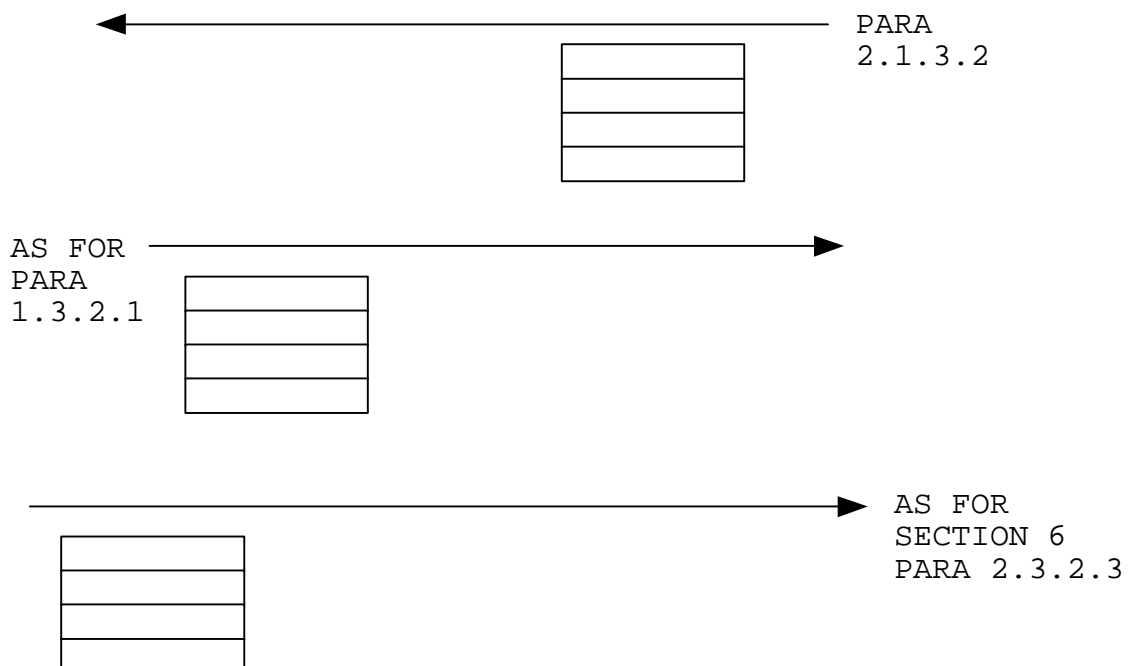

2.5 A Signal or Indication Within a Traffic Channel

AWAITING ANSWER INDICATION

These signals are not conveyed as DPNSS 1 messages within the common signalling channel.

DIGITAL PRIVATE NETWORK SIGNALLING SYSTEM NO 1 (DPNSS 1)

SECTION 5

**ANNEX 2 : SDL SYMBOLS USED IN DPNSS[188] AND DPNSS[189] LEVEL 3
DESCRIPTIONS**

CONTENTS

1	GENERAL	Page 2
2	SDL SYMBOLS	Page 5
3	PBX/CHANNEL CONFIGURATIONS	Page 9

HISTORY

Issue 1 - December 1989

Issue 2 - March 2001 - Specification renamed as DPNSS[188]
- Note added to paragraph 1.1
- Note in paragraph 1.4.1 amended

1 GENERAL

1.1 This Annex details the SDL symbols and conventions used to describe the following Level 3 DPNSS processes;

- DPNSS 1 Channel Process
- DPNSS 1 Service Process
- Maintenance Channel Process
- Maintenance Service Process
- Process Selector

NOTE: In this issue of the specification, DPNSS 1 Service Process SDL is only provided for the Simple Telephony Call and the Circuit Switched Data Call. These are included in SECTION 6 and SECTION 7 respectively.

Other Service Process SDL provided in previous issues of this specification is no longer available.

1.2 A short textual description is given against each SDL symbol in Subsection 2 of this Annex.

1.3 Subsection 3 shows PBX/DPNSS1 Channel configurations. It should be noted that on the SDL diagrams shown in this specification the messages from a DPNSS 1 channel always arrive from the right regardless of the direction of the call or whether the PBX is originating or terminating.

1.4 The following convention is used when representing the passing of information from the Channel Process to the Service Process.

1.4.1 End PBX

At an End PBX the Channel Process passes to the Service Process only those Supplementary Information Strings that are recognised by the PBX (see SECTION 5 Paragraph 4.3).

If the Channel Process determines that none of the Supplementary Strings within a valid message are recognised then an empty message may be shown as being passed to the Service Process.

If an empty message is not explicitly shown in the Service Process SDL diagrams as an input to one of the appearances of the current state then this indicates that the message is assumed for the purposes of SDL to have been discarded.

NOTE: The SDL does not cover all aspects of DPNSS 1. Information not appearing in the SDL will not be discarded by the PBX if its use is described in the text of this specification.

1.4.2 Transit PBX

The Channel Process shall explicitly pass all Messages and Supplementary Information Strings to the Service process with the exception of the following:

- Unrecognised messages in the Link by Link Group
- Unrecognised Supplementary Information Strings that are mandatory at Transit PBXs

The Service Process at a Transit PBX will therefore receive Messages and Supplementary Information Strings that are not explicitly shown in the SDL diagrams or described in text. These messages and strings shall be handled as shown on the Service Process SDL for "OTHER MESSAGE" and "OTHER STRINGS".

1.4.3 Branching Transit PBX

The Channel Process shall explicitly pass all Messages and Supplementary Information Strings to the Service process with the exception of the following:

- Any Unrecognised message
- Unrecognised Supplementary Information Strings that are mandatory at Transit or Branching Transit PBXs

The Service Process at a Branching Transit PBX will therefore receive Messages and Supplementary Information Strings that are not explicitly shown in the SDL diagrams or described in text. These messages and strings shall be handled as shown on the Service Process SDL for "OTHER MESSAGE" and "OTHER STRINGS".

NOTE: "OTHER MESSAGES" will represent messages that are recognised by the PBX but are not applicable to the Supplementary Service concerned.

1.5 Some of the messages shown in the Channel Process SDL are optional, eg SCRMM is only supported if the PBX provides Single Channel Working. These messages shall be handled as "OTHER MESSAGES" if they are not supported by the PBX.

1.6 When making an outgoing call it is assumed within the Service Process that a free channel will be available on the route indicated in any call requests received from other processes.

Therefore at a Transit PBX the incoming Channel Process must have knowledge of the availability of any required outgoing channels before passing an ISRM or RM to the Service Process.

Similar knowledge is assumed for the Extension or PBX processes.



1.7 When passing information from Level 3 to Level 2 it is assumed within the Level 3 SDL that Level 2 is capable of handling all messages presented to it. The procedures for handling failure between Levels 2 and 3 are PBX dependent and not shown in this specification.

1.8 The Service Process will communicate with one or more Channel Processes depending upon the Supplementary Service concerned and the PBX function being provided.

1.9 Where time-outs are given on the SDL diagrams only the nominal time-out value is shown, the tolerance is given in the textual description.

1.10 The SDL diagrams shown in this specification are based on CCITT Recommendations Z.101, Z.102 and Z.104.

2. SDL SYMBOLS USED FOR LEVEL 3 DESCRIPTION IN DPNSS[188] AND DPNSS[189]

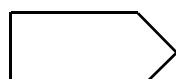
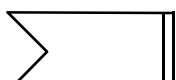
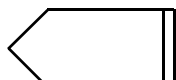
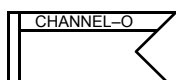
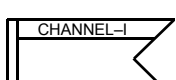
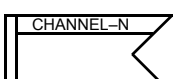
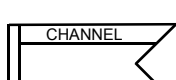
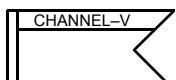
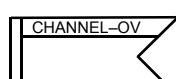
2.1		Either the Channel Process or a Service Process is awaiting instructions. Each state in the Service Process is numbered for cross reference purposes.
2.2		An input from Level 2 of DPNSS 1 to the Channel Process. (via the process selector)
2.3		An output to Level 2 of DPNSS 1 from the Channel Process. (via the process selector)
2.4		An input to the Channel Process from the Service Process, or; An input to the Service Process from the PBX Central Process.
2.5		An output from the Channel Process to the Service Process, or; An output from the Service Process to the PBX Central Process.
2.6		An input to the Service Process from the Channel Process in the outgoing mode at a Transit or Branching Transit PBX. (see Subsection 3 Fig. c & e)
2.7		An input to the Service Process from the Channel Process in the incoming mode at a Transit or Branching Transit PBX. (see Subsection 3 Fig. c & e)
2.8		An input to the Service Process from the Channel Process related to a second call eg Enquiry. (see Subsection 3 Fig. d & e)
2.9		An input to the Service Process from a Channel Process either when only one channel is involved in the call (see Subsection 3 a & b) or, from the Channel Process of the original call when a second call exists. (see Subsection 3 Fig.d)
2.10		An input to the Service Process from a Channel Process of a Virtual Call.
2.11		An input to the Service Process from a Channel Process of a virtual channel in the outgoing mode at a Transit or Branching Transit PBX. (see Subsection 3 Fig. c & e)

2. SDL SYMBOLS USED FOR LEVEL 3 DESCRIPTION IN DPNSS[188] AND DPNSS[189] (continued)

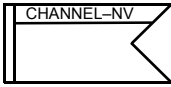
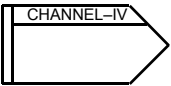
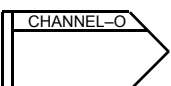
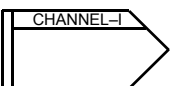
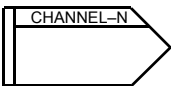
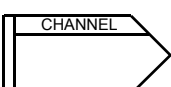
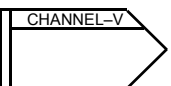
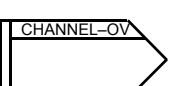
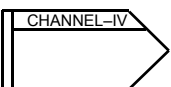
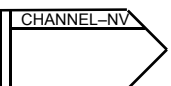
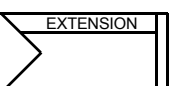
2.12		<p>An input to the Service Process from the Channel Process related to a second Virtual Call e.g. Diversion Follow me Validation. (see Subsection 3 Fig. d)</p>
2.13		<p>An input to the Service Process from the Channel Process of a virtual channel in the incoming mode at a Transit or Branching Transit PBX. (see Subsection 3 Fig. c & e)</p>
2.14		<p>An output from the Service Process to a Channel Process in the outgoing mode at a Transit or Branching Transit PBX. (see Subsection 3 Fig. c & e)</p>
2.15		<p>An output from the Service Process to a Channel Process in the incoming mode at a Transit or Branching Transit PBX. (see Subsection 3 Fig. c & e)</p>
2.16		<p>An output from the Service Process to a Channel Process related to a second call, eg Enquiry. (see Subsection 3 Fig. d & e)</p>
2.17		<p>An output from the Service Process to a Channel Process when either only one channel is involved in the call, (see Subsection 3 Fig a & b) or from the original call when a second call exists. (see Subsection 3 Fig d)</p>
2.18		<p>An output from the Service Process to a Channel Process of a Virtual Call.</p>
2.19		<p>An output from the Service Process to a Channel Process of a Virtual Channel in the incoming mode at a Transit or Branching Transit PBX. (see Subsection 3 Fig. c & e).</p>
2.20		<p>An output from the Service Process to a Channel Process of a Virtual Channel in the incoming mode at a Transit or Branching Transit PBX. (see Subsection 3 Fig. c & e).</p>
2.21		<p>An output from the Service Process to a Channel Process related to a second Virtual Call e.g. Diversion Follow Me Validation. (see Subsection 3 Fig. d)</p>
2.22		<p>An input to the Service Process from an extension.</p>

2. SDL SYMBOLS USED FOR LEVEL 3 DESCRIPTION IN DPNSS[188] AND DPNSS[189] (continued)

2.23

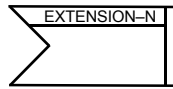

An input to the Service Process from second extension Process involved in the call
e.g. Divert on No – Reply on PBX.
(see Subsection 3 Fig. f)

2.24

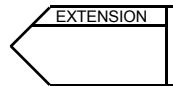

An output from the Service Process to an extension.

2.25



An output to a the Service Process to a second extension Process involved in the call
e.g. Divert on No – Reply on PBX.
(see Subsection 3 Fig. f)

2.26

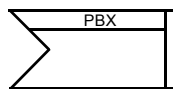

An input to the Service Process from the PBX Central process.

2.27

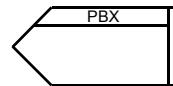

An output from the PBX Central Process to the Service Process.

2.28

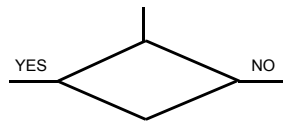

A decision symbol. This symbol may appear in any process. The knowledge to make the decision within the symbol is assumed to be available. Any interchange of signals between different processes to obtain information is not shown on the SDL diagrams.

2.29

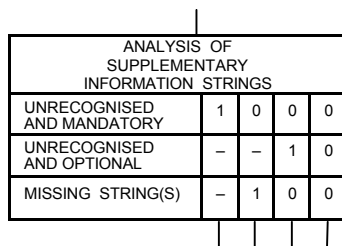

A decision table is similar to the diamond but can Show relationship between more than the one decision
1 means the condition is true
0 means the condition is false
- means the condition is unimportant
The knowledge to make the decision within the symbol is assumed to be available. Any interchange of signals between different processes to obtain information is not shown in the SDL diagrams.

2.30

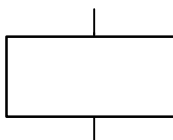

A task to be carried out by the PBX.

2.31

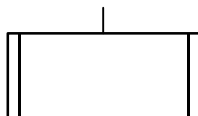

A macro of commonly used SDL the details of which are given in the SDL diagram referred to within the symbol.

2. SDL SYMBOLS USED FOR LEVEL 3 DESCRIPTION IN DPNSS[188] AND DPNSS[189] (continued)

2.32



A save symbol, The message is saved until the next state is entered.

2.33

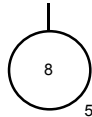

A connector to a figure in the same section of the specification. The digit outside the circle indicates on which figure the sequence continues. When the connector is another point on the same figure the digit is still included.

2.34

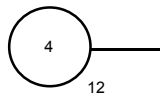

A connector from a figure(s) in the same section of the specification. The digit(s) outside the circle indicate from which figure(s) the sequence has come. When the connector is from another point on the same figure the digit is still included.

2.35

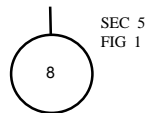

A connector to a figure in another section of the specification.

2.36

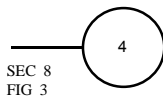

A connector from a figure(s) in another section of the specification.

2.37

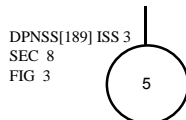

A connector to a figure in another specification.

2.38

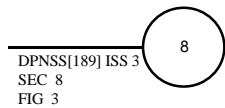

A connector from a figure(s) in another specification.

2.39

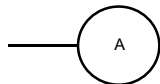

Continuation within the same figure to another sheet.

3 PBX/CHANNEL CONFIGURATIONS

The following Figures show the relationship between the various Channels involved in DPNSS 1 call and Supplementary Services.

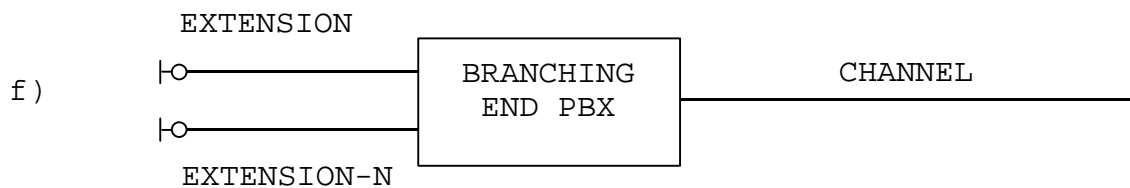
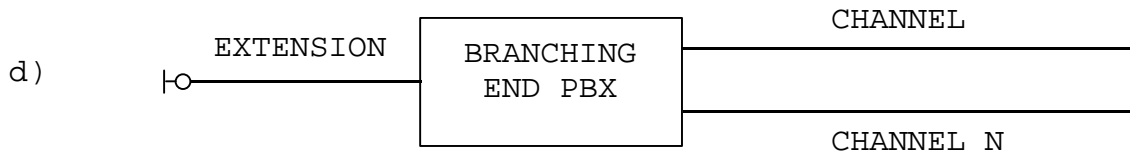
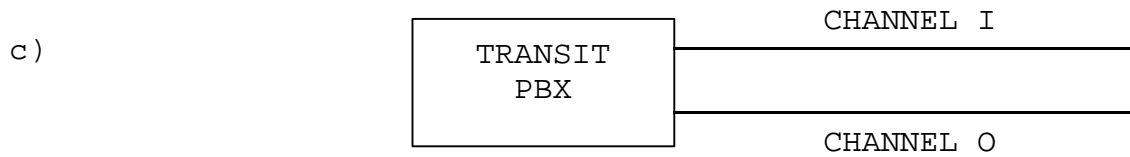
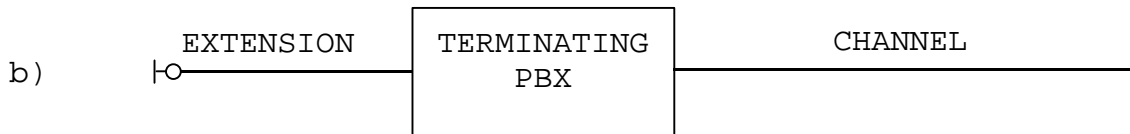
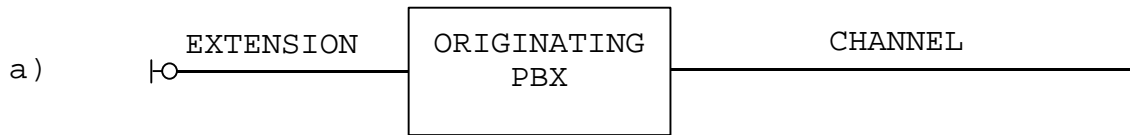

DIGITAL PRIVATE NETWORK SIGNALLING SYSTEM NO 1 (DPNSS 1)

SECTION 5

**ANNEX 3 : SDL DIAGRAMS FOR THE DPNSS 1 CHANNEL PROCESS AND
MAINTENANCE CHANNEL PROCESS**

CONTENTS

FIG. 1.	State Transition diagram for Channel Process	Page 3
FIG. 2.	Channel Idle	Page 4
FIG. 3.	Outgoing Service Requested	Page 5
FIG. 4.	Incoming Service Requested	Page 6
FIG. 5.	Set-up Complete	Page 7
FIG. 6.	Outgoing Recall Requested	Page 10
FIG. 7.	Incoming Recall Requested	Page 13
FIG. 8.	Connected Call Clearing	Page 16
FIG. 9.	Held Call Clearing	Page 18
FIG.10.	Release Channel	Page 20
FIG.11.	Check ISRM and associated SSRMs	Page 21
FIG.12.	Check CRM, LLRM or RRM	Page 23
FIG.13.	Check NAM	Page 24
FIG.14.	Check NIM	Page 25
FIG.15.	Check EEM	Page 26
FIG.16.	Check CCM	Page 29
FIG.17.	Check LLM	Page 30
FIG.18.	Check SM	Page 33
FIG.19.	Check RM or ERM and associated SSRMs	Page 34
FIG.20.	not used	
FIG.21.	Check SCRM	Page 37
FIG.22.	Check Unrecognised Message	Page 38
FIG.23.	Send ISRM and SSRM(s)	Page 39
FIG.24.	Send SSRM(s)	Page 40
FIG.25.	Send RM and SSRM	Page 41
FIG.26.	Send EEM	Page 42
FIG.27.	Send LLM	Page 43
FIG.28.	Select Route and Check Supplementary Information Strings within an ISRM	Page 44
FIG.29.	Select Route and Check Supplementary Information Strings within a RM/ERM	Page 46
FIG.30.	Send ERM and SSRM(s)	Page 48
FIG.31.	Maintenance Channel Process	Page 49
FIG.32.	Process Selector	Page 50

HISTORY

Issue 1 - December 1989 - Note: The heading text for this issue incorrectly shows "Issue 3"

Issue 4 - March 2001 - Specification renamed as DPNSS[188]
- SDL diagrams rearranged within some Figures to fit within standardised margins
- Figure 22 title corrected
- Figure 28 title corrected
- Figure 29 title corrected
- No technical changes made to the Annex

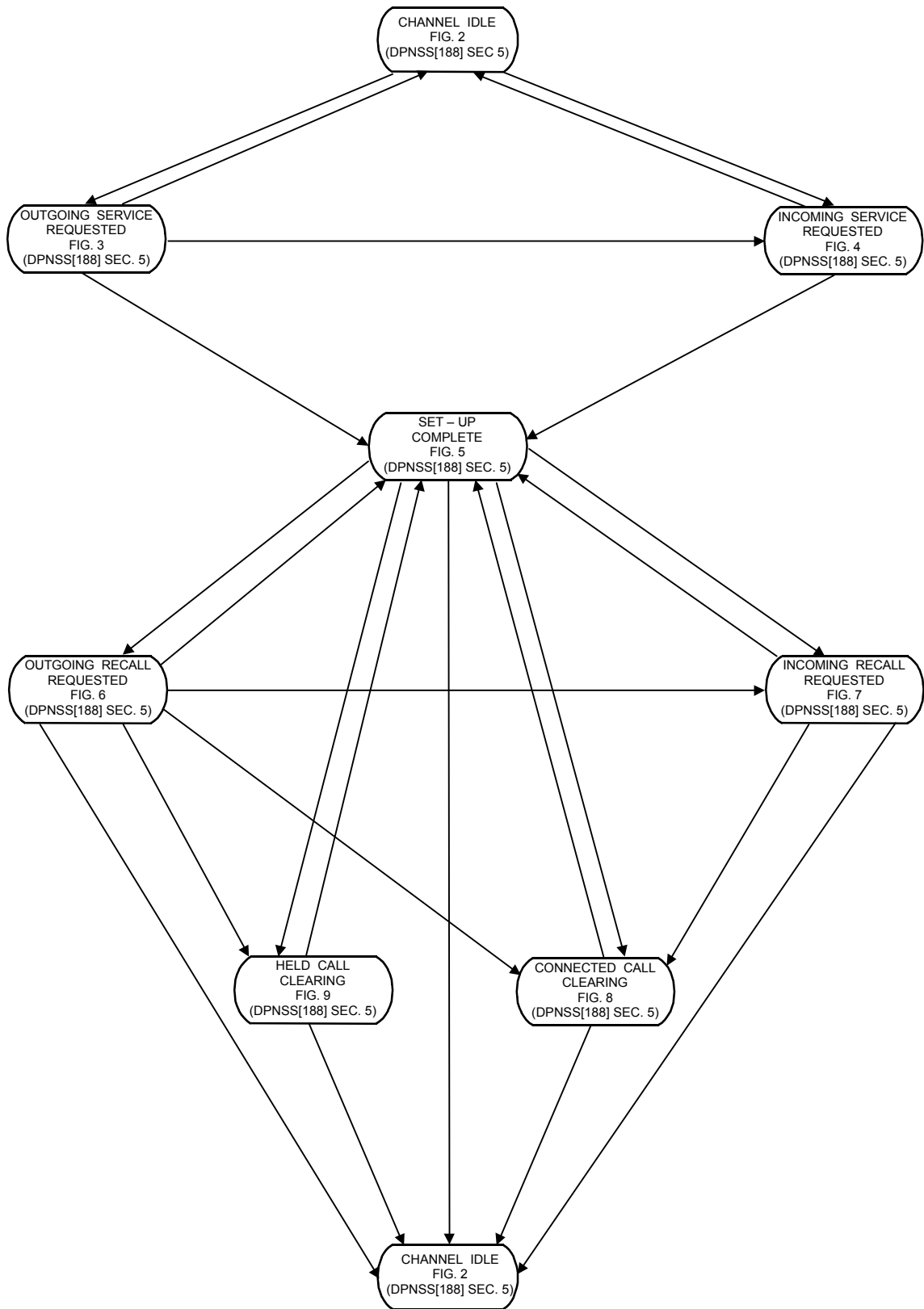

CHANNEL PROCESS: STATE TRANSITION DIAGRAM
FIG.1 (DPNSS[188] SECTION 5)

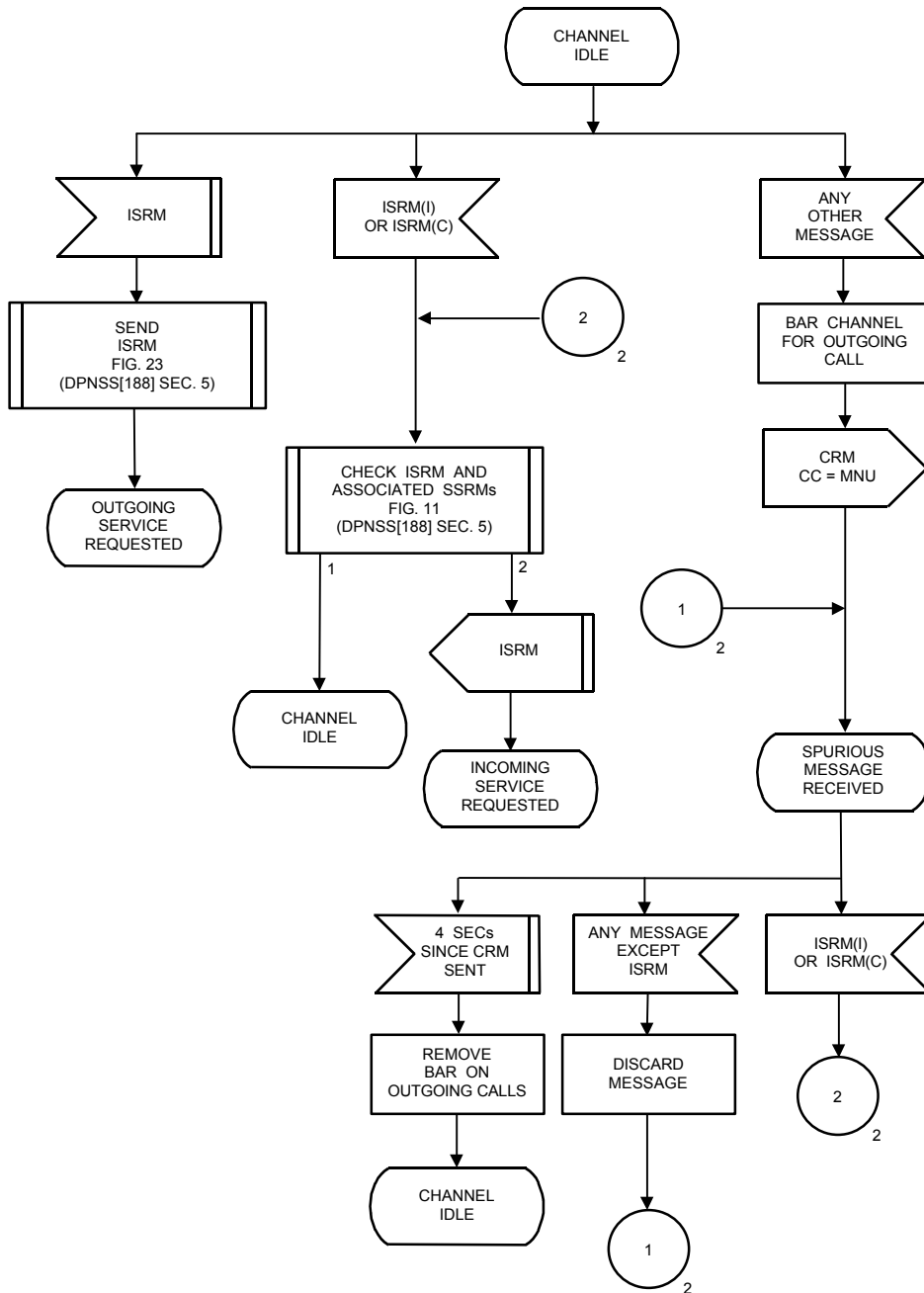

CHANNEL PROCESS: CHANNEL IDLE
FIG.2 (DPNSS[188] SECTION 5)

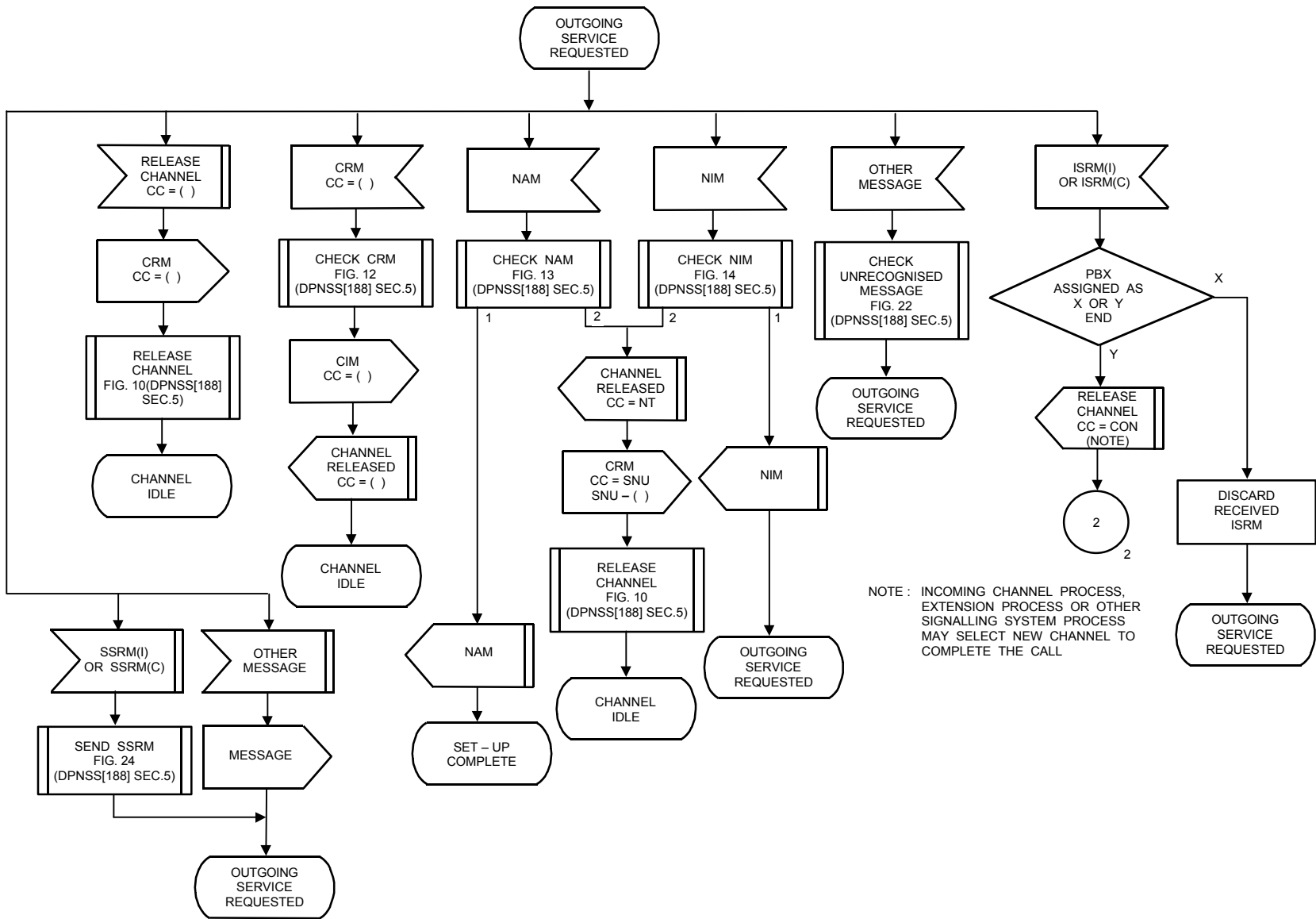

CHANNEL PROCESS: OUTGOING SERVICE REQUESTED
FIG.3 (DPNSS[188] SECTION 5)

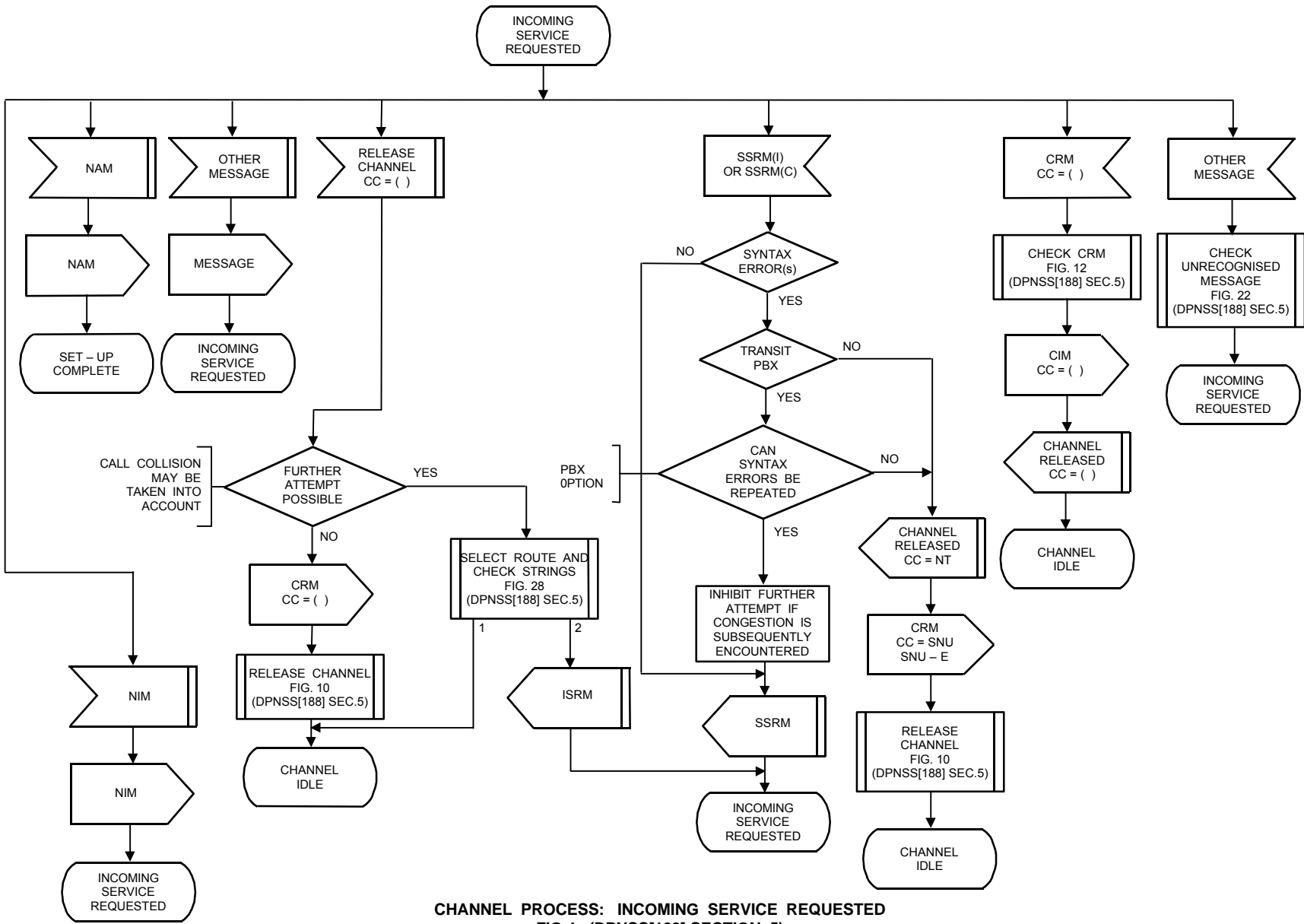

CHANNEL PROCESS: INCOMING SERVICE REQUESTED
FIG.4 (DPNSS[188] SECTION 5)

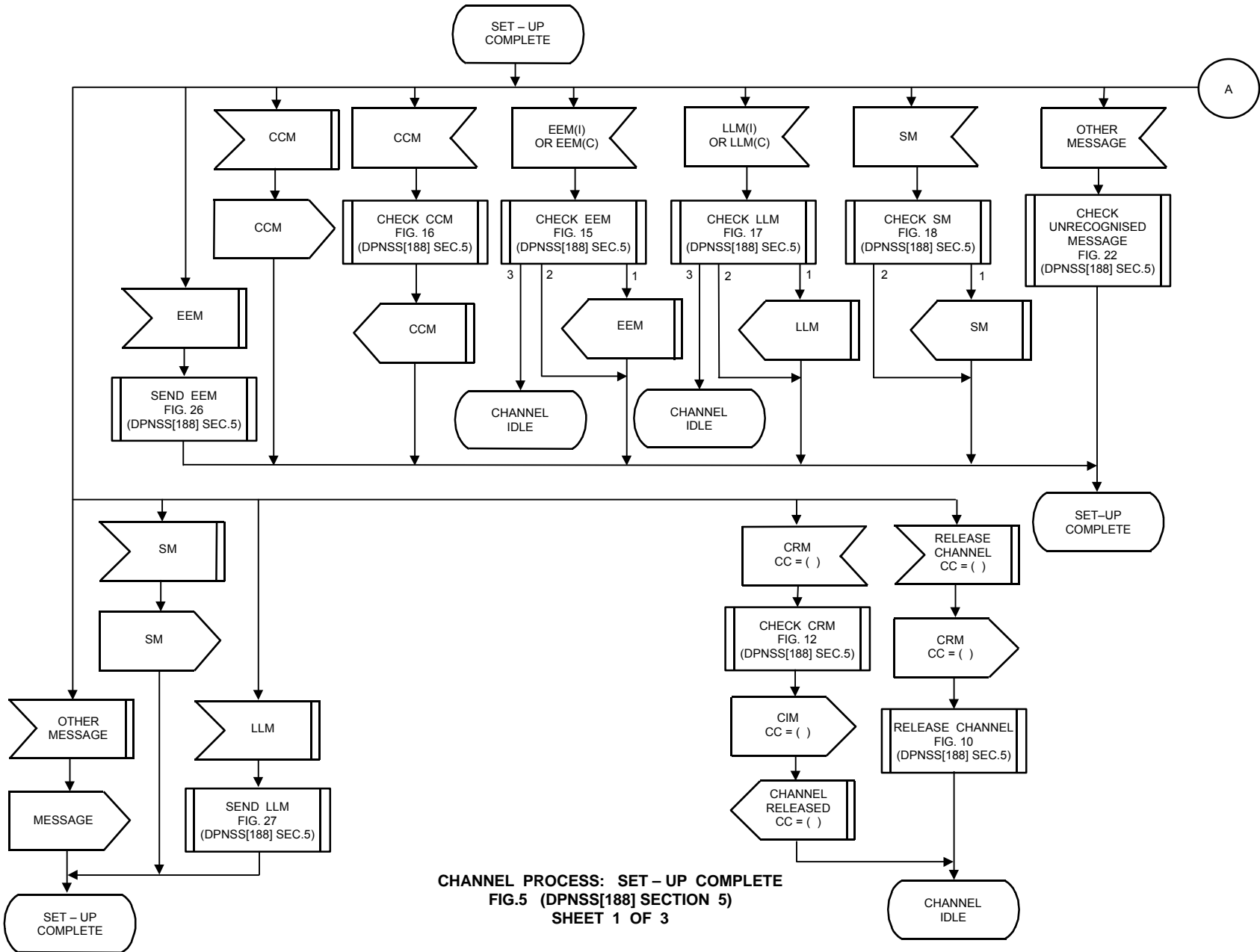

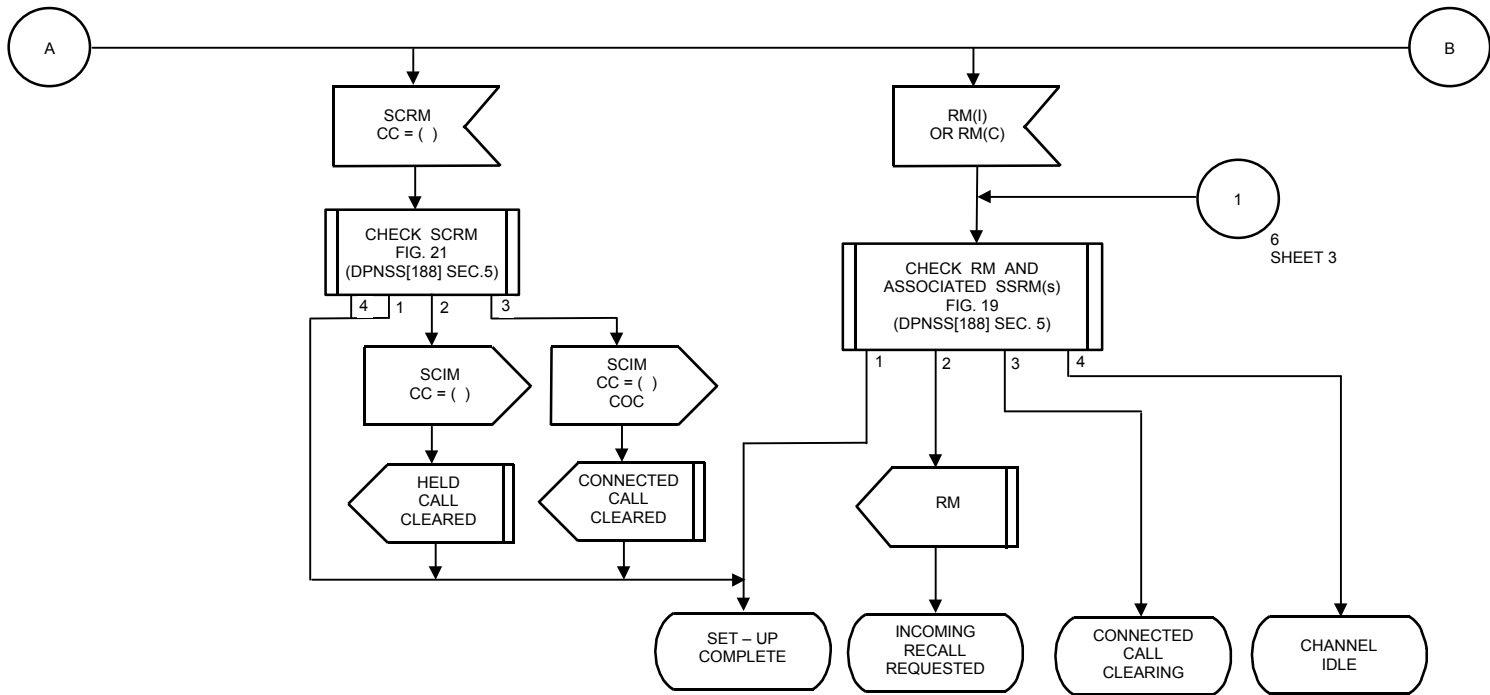

CHANNEL PROCESS: SET-UP COMPLETE
FIG.5 (DPNSS[188] SECTION 5)
SHEET 2 OF 3

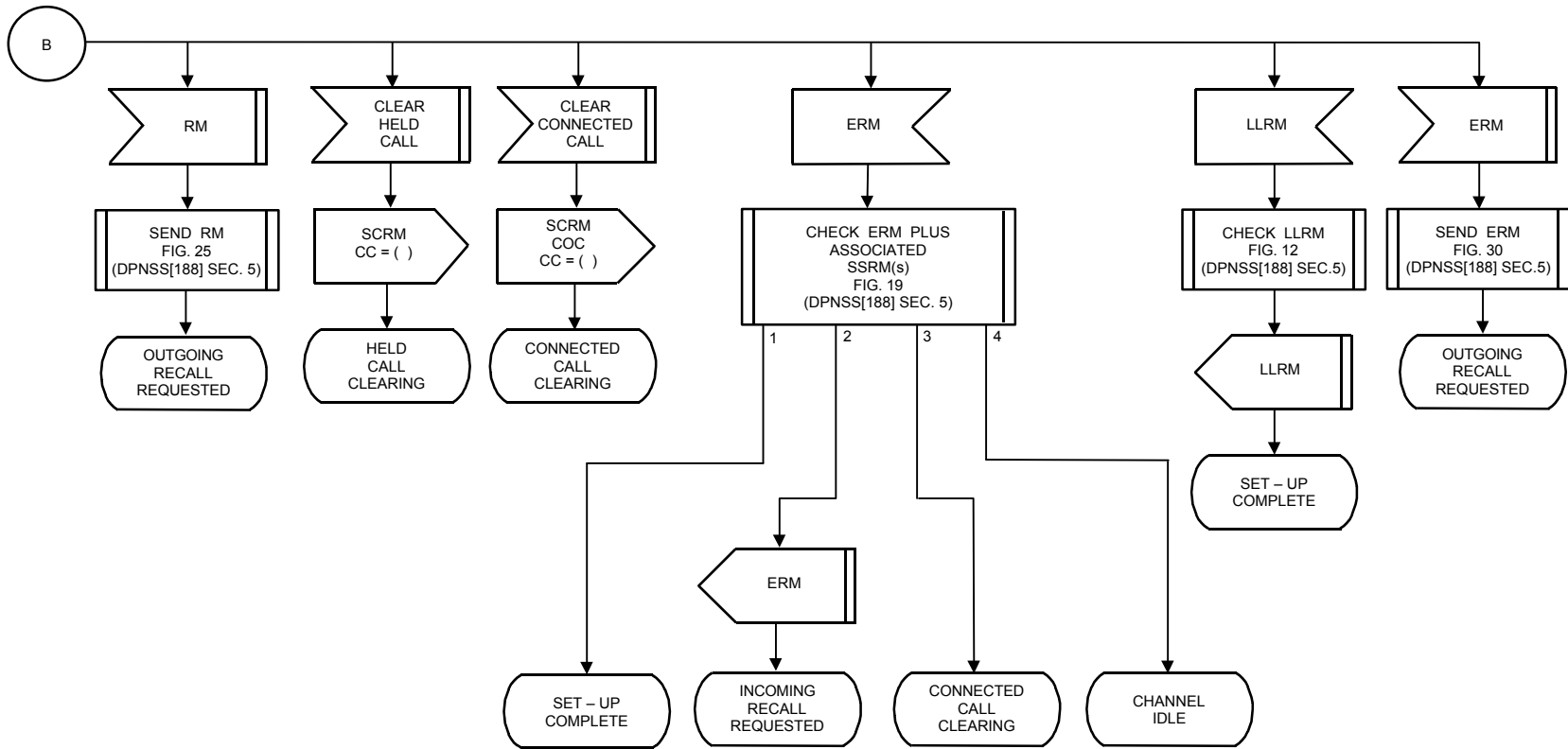

CHANNEL PROCESS: SET-UP COMPLETE
FIG.5 (DPNSS[188] SECTION 5)
SHEET 3 OF 3

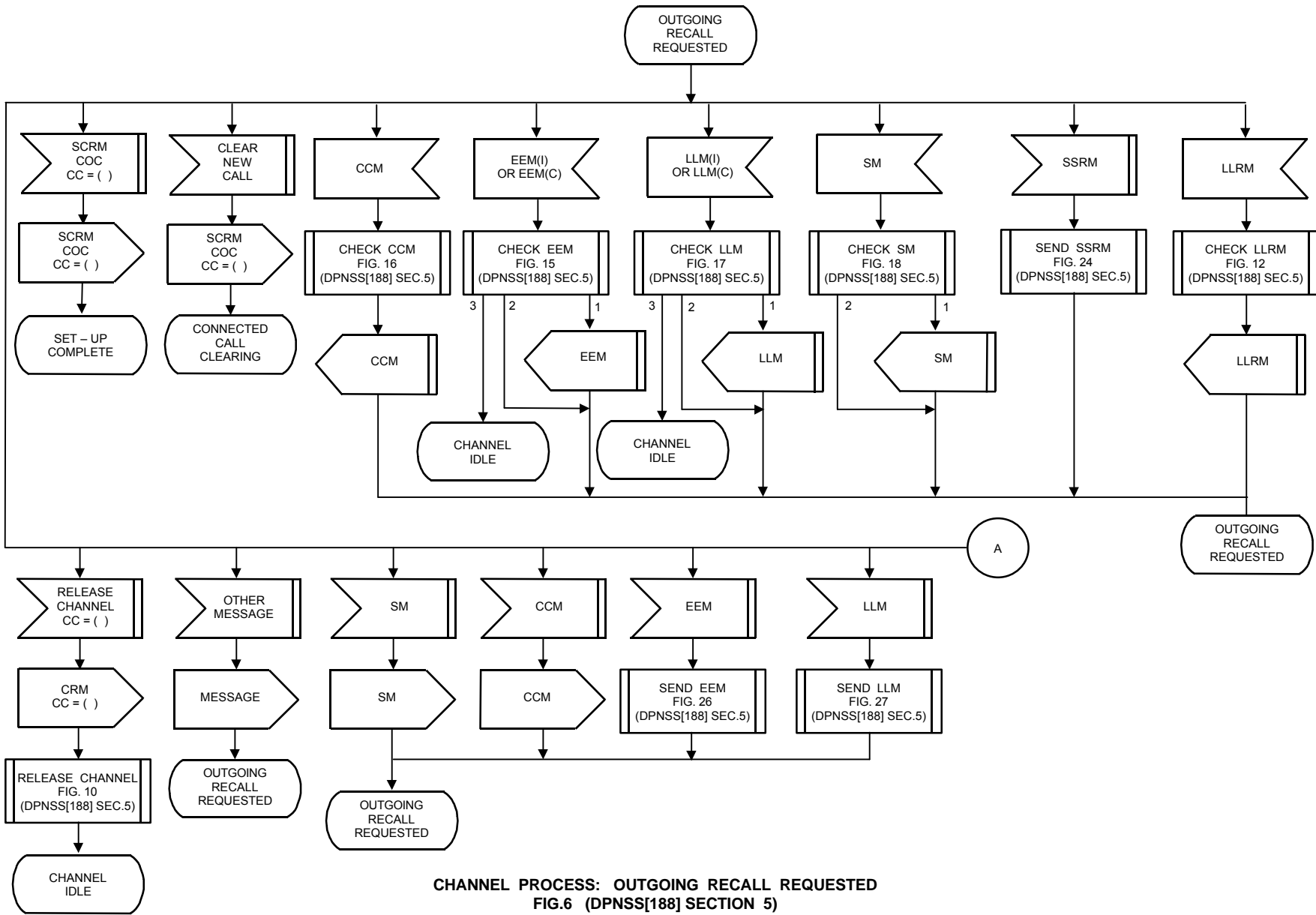

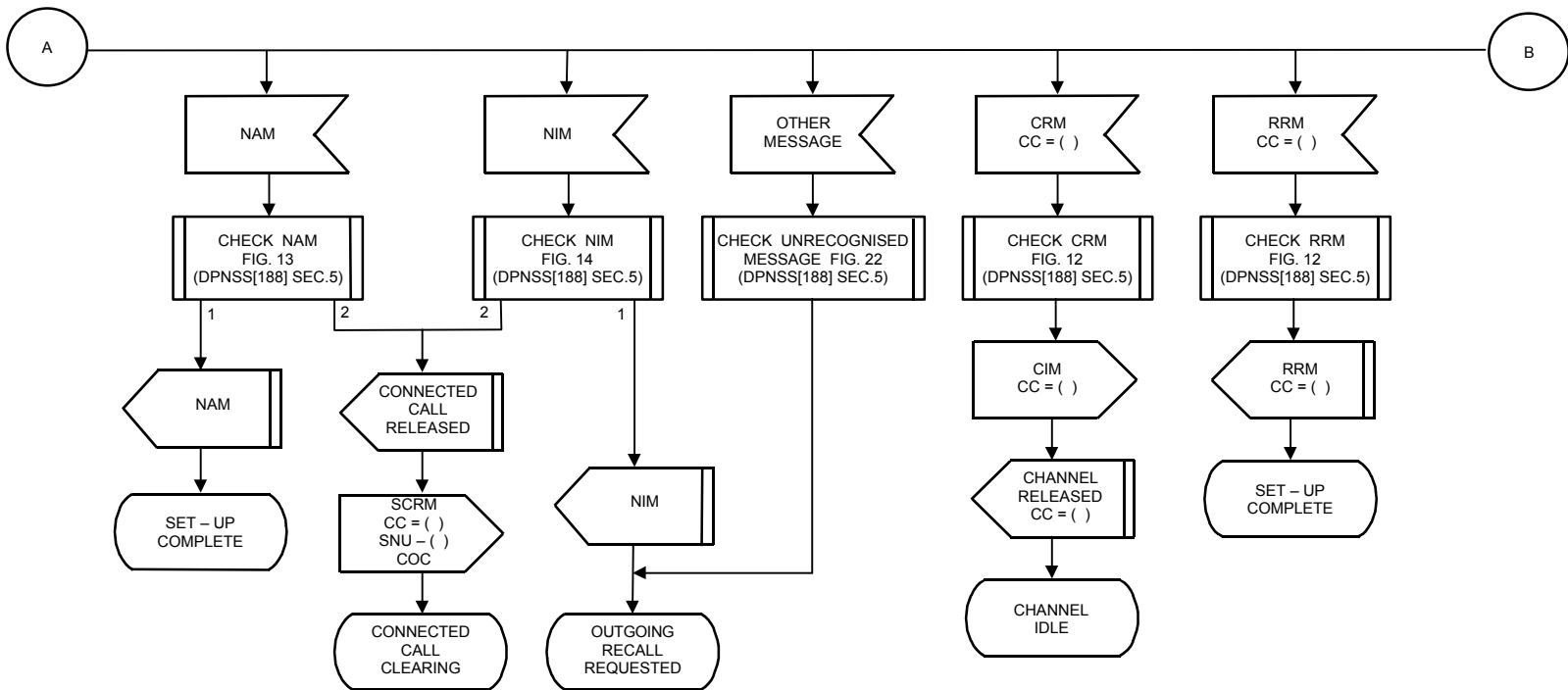

CHANNEL PROCESS: OUTGOING RECALL REQUESTED
FIG.6 (DPNSS[188] SECTION 5)
SHEET 2 OF 3

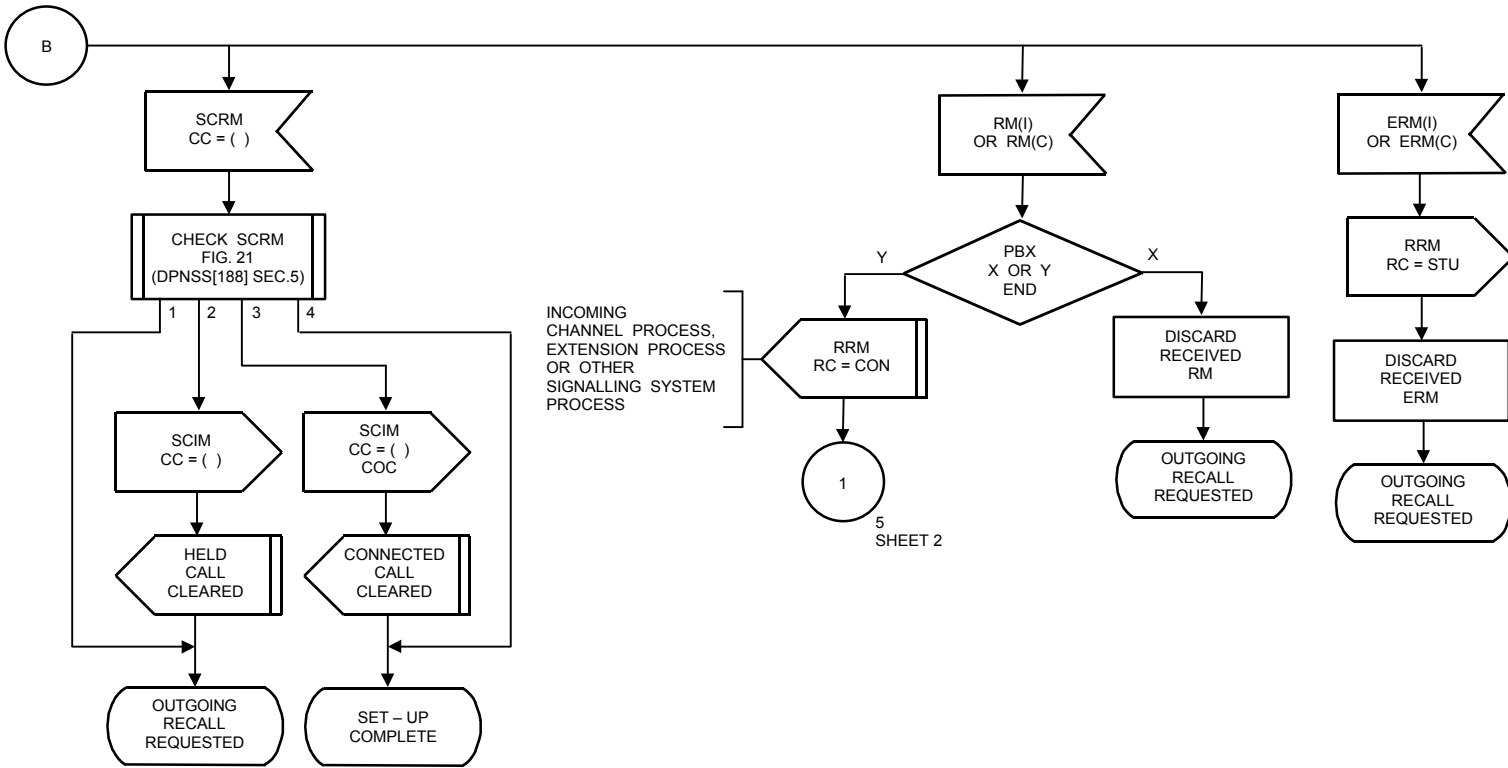

CHANNEL PROCESS: OUTGOING RECALL REQUESTED
FIG.6 (DPNSS[188] SECTION 5)
SHEET 3 OF 3

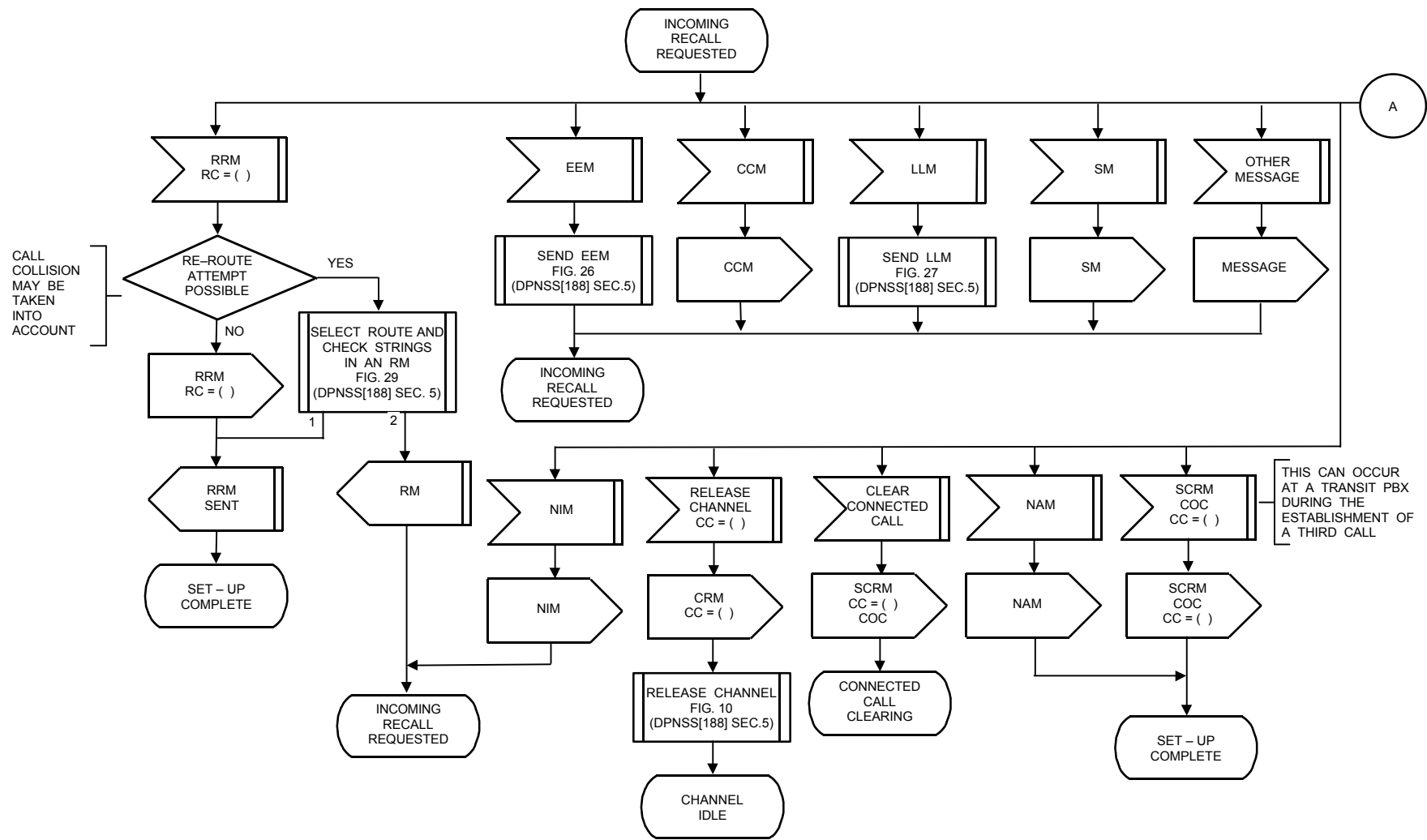

CHANNEL PROCESS: INCOMING RECALL REQUESTED
FIG.7 (DPNSS[188] SECTION 5)
SHEET 1 OF 3

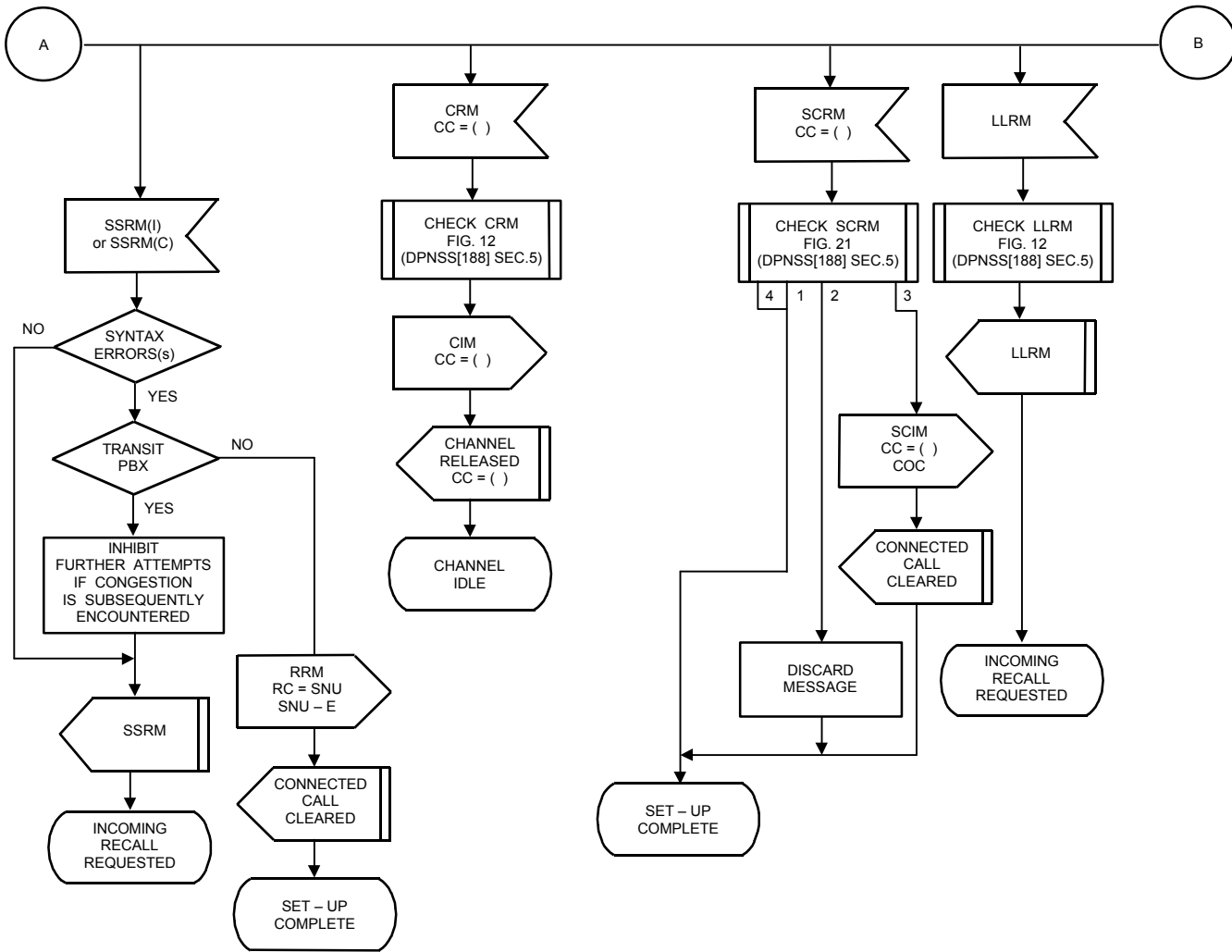

CHANNEL PROCESS: INCOMING RECALL REQUESTED
FIG.7 (DPNSS[188] SECTION 5)
SHEET 2 OF 3

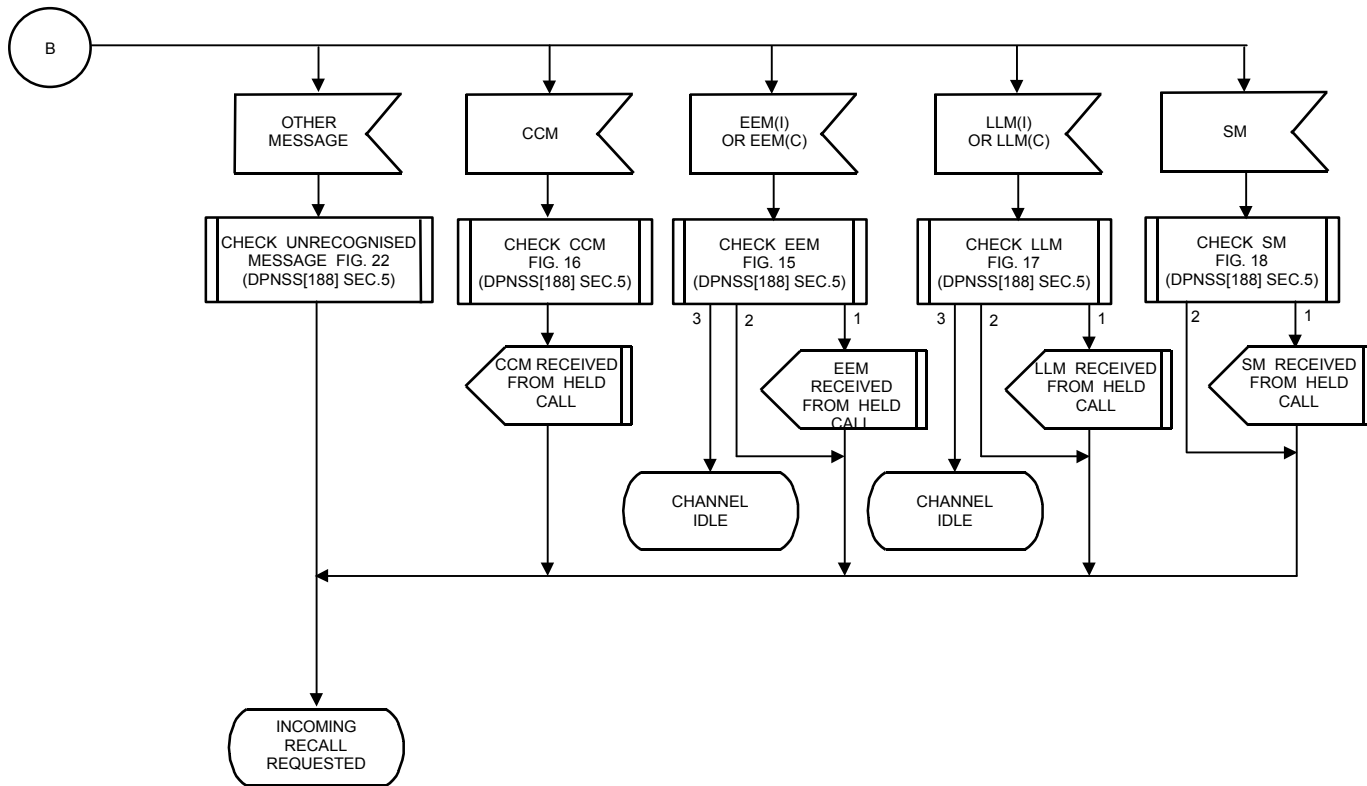

CHANNEL PROCESS: INCOMING RECALL REQUESTED
FIG.7 (DPNSS[188] SECTION 5)
SHEET 3 OF 3

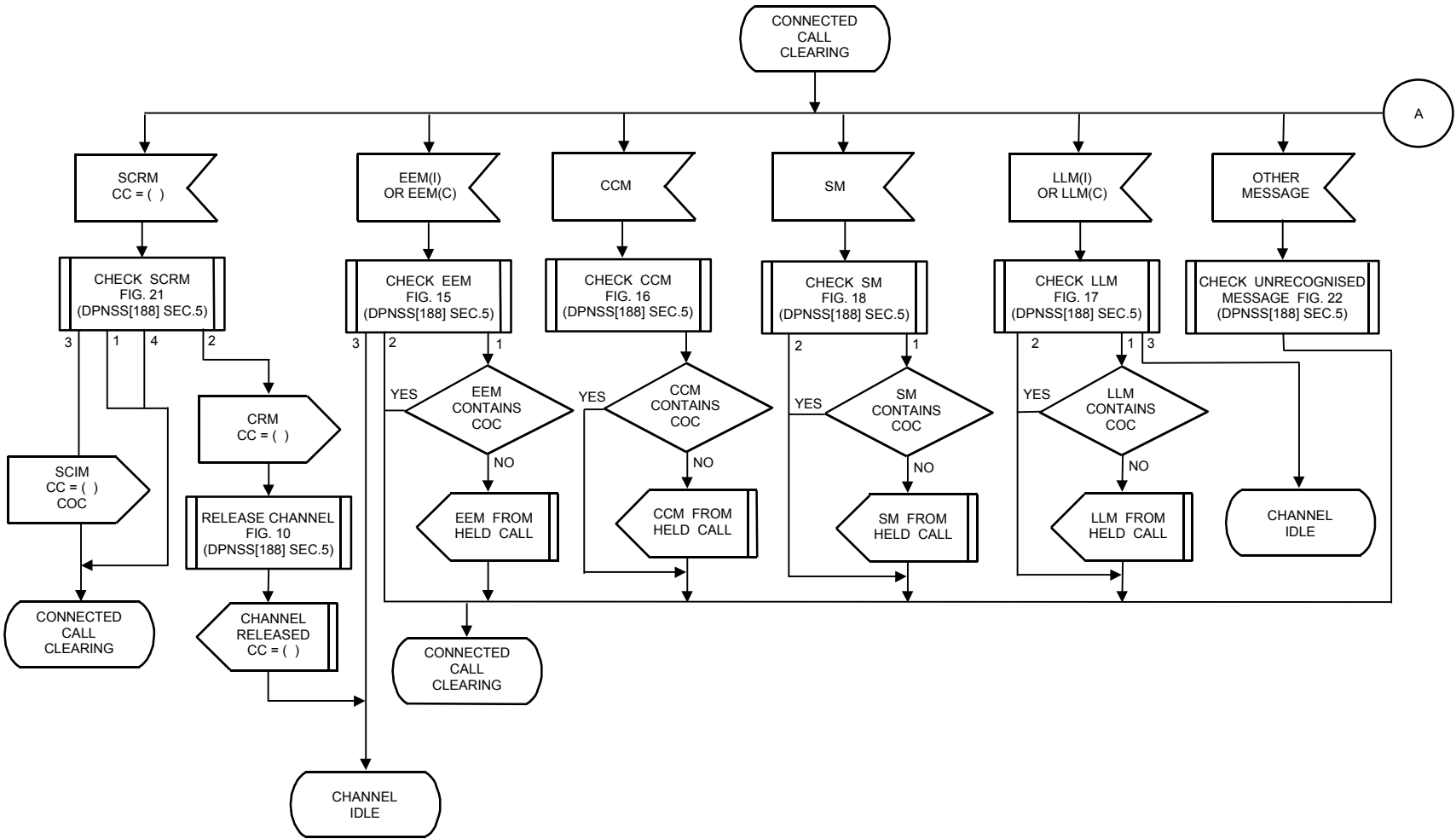

CHANNEL PROCESS: CONNECTED CALL CLEARING
FIG.8 (DPNSS[188] SECTION 5)
SHEET 1 OF 2

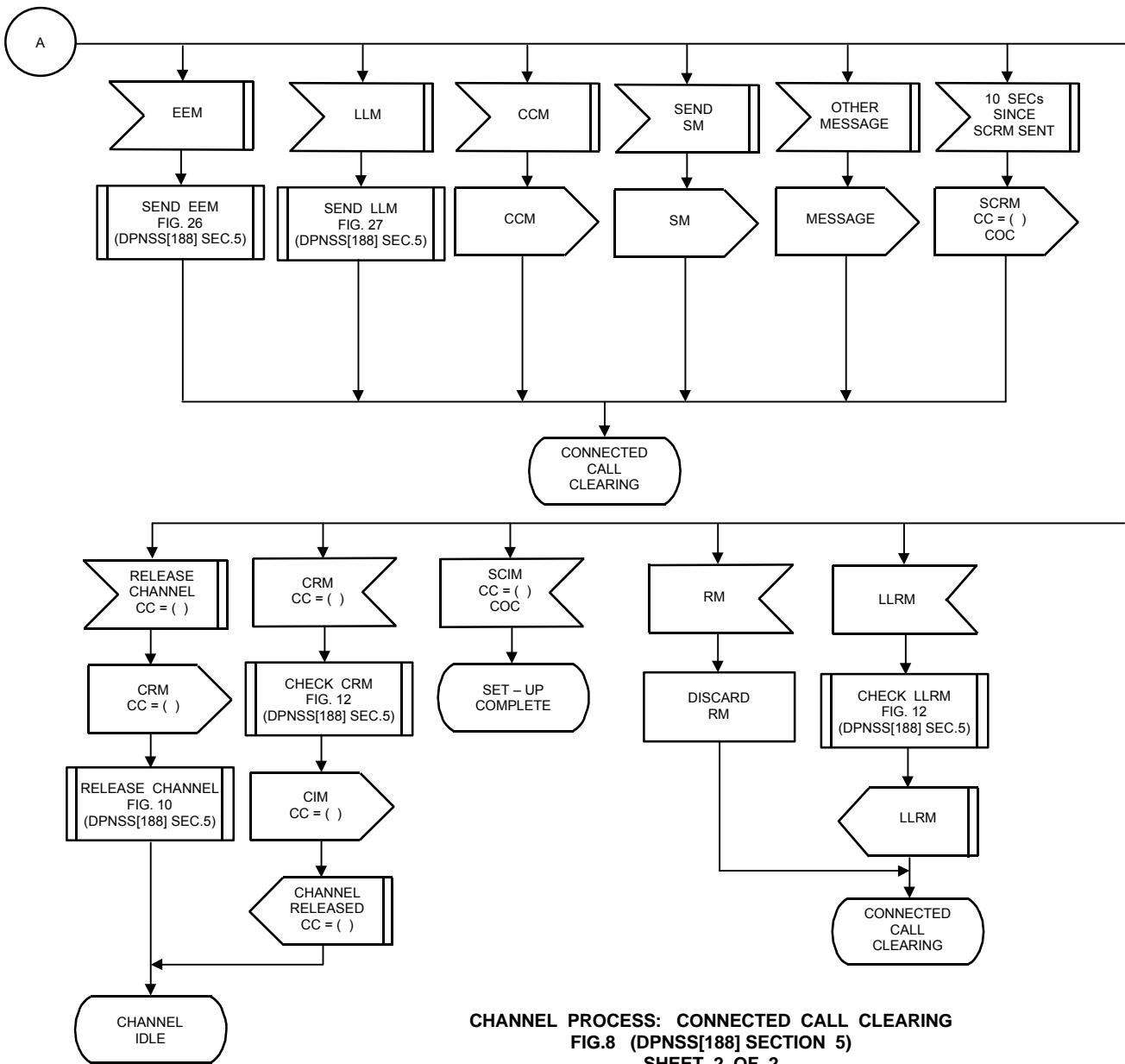

CHANNEL PROCESS: CONNECTED CALL CLEARING
FIG.8 (DPNSS[188] SECTION 5)
SHEET 2 OF 2

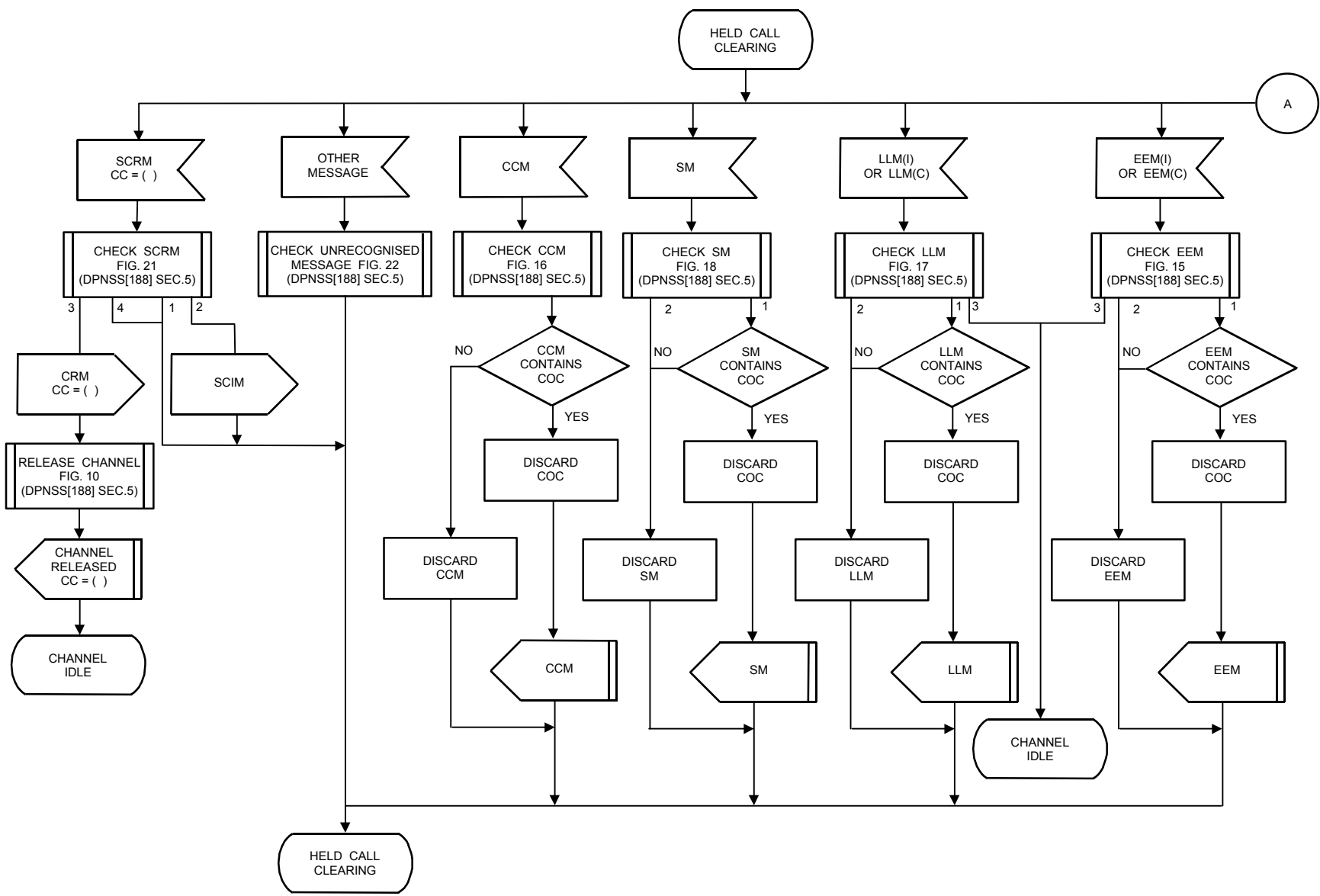

CHANNEL PROCESS: HELD CALL CLEARING
FIG.9 (DPNSS[188] SECTION 5)
SHEET 1 OF 2

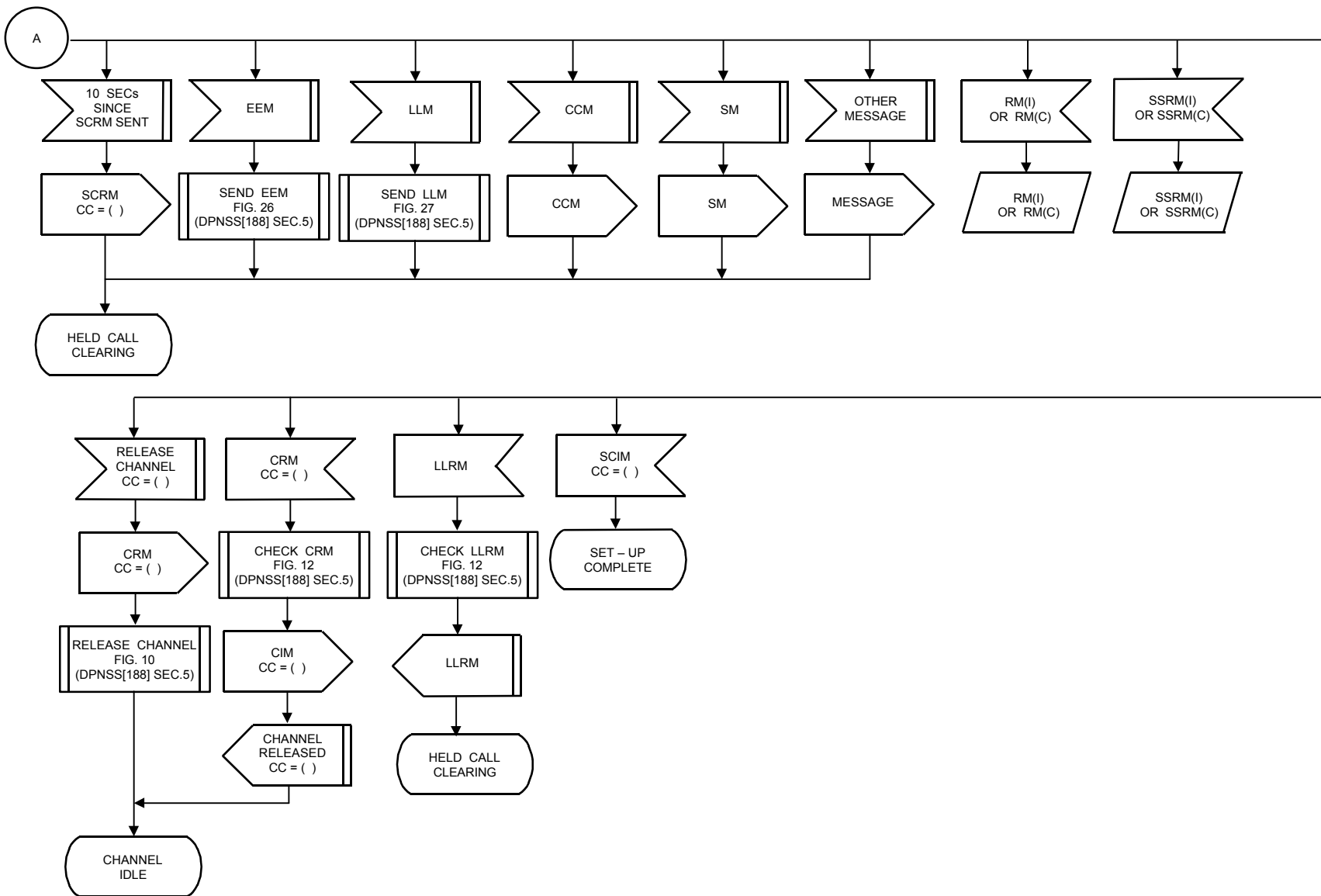

CHANNEL PROCESS: HELD CALL CLEARING
FIG.9 (DPNSS[188] SECTION 5)
SHEET 2 OF 2

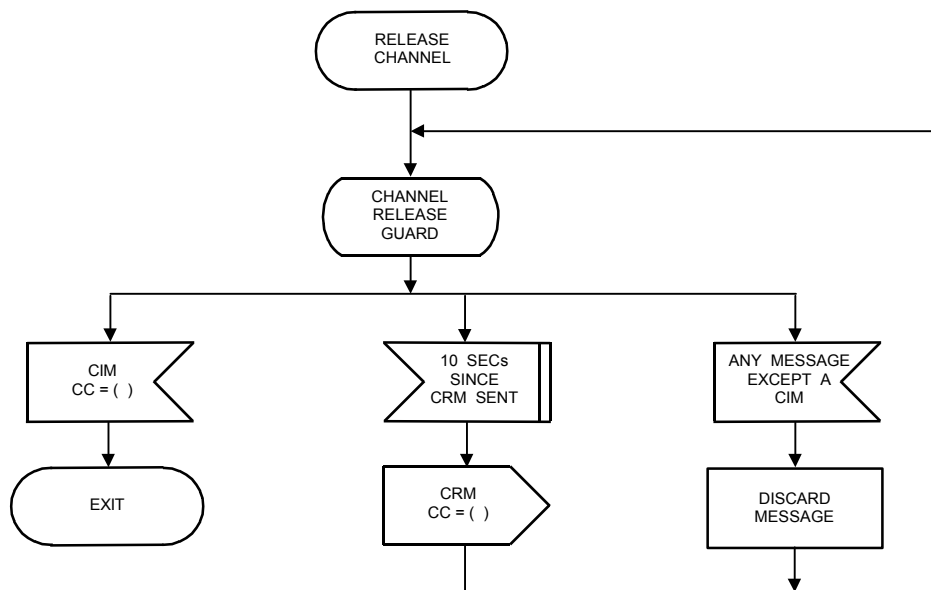

CHANNEL PROCESS: RELEASE CHANNEL
FIG.10 (DPNSS[188] SECTION 5)

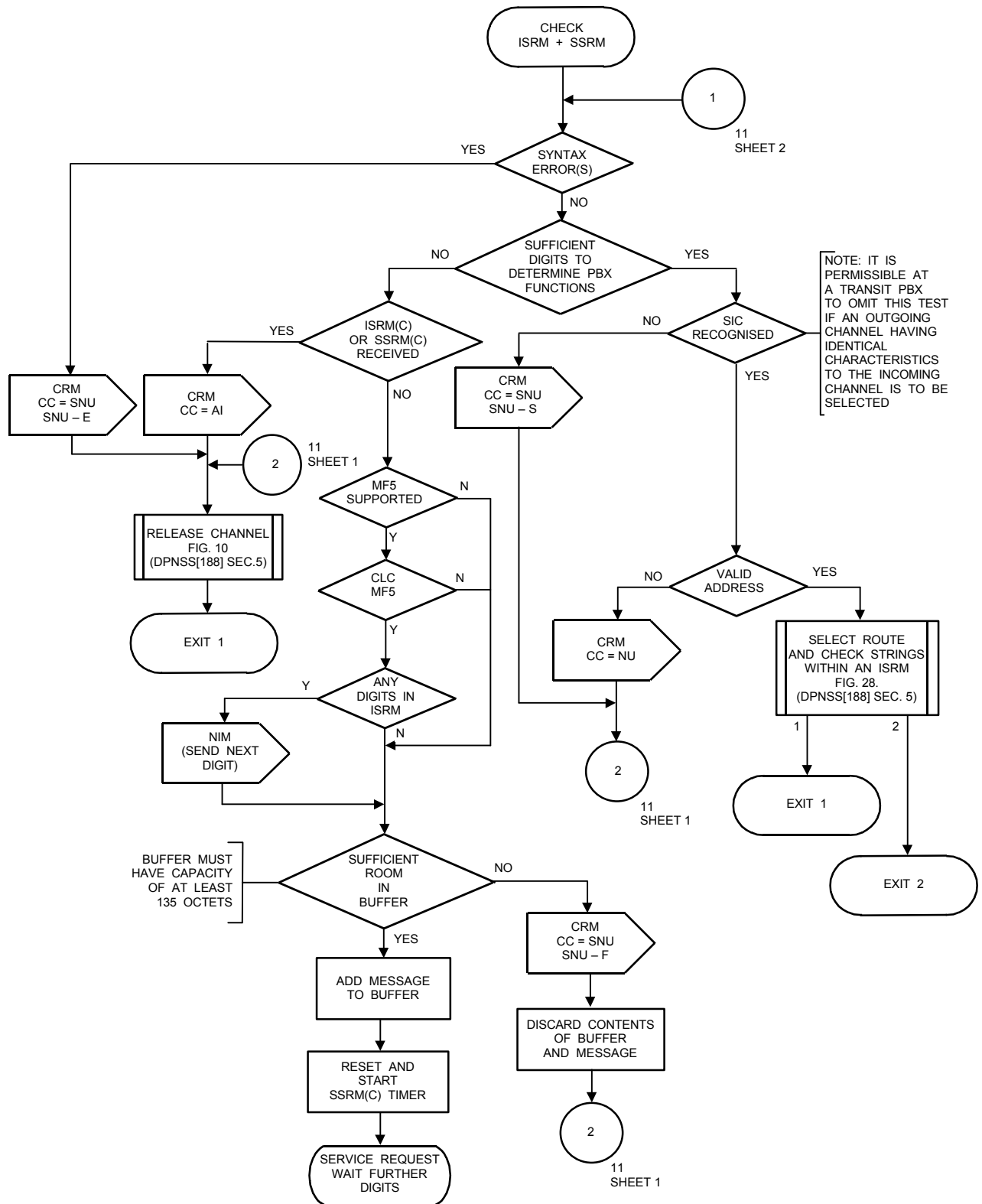

CHANNEL PROCESS: CHECK ISRM AND ASSOCIATED SSRM(s)
FIG.11 (DPNSS[188] SECTION 5)
SHEET 1 OF 2

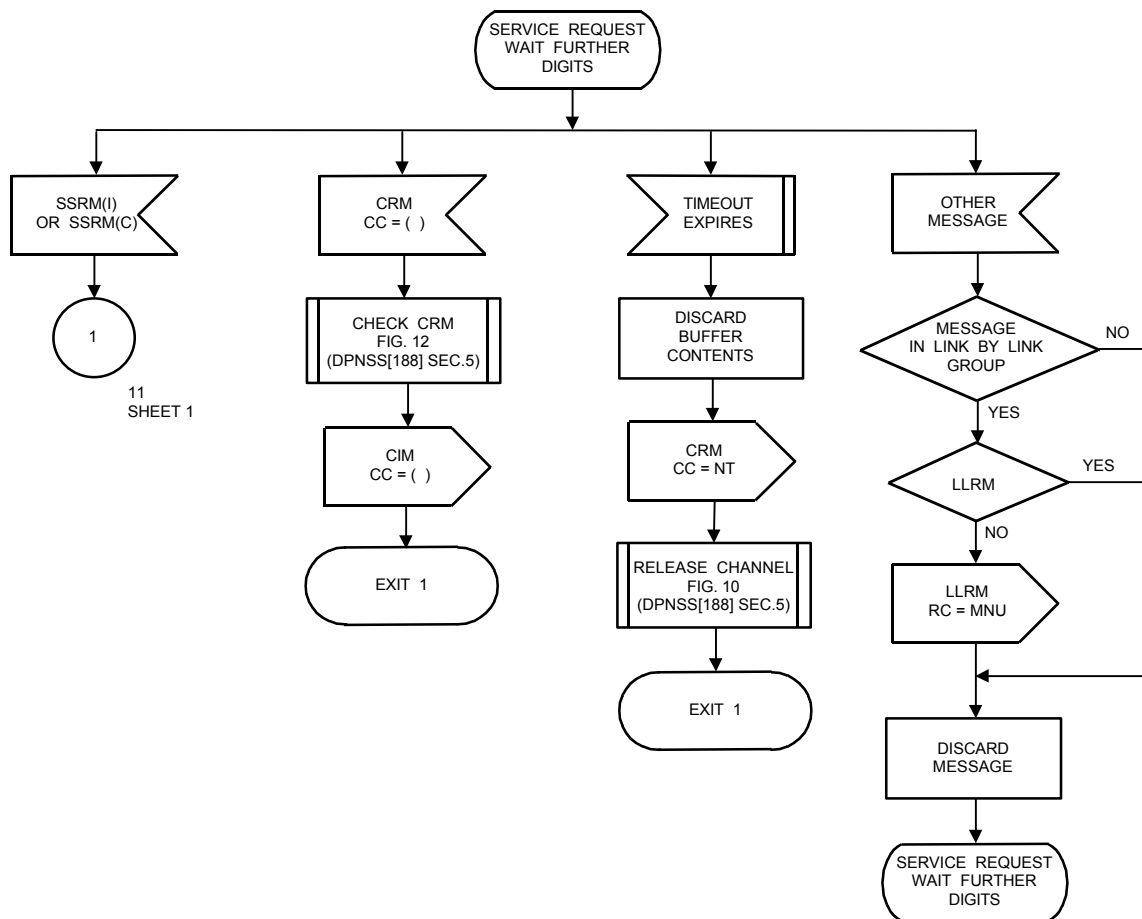

CHANNEL PROCESS: CHECK ISRM AND ASSOCIATED SSRM(s)
FIG.11 (DPNSS[188] SECTION 5)
SHEET 2 OF 2

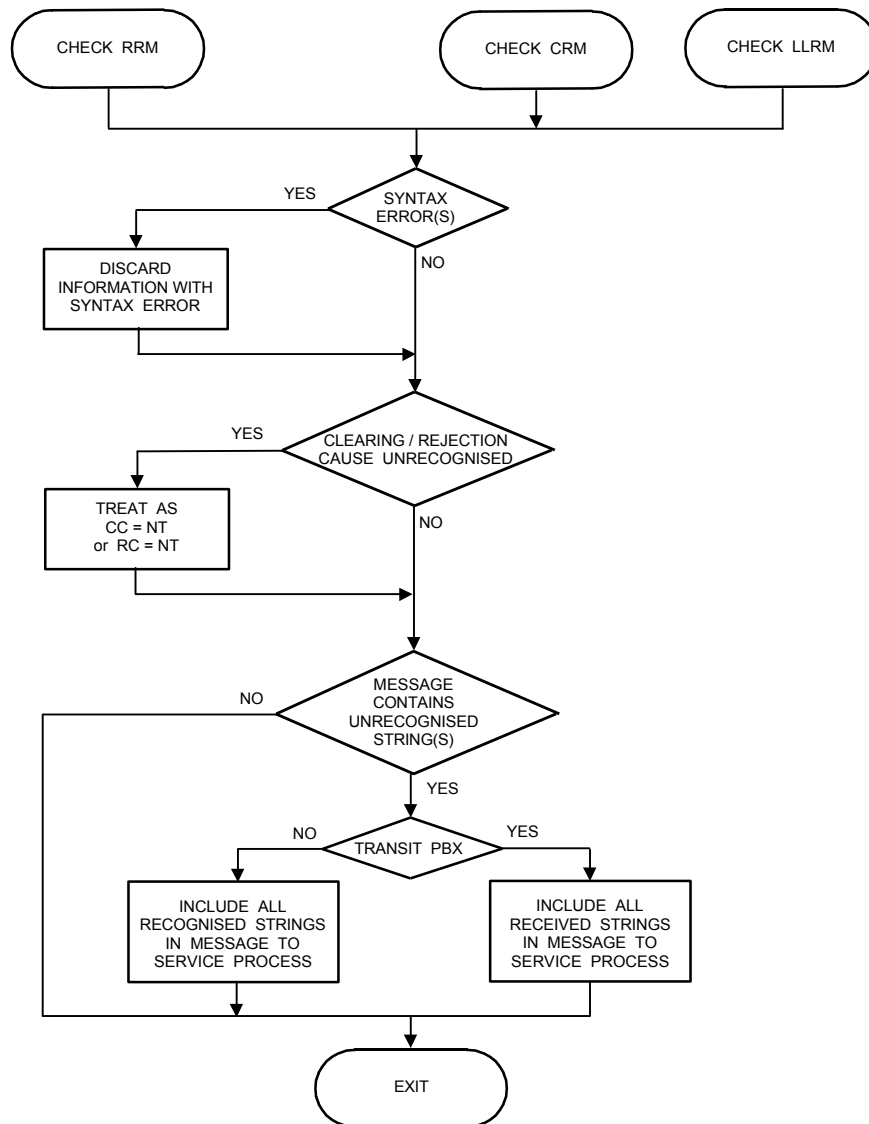

NOTE : A TRANSIT PBX WILL
PASS ON A CRM
UNCHANGED AND RETURN
A CIM IDENTICAL TO THE
RECEIVED CRM

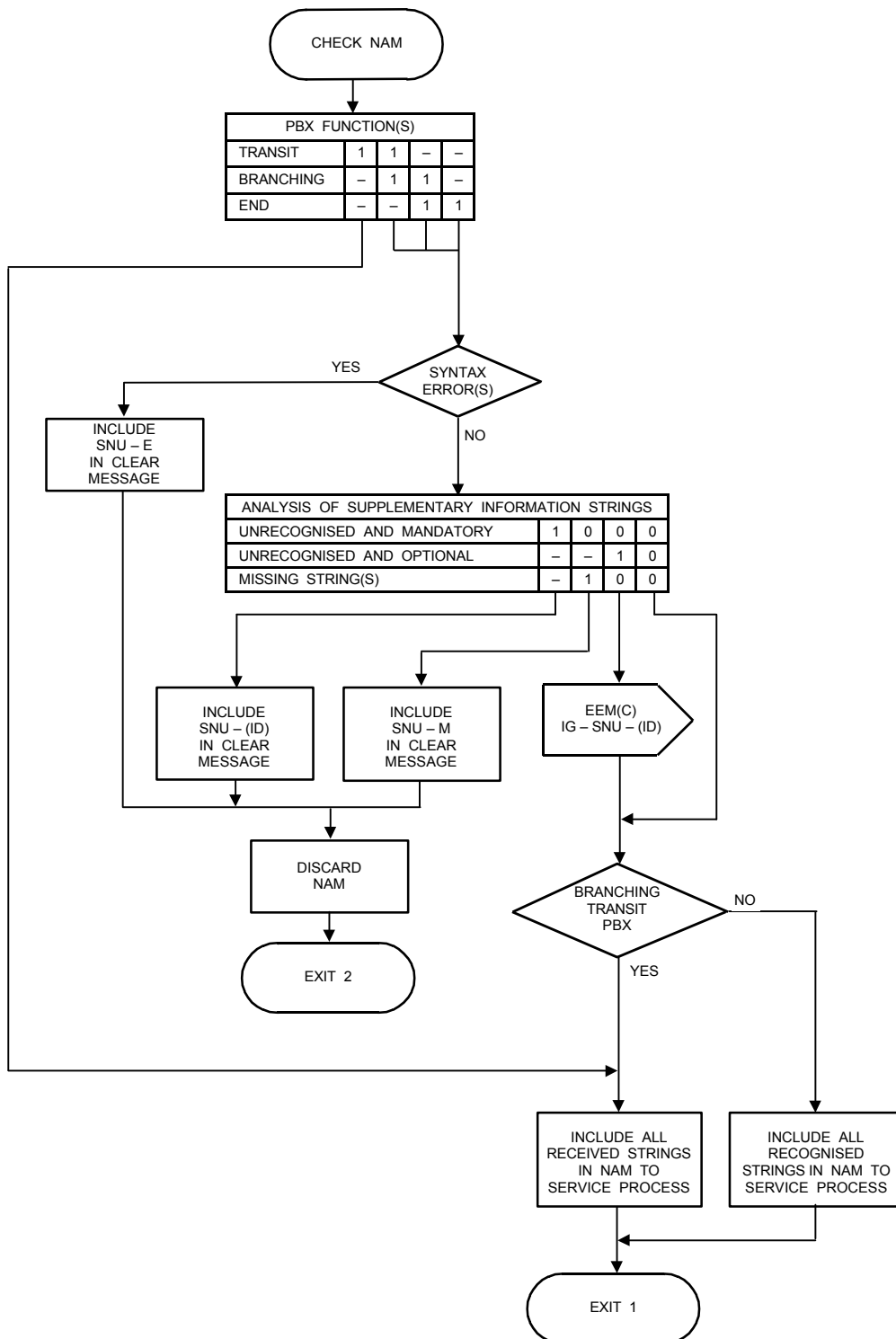

CHANNEL PROCESS: CHECK NAM FOR INCOMPLETE OR UNRECOGNISED CONTENTS
FIG.13 (DPNSS[188] SECTION 5)

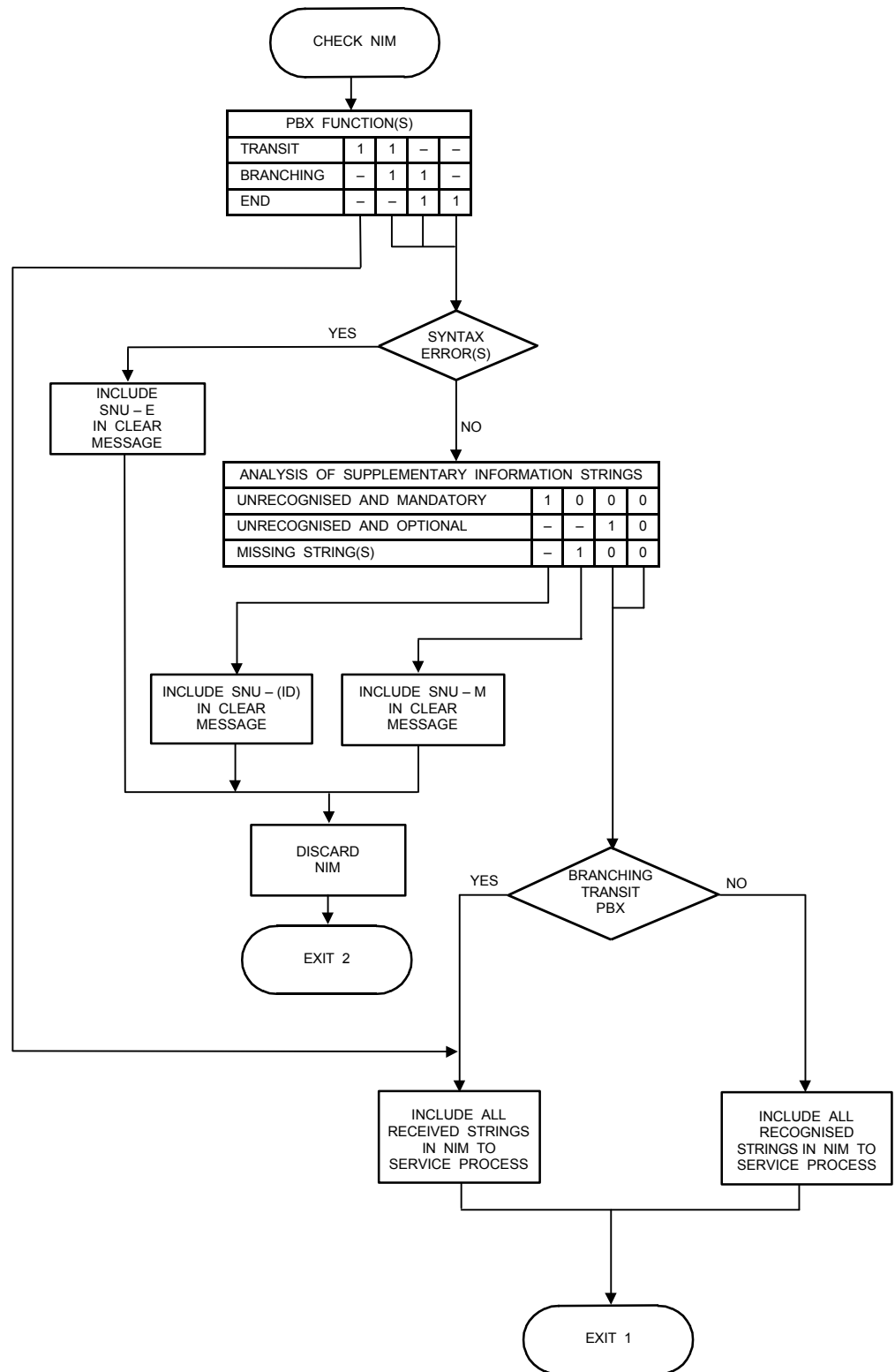

CHANNEL PROCESS: CHECK NIM FOR INCOMPLETE OR UNRECOGNISED CONTENTS
FIG.14 (DPNSS[188] SECTION 5)

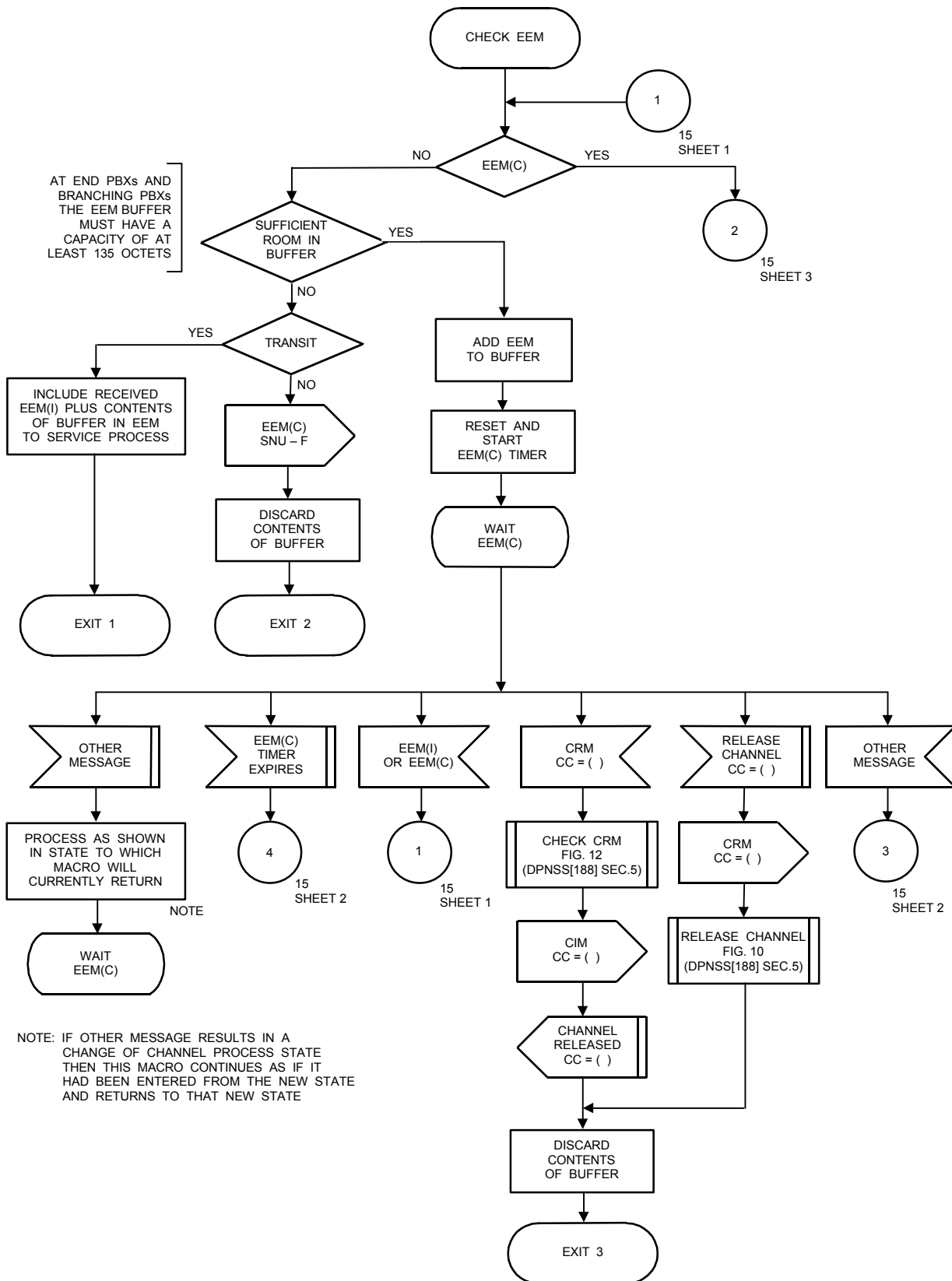

CHANNEL PROCESS: CHECK EEM FOR INCOMPLETE OR UNRECOGNISED CONTENTS
FIG.15 (DPNSS[188] SECTION 5) SHEET 1 OF 3

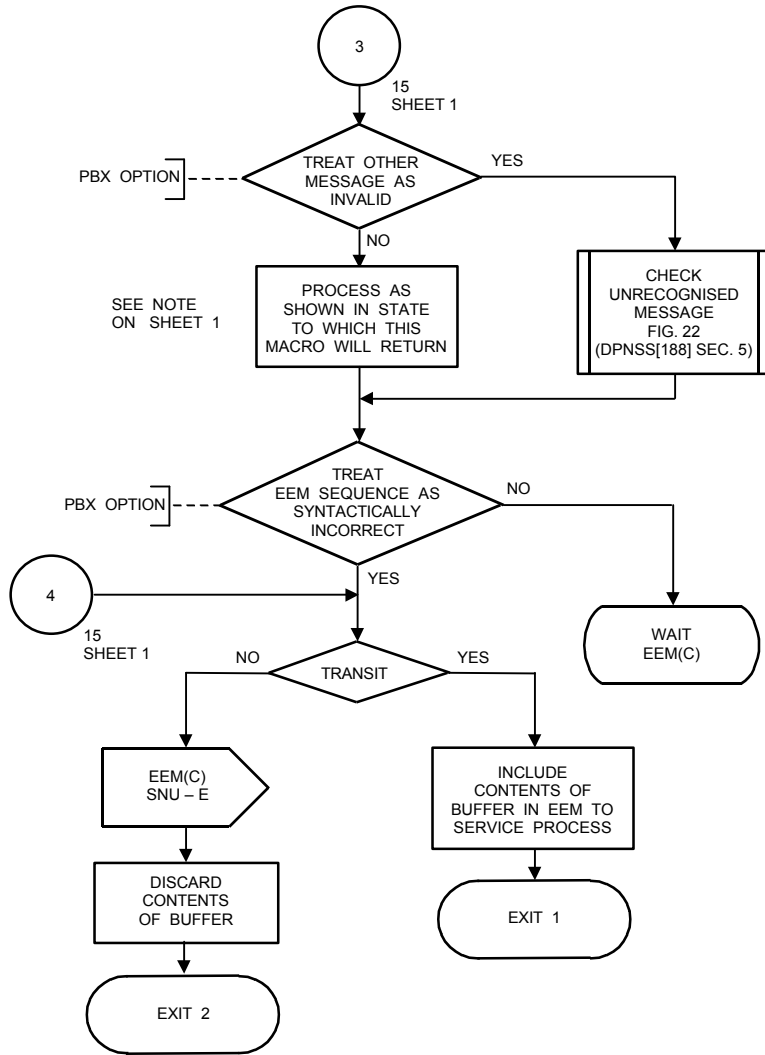

CHANNEL PROCESS: CHECK EEM FOR INCOMPLETE OR UNRECOGNISED CONTENTS
FIG.15 (DPNSS[188] SECTION 5) SHEET 2 OF 3

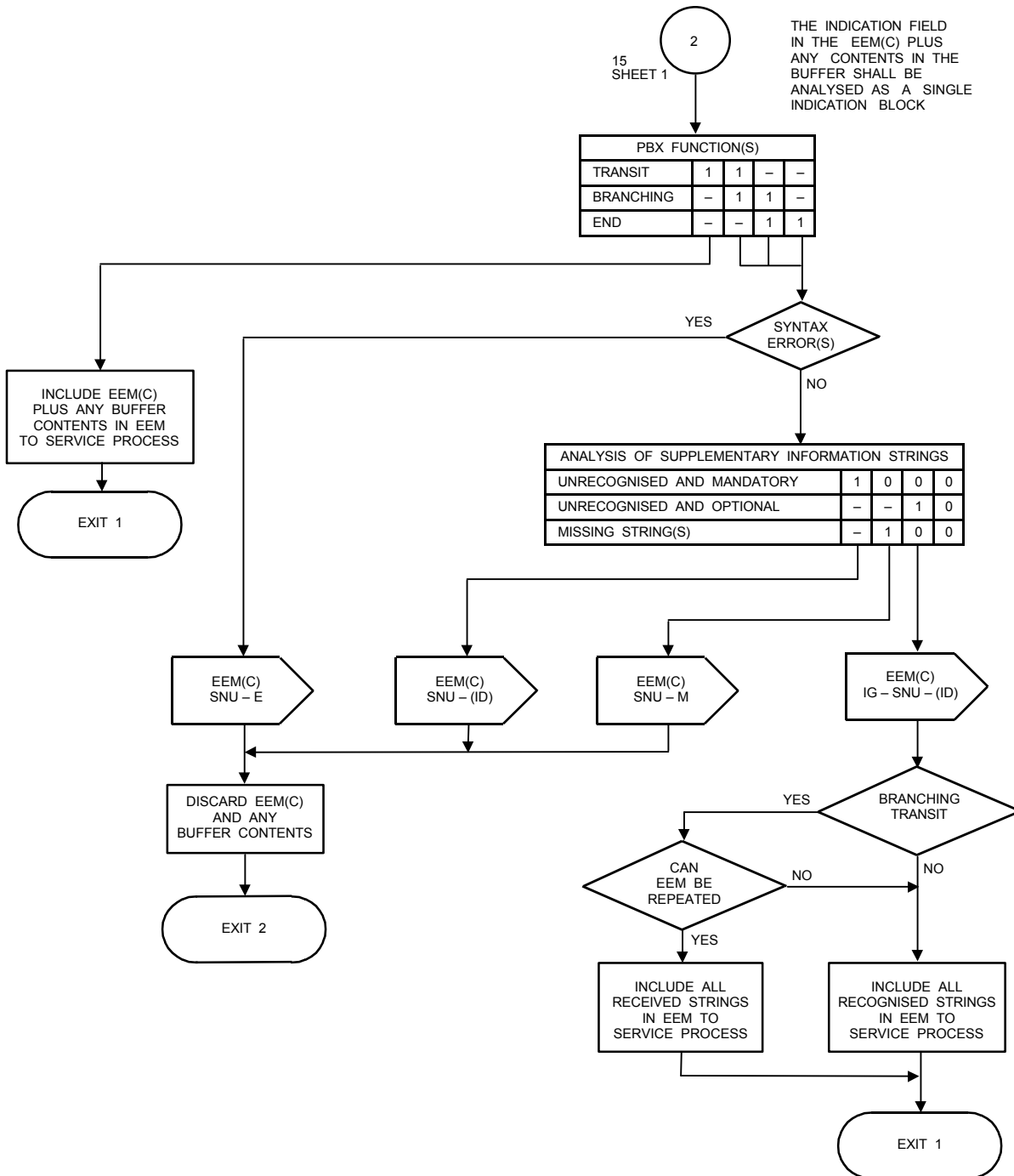

CHANNEL PROCESS: CHECK EEM FOR INCOMPLETE OR UNRECOGNISED CONTENTS
FIG.15 (DPNSS[188] SECTION 5) SHEET 3 OF 3

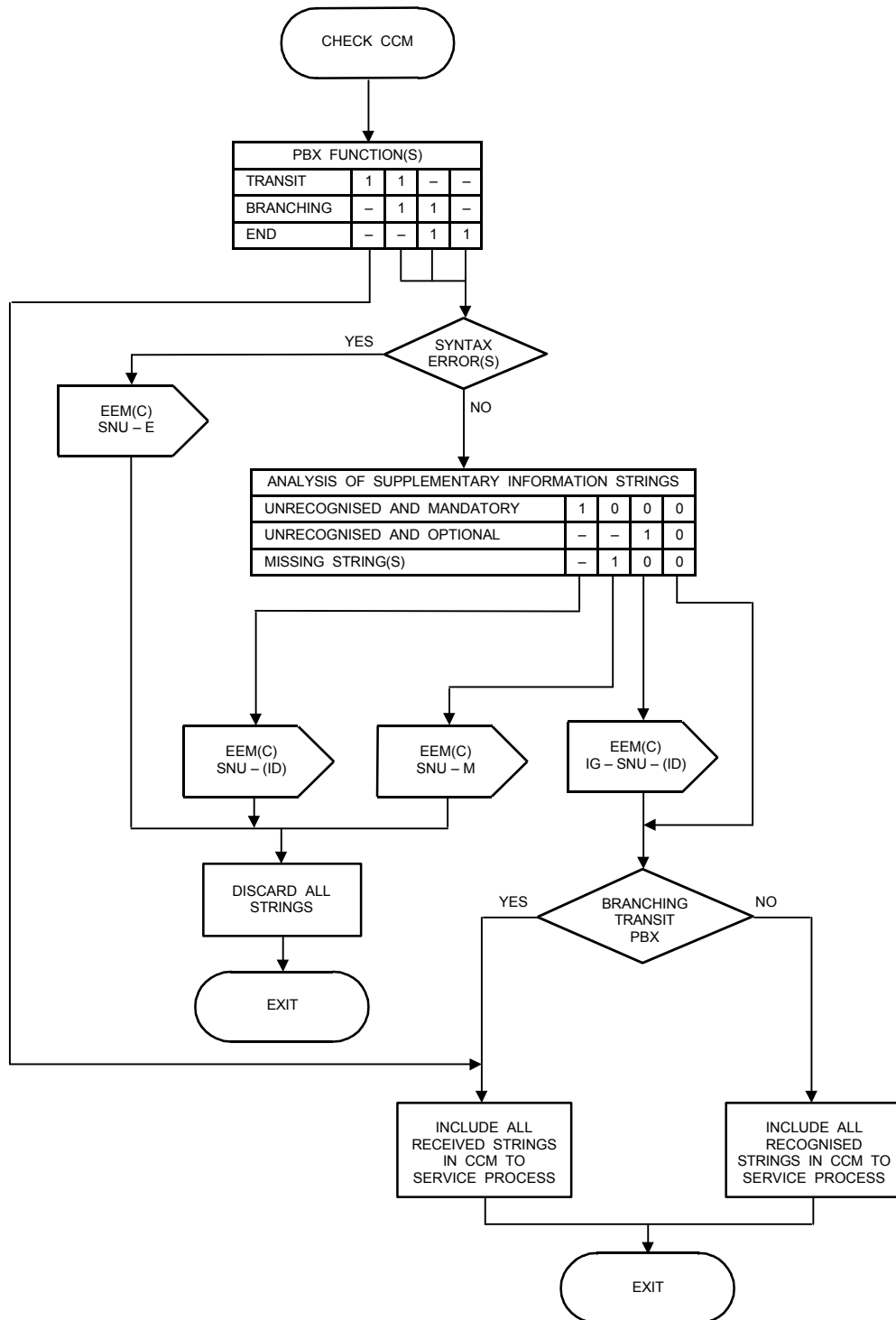

CHANNEL PROCESS: CHECK CCM FOR INCOMPLETE OR UNRECOGNISED CONTENTS
FIG.16 (DPNSS[188] SECTION 5)

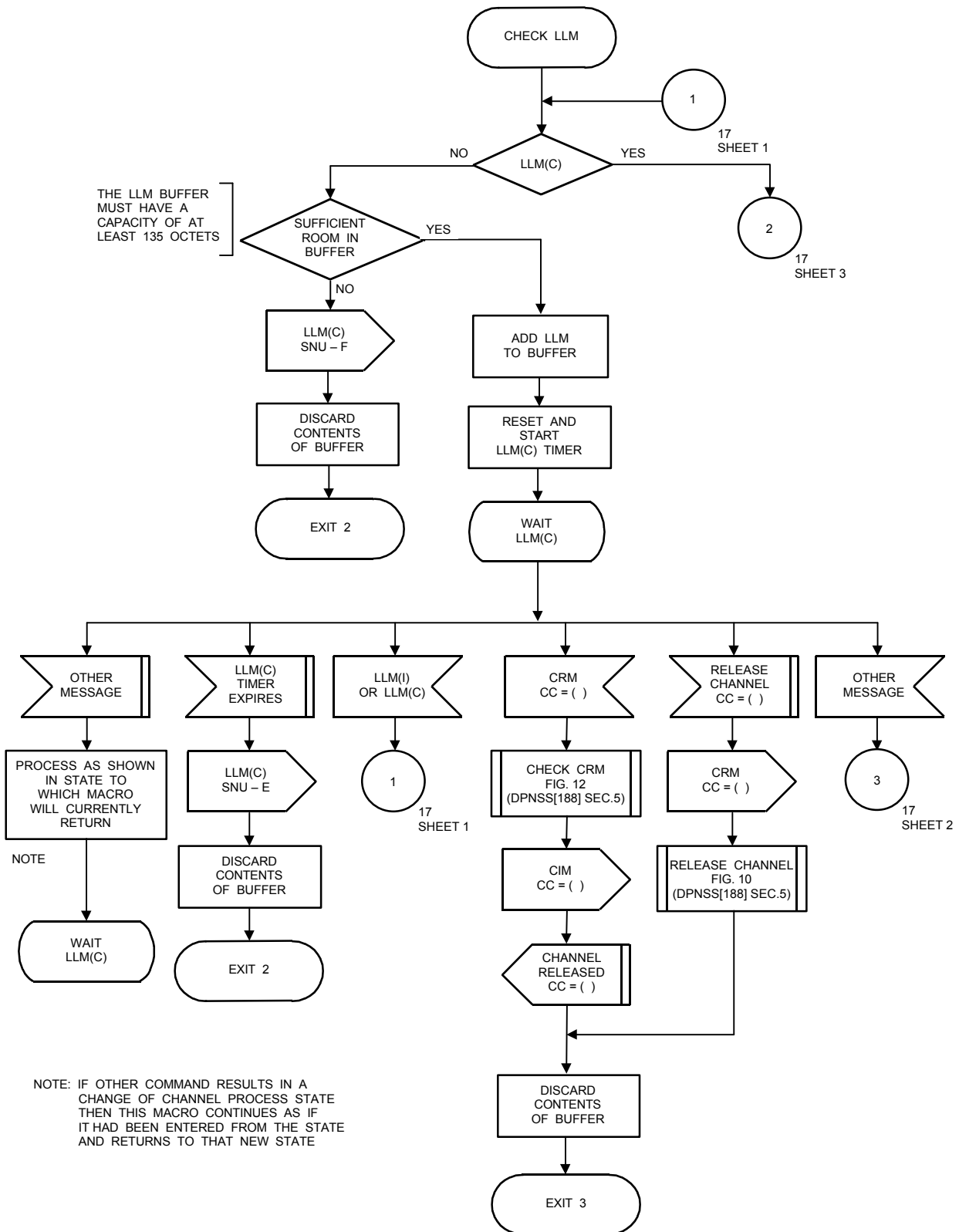

CHANNEL PROCESS: CHECK LLM FOR INCOMPLETE OR UNRECOGNISED CONTENTS
FIG.17 (DPNSS[188] SECTION 5) SHEET 1 OF 3

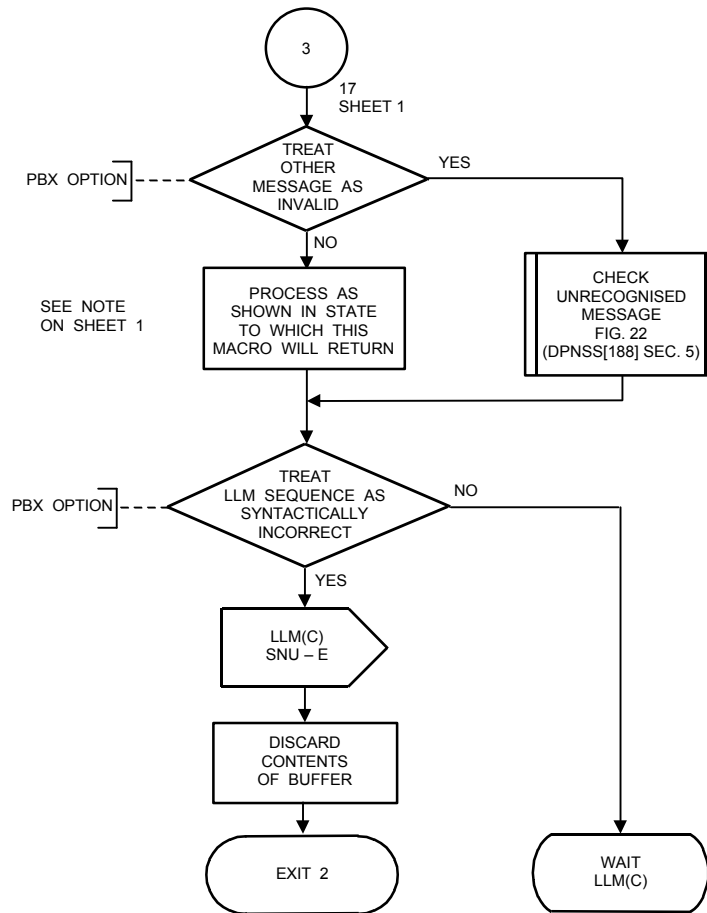

CHANNEL PROCESS: CHECK LLM FOR INCOMPLETE OR UNRECOGNISED CONTENTS
FIG.17 (DPNSS[188] SECTION 5) SHEET 2 OF 3

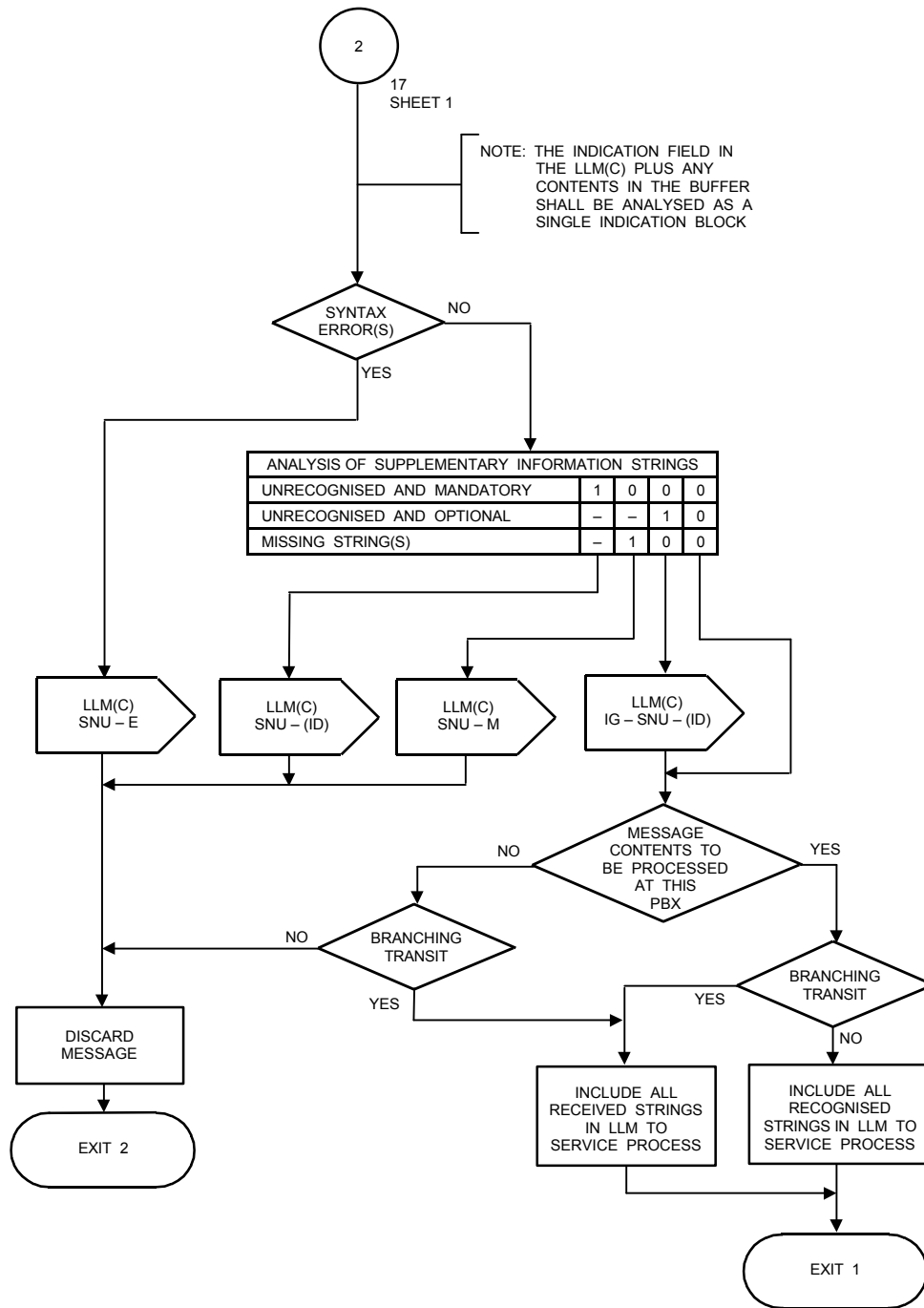

CHANNEL PROCESS: CHECK LLM FOR INCOMPLETE OR UNRECOGNISED CONTENTS
FIG.17 (DPNSS[188] SECTION 5) SHEET 3 OF 3

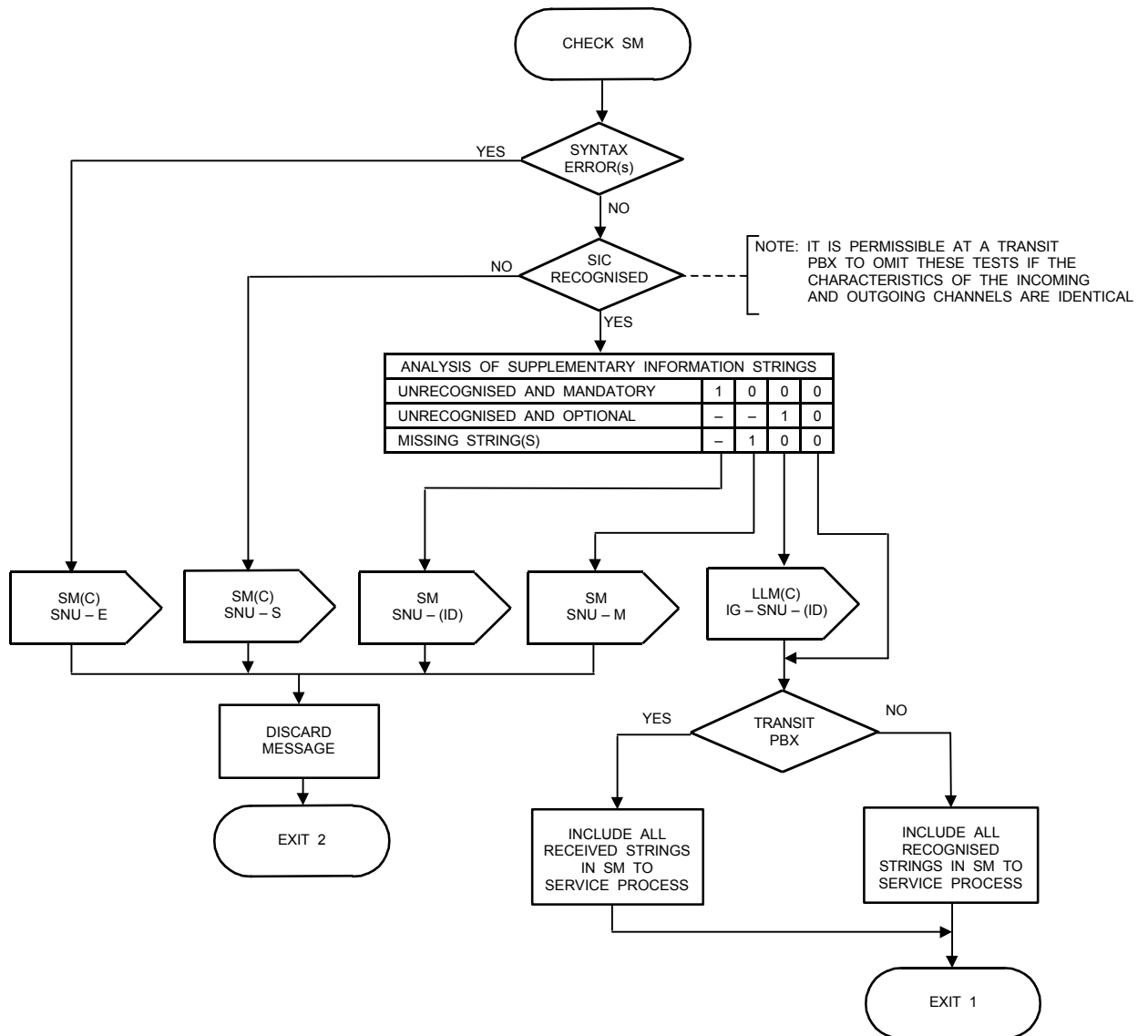

CHANNEL PROCESS: CHECK SM FOR INCOMPLETE OR UNRECOGNISED CONTENTS
FIG.18 (DPNSS[188] SECTION 5)

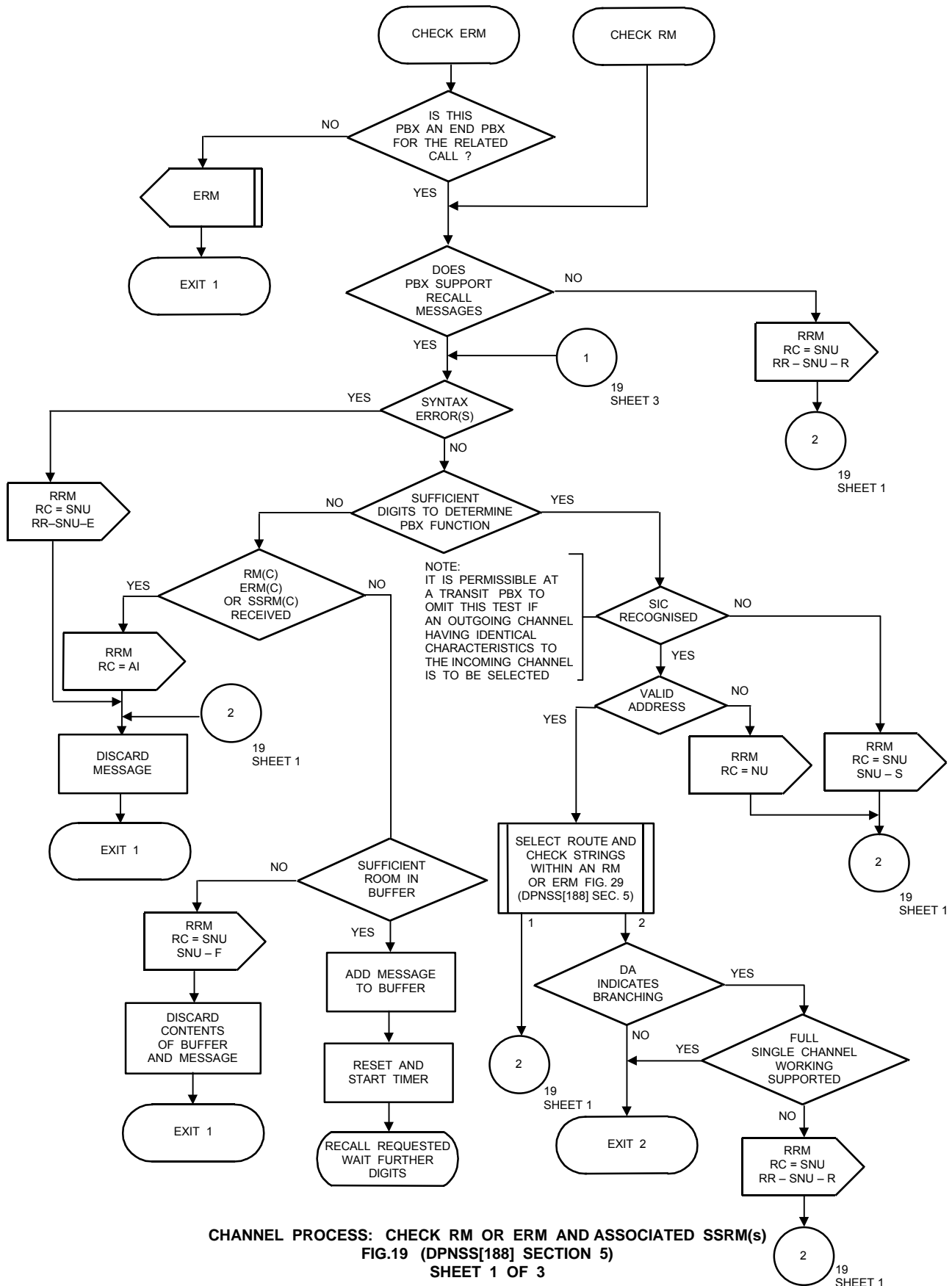

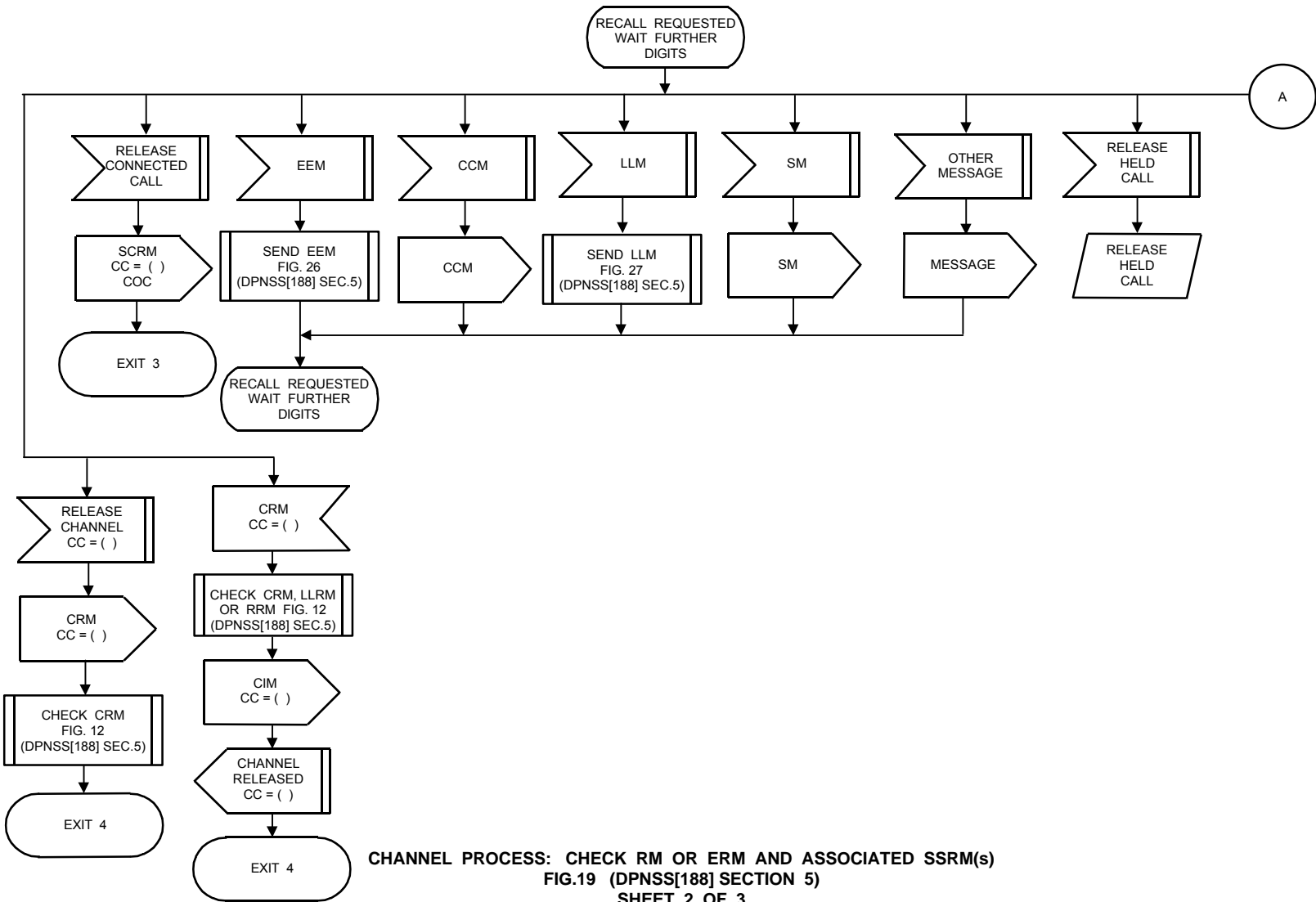

CHANNEL PROCESS: CHECK RM OR ERM AND ASSOCIATED SSRM(s)
FIG.19 (DPNSS[188] SECTION 5)
SHEET 2 OF 3

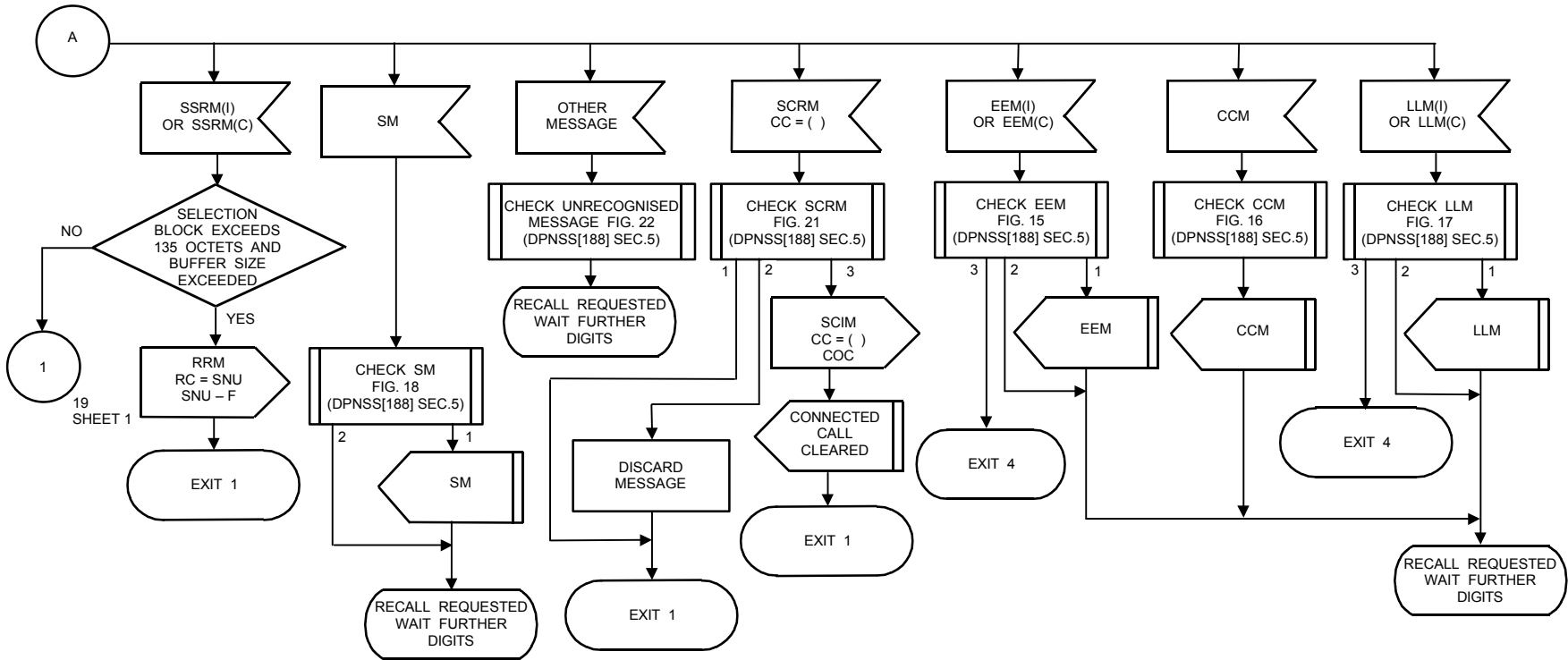

CHANNEL PROCESS: CHECK RM OR ERM AND ASSOCIATED SSRM(s)
FIG.19 (DPNSS[188] SECTION 5)
SHEET 3 OF 3

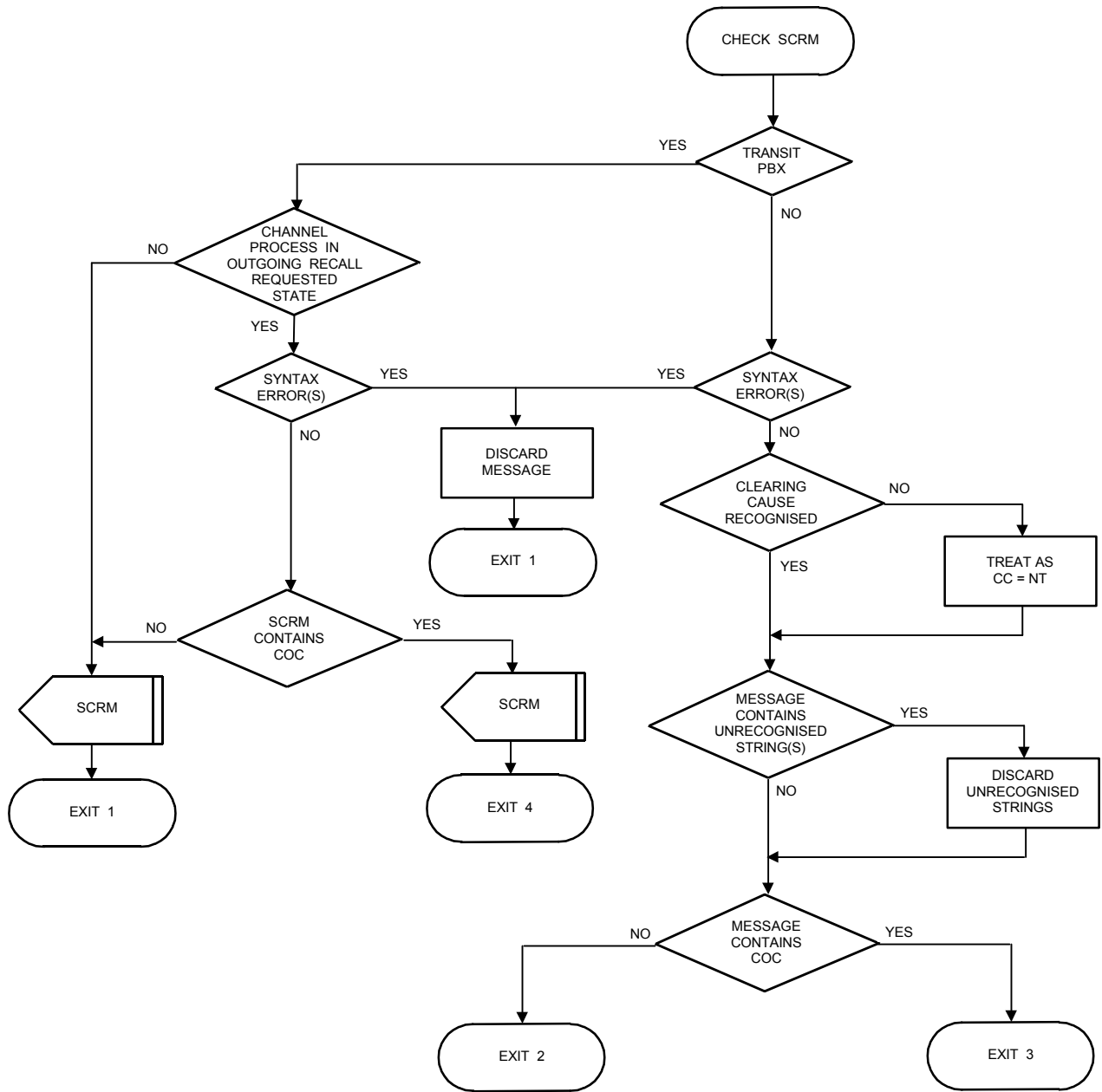

CHANNEL PROCESS: CHECK SCRM FOR INCOMPLETE OR UNRECOGNISED CONTENTS
FIG.21 (DPNSS[188] SECTION 5)

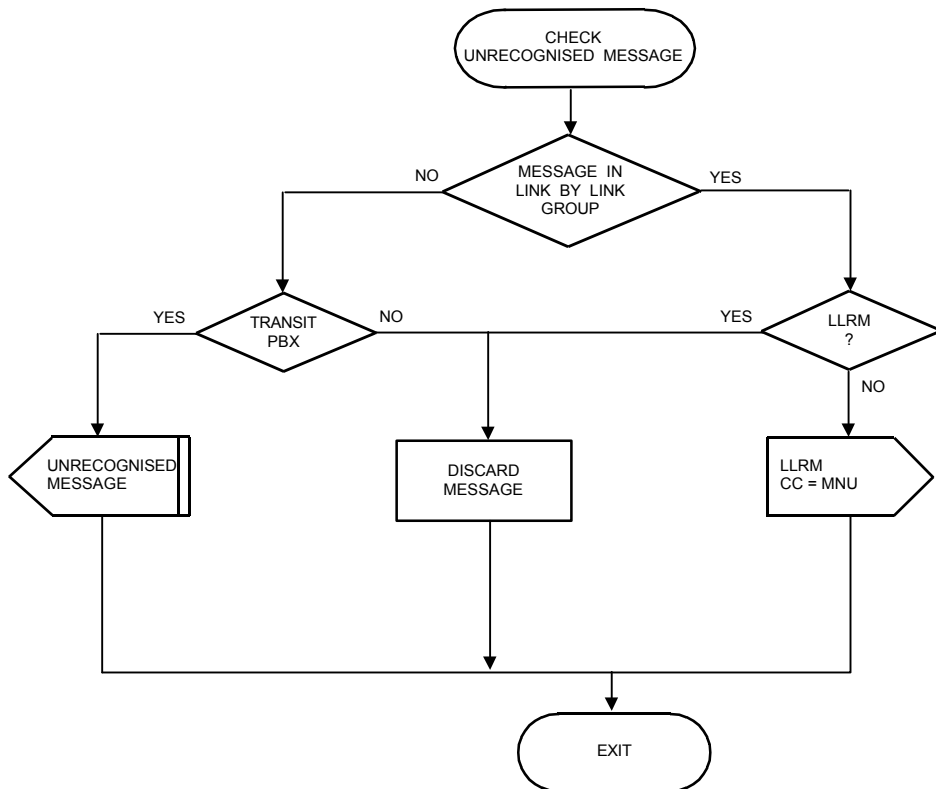

CHANNEL PROCESS: CHECK UNRECOGNISED MESSAGE
FIG.22 (DPNSS[188] SECTION 5)

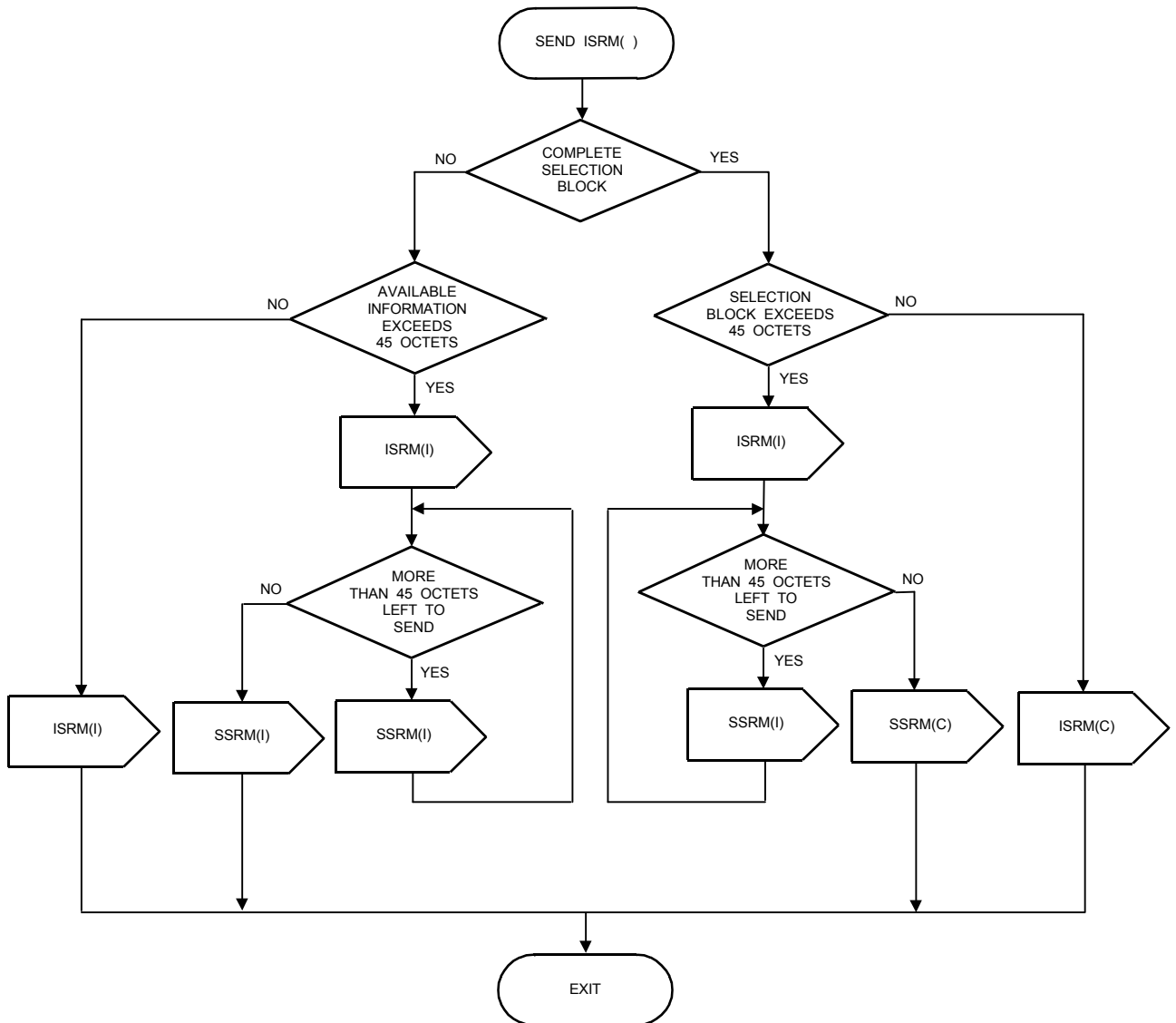

CHANNEL PROCESS: SEND ISRM AND SSRM(s)
FIG.23 (DPNSS[188] SECTION 5)

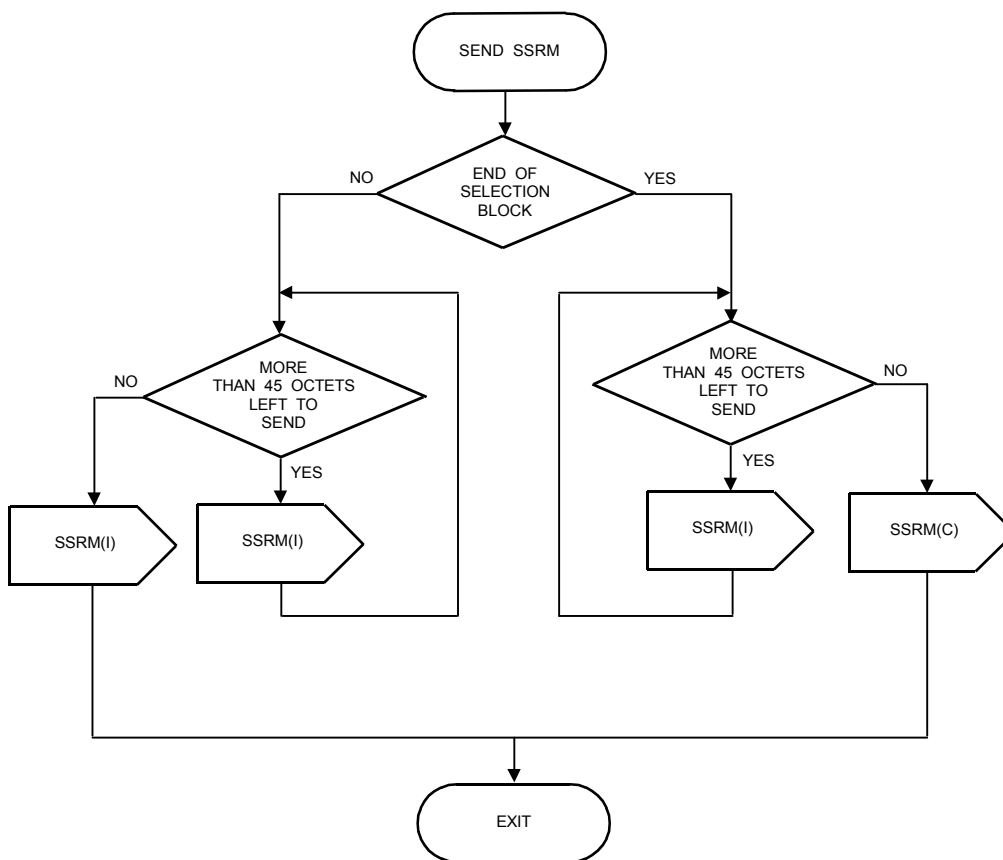

CHANNEL PROCESS: SEND SSRM
FIG.24 (DPNSS[188] SECTION 5)

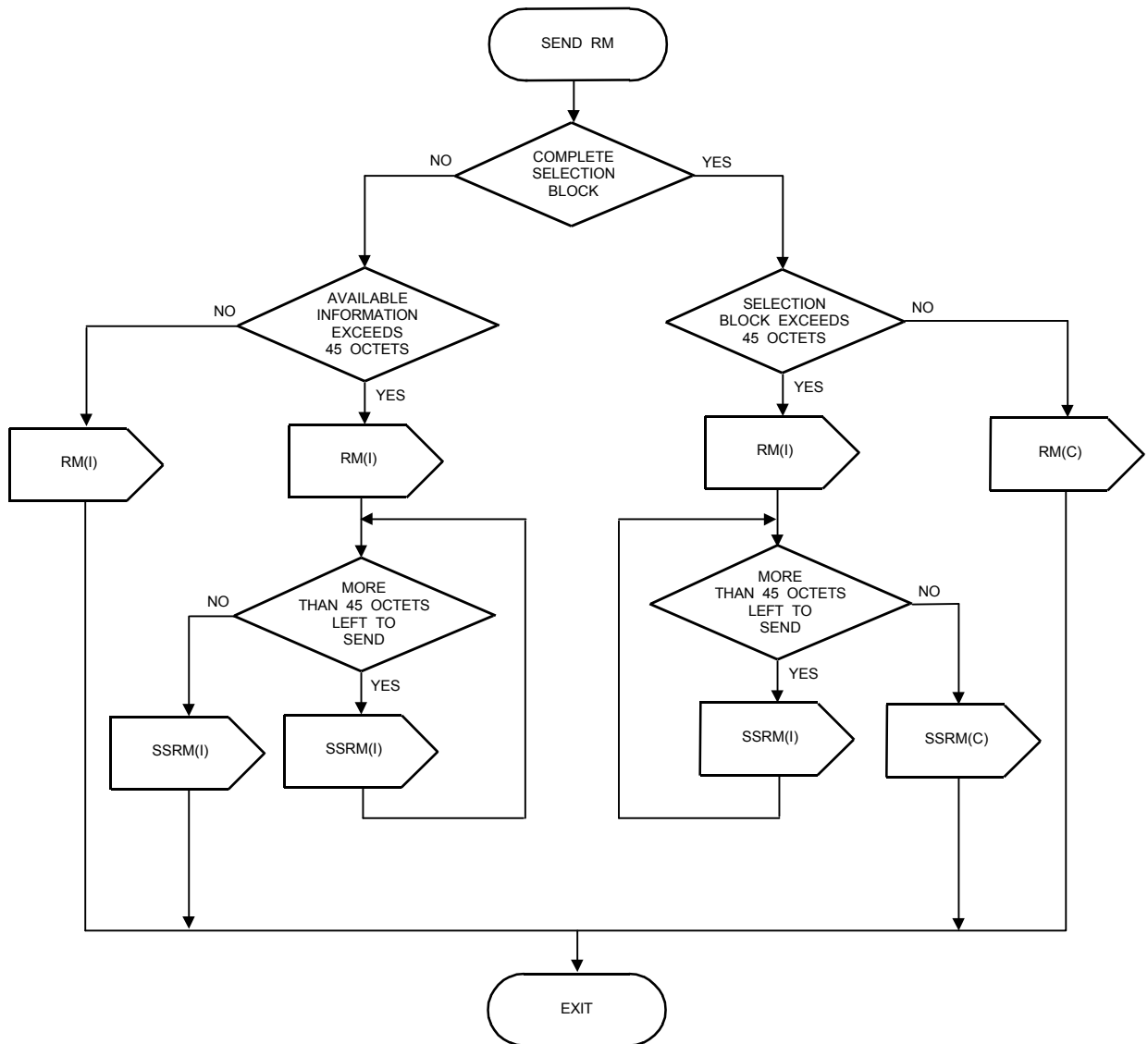

CHANNEL PROCESS: SEND RM AND SSRM(s)
FIG.25 (DPNSS[188] SECTION 5)

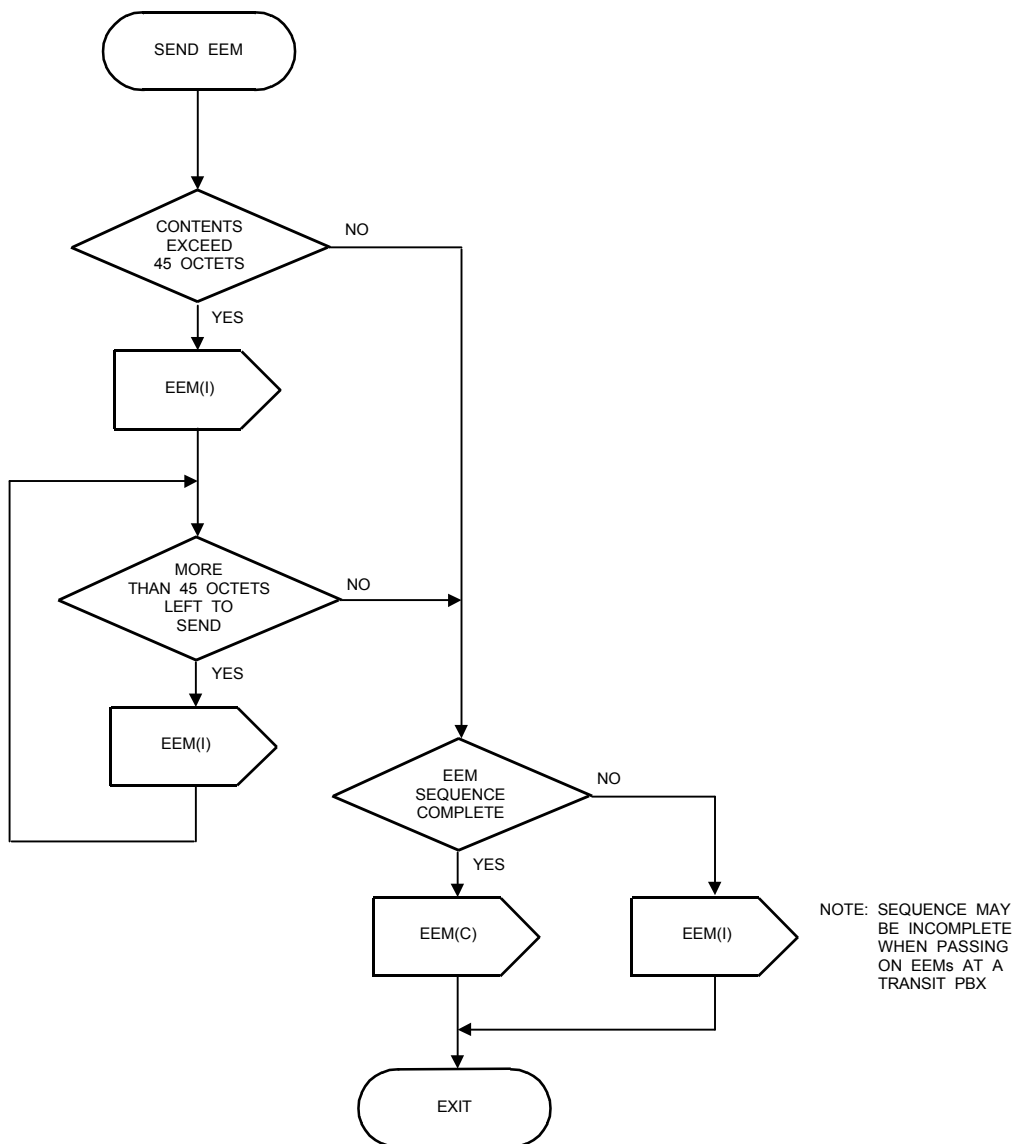

CHANNEL PROCESS: SEND EEM
FIG.26 (DPNSS[188] SECTION 5)

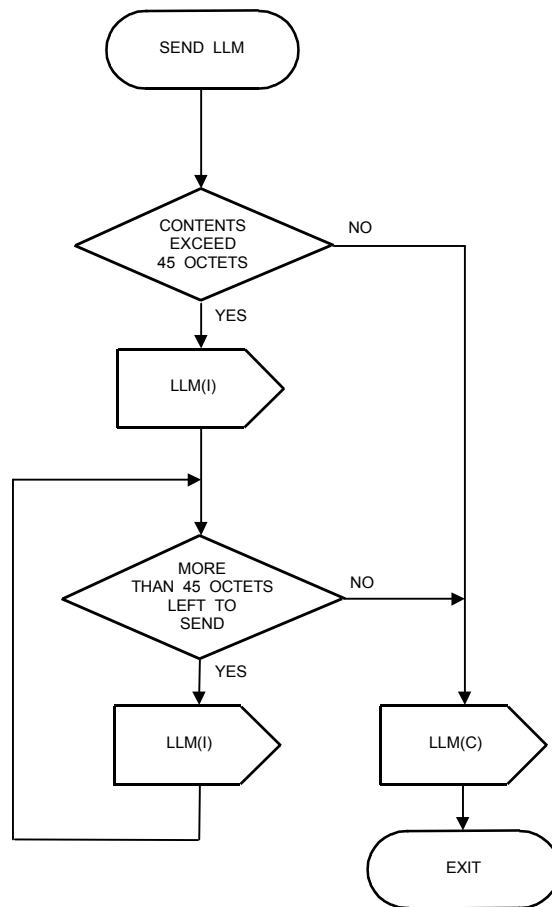

CHANNEL PROCESS: SEND LLM
FIG.27 (DPNSS[188] SECTION 5)

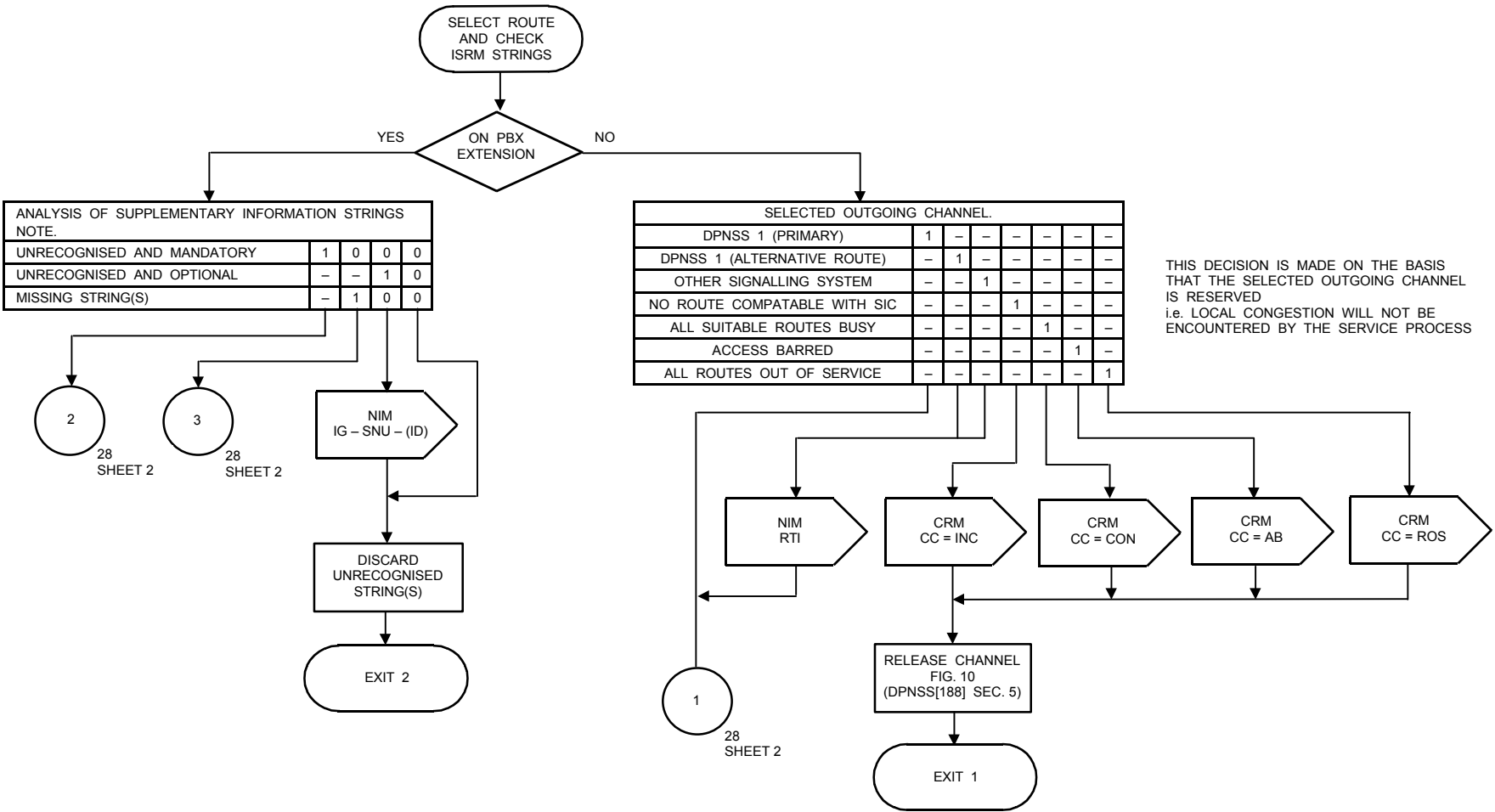

CHANNEL PROCESS: SELECT ROUTE AND CHECK SUPPLEMENTARY INFORMATION STRINGS WITHIN AN ISRM
FIG.28 (DPNSS[188] SECTION 5)
SHEET 1 OF 2

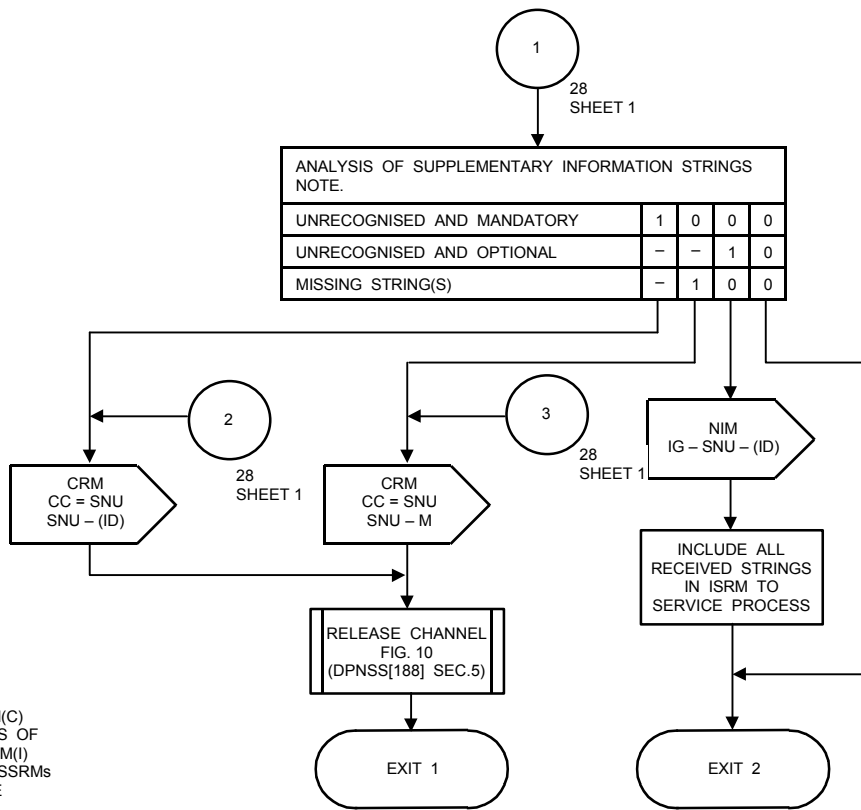

NOTE: THE SELECTION FIELD OF AN ISRM(C) OR THE CONCATENATED CONTENTS OF THE SELECTION FIELDS OF AN ISRM(I) PLUS THE CURRENTLY RECEIVED SSRMs SHALL BE ANALYSED AS A SINGLE SELECTION BLOCK

CHANNEL PROCESS: SELECT ROUTE AND CHECK SUPPLEMENTARY INFORMATION STRINGS WITHIN AN ISRM
FIG.28 (DPNSS[188] SECTION 5)
SHEET 2 OF 2

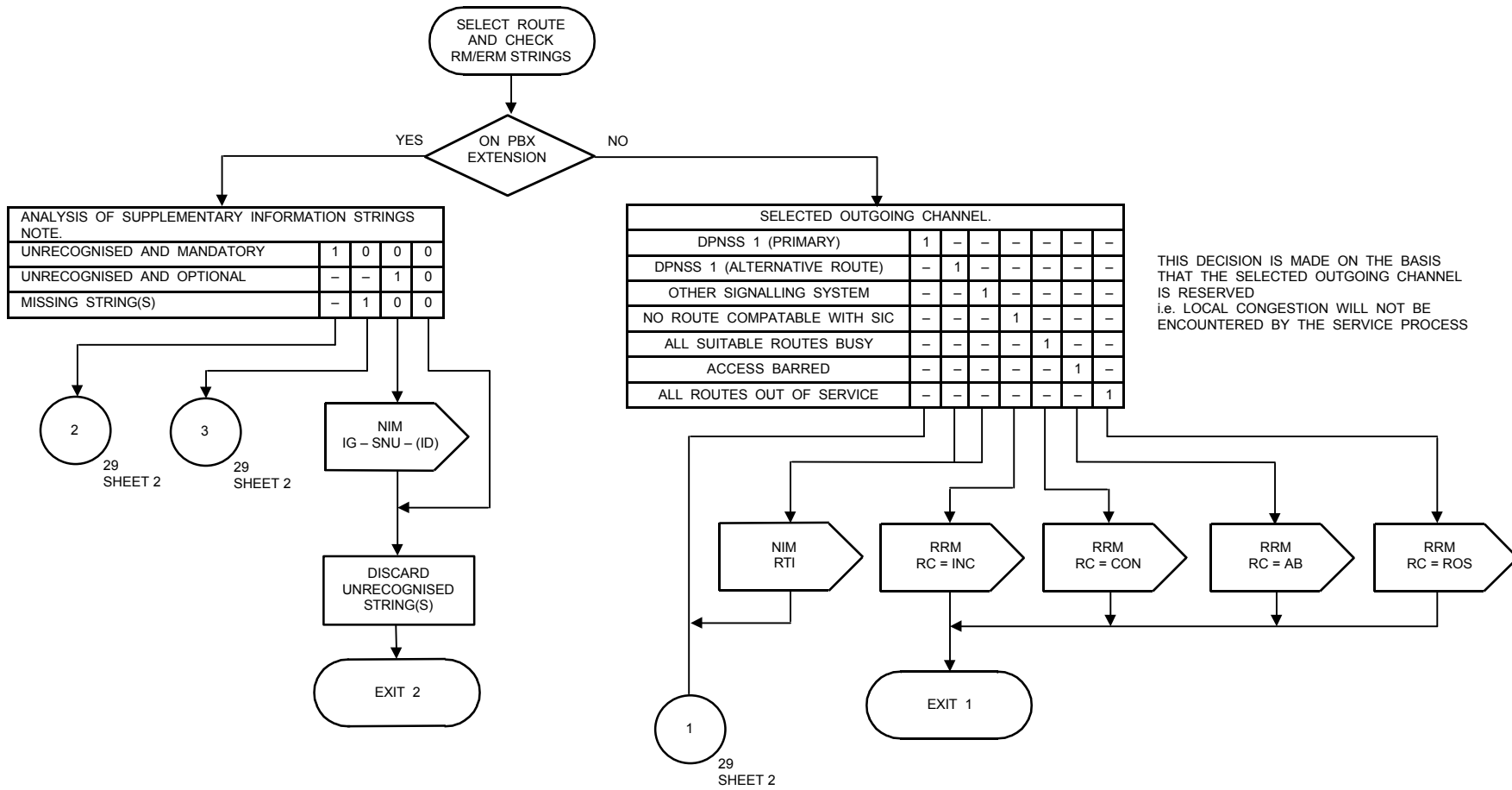

CHANNEL PROCESS: SELECT ROUTE AND CHECK SUPPLEMENTARY INFORMATION STRINGS WITHIN AN RM OR ERM
FIG.29 (DPNSS[188] SECTION 5)
SHEET 1 OF 2

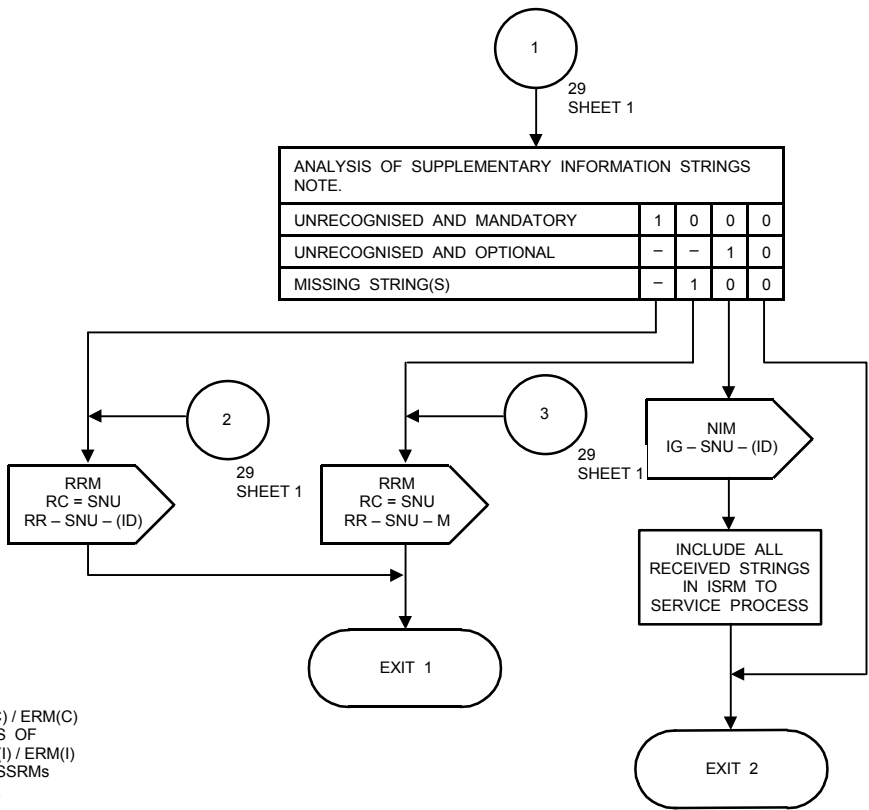

NOTE: THE SELECTION FIELD OF AN RM(C)/ERM(C) OR THE CONCATENATED CONTENTS OF THE SELECTION FIELDS OF AN RM(I)/ERM(I) PLUS THE CURRENTLY RECEIVED SSRMs SHALL BE ANALYSED AS A SINGLE SELECTION BLOCK

CHANNEL PROCESS: SELECT ROUTE AND CHECK SUPPLEMENTARY INFORMATION STRINGS WITHIN AN RM OR ERM
FIG.29 (DPNSS[188] SECTION 5)
SHEET 2 OF 2

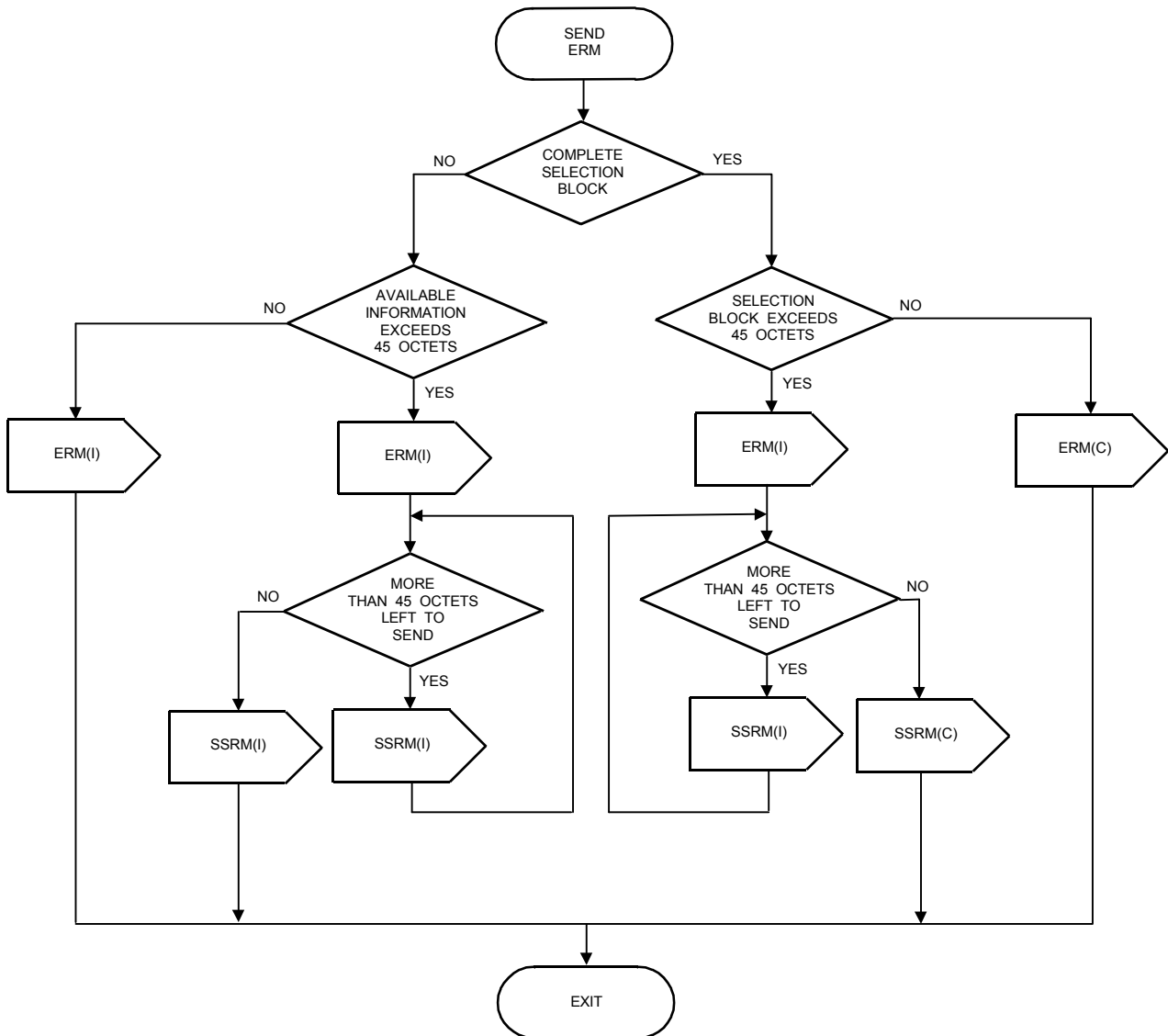

CHANNEL PROCESS: SEND ERM AND SSRM(s)
FIG.30 (DPNSS[188] SECTION 5)

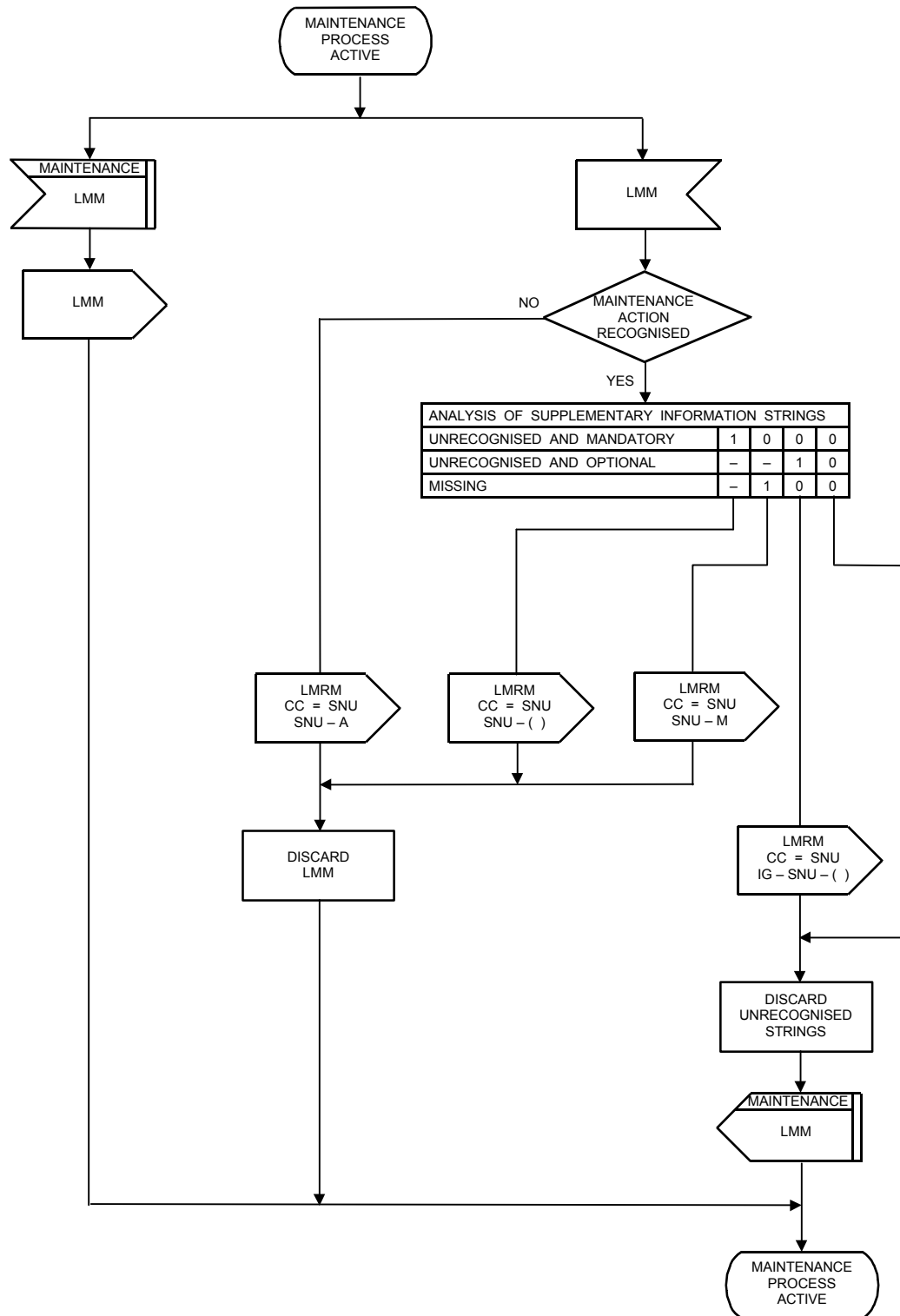

MAINTENANCE CHANNEL PROCESS
FIG.31 (DPNSS[188] SECTION 5)

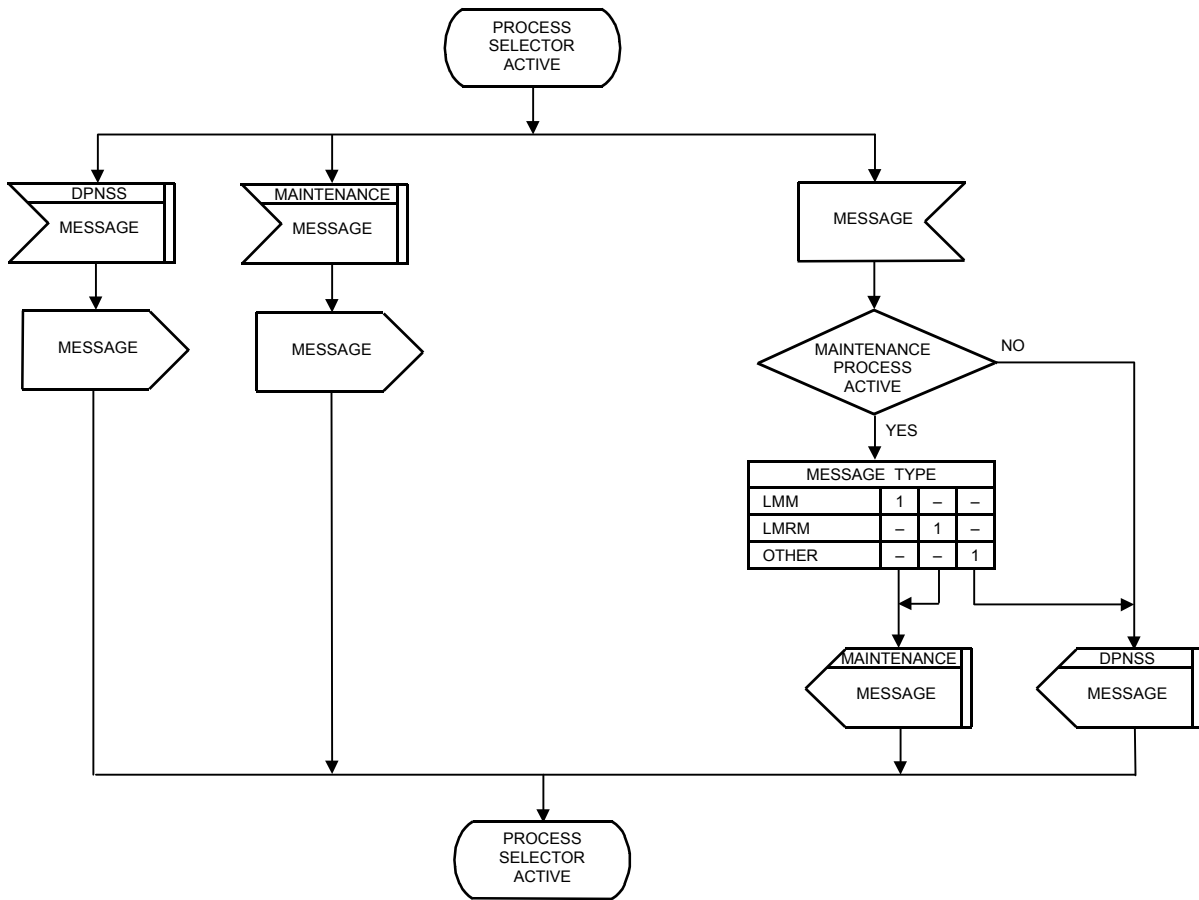

PROCESS SELECTOR
FIG.32 (DPNSS[188] SECTION 5)

DIGITAL PRIVATE NETWORK SIGNALLING SYSTEM NO 1 (DPNSS 1)

SECTION 5

ANNEX 4 : INTERACTION OF SUPPLEMENTARY SERVICES

CONTENTS

1	GENERAL	Page 2
2	CROSS REFERENCE OF SUPPLEMENTARY SERVICE INTERACTIONS	.Page 2
3	RESOLUTION OF SUPPLEMENTARY SERVICE INTERACTIONS	Page 7

HISTORY

Issue 1 - December 1989

Issue 2 - January 1995

Issue 3 - March 2001 - Specification renamed as DPNSS[188]
- Interaction between Redirection and Do Not Disturb added

1 GENERAL

Within a private network of DPNSS 1 PBXs it is probable that Supplementary Service Requests will be made to terminals that already have a Supplementary Service registered or in progress.

Subsection 2 shows possible Supplementary Service interactions and refers to paragraphs within Subsection 3 where the rule for resolution of the clash is specified.

2 CROSS REFERENCE OF SUPPLEMENTARY SERVICE INTERACTIONS

SUPPLEMENTARY SERVICES		PARA
Diversion	Call Back When Free	3.1
	Executive Intrusion	3.2
	Three Party Service	3.3
	Call Offer	3.9
	Call Waiting	3.12
	Redirection	3.24
	Night Service	3.30
	Supplementary Facilities	
	Inhibited	3.45
	Call Back When Next Used	3.58
	Call Distribution	3.60
	Call Park	3.69
	Wait on Busy	3.70
	Call Pick Up	3.78
Three Party Service	Call Back When Free	3.4
	Executive Intrusion	3.5
	Call Offer	3.6
	Call Waiting	3.7
	Diversion	3.3
	Hold	3.13
	Route Optimisation	3.17
	Controlled Diversion	3.22
	Redirection	3.25
	Night Service	3.31
	Swap	3.37
	Supplementary Facilities	
	Inhibited	3.44
	Call Back When Next Used	3.59
Priority Breakdown	3.56	
Call Distribution	3.66	
Wait on Busy	3.71	
Call Pick Up	3.79	

SUPPLEMENTARY SERVICES		PARA
Executive Intrusion	Hold Diversion Three Party Service Call Waiting Route Optimisation Extension Status Call Controlled Diversion Series Call Swap Supplementary Facilities Inhibited Call Distribution Do Not Disturb	3.8 3.2 3.5 3.11 3.15 3.20 3.21 3.27 3.38 3.49 3.65 3.84
Call Offer	Diversion Three Party Service Call Waiting Route Optimisation Controlled Diversion Redirection Supplementary Facilities Inhibited Call Distribution Do Not Disturb	3.9 3.6 3.10 3.18 3.23 3.40 3.48 3.67 3.85
Call Waiting	Redirection Three Party Service Executive Intrusion Call Offer Diversion Route Optimisation Call Back When Free Supplementary Facilities Inhibited Priority Breakdown Wait on Busy	3.41 3.7 3.11 3.10 3.12 3.19 3.39 3.47 3.55 3.72
Hold	Executive Intrusion Three Party Service Route Optimisation Series Call Swap Supplementary Facilities Inhibited Priority Breakdown	3.8 3.13 3.16 3.28 3.36 3.43 3.53

SUPPLEMENTARY SERVICES		PARA
Call Back When Free	Diversion Three Party Service Call Waiting Supplementary Facilities Inhibited Call Back When Next Used Call Distribution Call Pick Up	3.1 3.4 3.39 3.46 3.57 3.63 3.82
Route Optimisation	Swap Executive Intrusion Hold Three Party Service Call Offer Call Waiting Three Party Takeover Series Call Priority Breakdown Call Distribution Wait on Busy	3.14 3.15 3.16 3.17 3.18 3.19 3.26 3.29 3.54 3.62 3.73
Swap	Route Optimisation Hold Three Party Service Executive Intrusion Supplementary Facilities Inhibited Priority Breakdown	3.14 3.36 3.37 3.38 3.50 3.52
Extension Status	Executive Intrusion Night Service	3.20 3.32
Controlled Diversion	Executive Intrusion Three Party Service Call Offer Night Service Wait on Busy	3.21 3.22 3.23 3.33 3.74
Redirection	Diversion Three Party Service Night Service Call Offer Call Waiting Supplementary Facilities Inhibited Wait on Busy Call Pick Up Do Not Disturb	3.24 3.25 3.34 3.40 3.41 3.51 3.75 3.81 3.87

SUPPLEMENTARY SERVICES		PARA
Three Party Takeover	Route Optimisation	3.26
Series Call	Executive Intrusion	3.27
	Hold	3.28
	Route Optimisation	3.29
	Night Service	3.35
Night Service	Diversion	3.30
	Three Party Service	3.31
	Extension Status Call	3.32
	Controlled Diversion	3.33
	Redirection	3.34
	Series Call	3.35
	Call Distribution	3.61
	Call Pick Up	3.80
Traffic Channel Maintenance	Simple Telephony Call	3.42
Simple Telephony Call	Traffic Channel Maintenance	3.42
Supplementary Facilities Inhibited	Hold	3.43
	Three Party Service	3.44
	Diversion	3.45
	Call Back When Free	3.46
	Call Waiting	3.47
	Call Offer	3.48
	Executive Intrusion	3.49
	Swap	3.50
	Redirection	3.51
Wait on Busy	3.76	
Priority Breakdown	Swap	3.52
	Hold	3.53
	Route Optimisation	3.54
	Call Waiting	3.55
	Three Party Service	3.56
Call Back When Next Used	Call Back When Free	3.57
	Diversion	3.58
	Three Party Service	3.59
	Call Distribution	3.64
	Call Pick Up	3.83
Loop Avoidance	Call Distribution	3.68
Call Park	Diversion	3.69

SUPPLEMENTARY SERVICES		PARA
Call Distribution	Diversion Night Service Route Optimisation Call Back When Free Call Back When Next Used Executive Intrusion Three Party Call Offer Loop Avoidance Wait on Busy	3.60 3.61 3.62 3.63 3.64 3.65 3.66 3.67 3.68 3.77
Wait On Busy	Diversion Three Party Service Call Waiting Route Optimisation Controlled Diversion Redirection Supplementary Facilities Inhibited Call Distribution Do Not Disturb	3.70 3.71 3.72 3.73 3.74 3.75 3.76 3.77 3.86
Call Pick-up Service	Diversion Three Party Service Night Service Redirection Call Back When Free Call Back When Next Used	3.78 3.79 3.80 3.81 3.82 3.83
Do Not Disturb	Executive Intrusion Call Offer Wait on Busy Redirection	3.84 3.85 3.86 3.87

3 RESOLUTION OF SUPPLEMENTARY SERVICE INTERACTIONS

3.1 CALL BACK WHEN FREE - DIVERSION

3.1.1 Call Back When Free Request on Diverted Calls

3.1.1.1 Divert - Immediate

If a call that has followed Divert Immediate finds that the nominated extension is engaged, the caller may request Call Back When Free.

Under these circumstances the Originating PBX should make the request in the normal way but to the nominated extension.

The Call Back When Free request shall include DVG-I in the ISRM.

If a Call Back When Free Request is received for an extension that has Divert Immediate registered and the ISRM does not contain DIV-BY the PBX shall either:

- if diverting On PBX, register the CBWF request at the nominated extension and return DVD-I in the CRM, or
- if diverting Off PBX, reject the CBWF request by returning a CRM with Clearing Cause: NT and String DVT-I. A CIM shall be expected in response.

The Originating PBX, on receipt of a CRM containing DVT-I, shall remake the "Call Back When Free Request" to the nominated extension. The new Call Back When Free request shall include DVG-I in the ISRM.

3.1.1.2 Divert - On Busy

If a call that has followed Divert On Busy finds the nominated extension is also engaged the caller may request Call Back When Free.

Under these circumstances the Originating PBX makes the Call Back When Free request to the originally called extension.

If a Call Back When Free request is received by an extension that has Divert - On Busy registered it shall by-pass diversion.

3.1.2 Call Back When Free - Free Notification Encounters Diversion

If a Call Back When Free - Free Notification is received by an extension that has Divert Immediate, Divert on Busy or Divert on No Reply registered it shall be accepted and the service processed as if diversion was not registered.

3.1.3 Call Back When Free - Call Set-Up Encounters Diversion

3.1.3.1 Divert - Immediate or On Busy

If a Call Back When Free - Call Set-Up is received by an extension that has either Divert Immediate or Divert on Busy registered the diversion shall be by-passed and the call back call shall be handled in the normal way.

3.1.3.2 Divert - On No Reply

If a Call Back When Free - Call Set-up is received by an extension that has Divert on No Reply registered and after completion of the call back call but before answer the Divert on No Reply time out expires, diversion will take place in the normal way.

3.1.4 Call Back When Free - Cancel Encounters Diversion

If a Call Back When Free - Cancel is received by an extension that has Divert Immediate, Divert on Busy or Divert on No Reply the cancellation shall be processed as if the diversion was not registered.

3.1.5 Diversion Registration - Call Back When Free

Diversion Registration shall not be affected by any CBWF requests which have been made by or received by the extension concerned, and shall have no effect on those requests.

3.2 EXECUTIVE INTRUSION - DIVERSION

3.2.1 Executive Intrusion Request (without Prior Validation) on a Diverted Call

3.2.1.1 Divert Immediate

If a call that has been Diverted Immediate finds that the nominated extension is engaged, the caller may request Executive Intrusion.

Under these circumstances the Originating PBX shall make a new call to the nominated extension and include EI-R and DVG-I in the ISRM.

3.2.1.2 Divert On Busy

If a call that has been Diverted on Busy finds the nominated extension is also engaged the caller may request Executive Intrusion.

Under these circumstances the Originating PBX shall make a new call to the original extension and include EI-R in the ISRM.

3.2.2 Executive Intrusion Request (Without Prior Validation) Encounters Diversion

3.2.2.1 Divert Immediate

If an Executive Intrusion Request is received by an extension that has Divert Immediate to an extension on another PBX registered, it shall ignore the request and return DVT-I in the NAM in the normal way. The Originating PBX shall make the diversion call to the new extension and include both DVG-I and EI-R in the ISRM or RM.

If the Diversion Immediate is to an extension within the Terminating PBX, the EI-R shall act upon the nominated extension and DVD-I shall be added to the returned NAM or CRM.

If an Executive Intrusion Request containing DIV-BY is received by an extension that has Divert Immediate registered, the diversion shall be bypassed.

3.2.2.2 Divert on Busy

If an Executive Intrusion Request is received by an extension that has Divert on Busy registered diversion shall be by-passed.

3.2.2.3 Divert on No Reply

If an Executive Intrusion Request (EI-R) is received by an extension that has Divert on No-Reply registered, the action taken will depend on whether the extension is busy or free:

- if the extension is free, normal Divert on No-Reply action shall be taken. On receipt of the EEM containing DVT-R the Originating PBX shall not include EI-R in the ISRM or RM of the diverting call;
- if the extension is busy the EI-R request shall be handled as if the diversion was not registered.

3.2.3 Executive Intrusion Request (with Prior Validation) Encounters Diversion

3.2.3.1 Divert Immediate

If a call with Executive Intrusion-Prior Validation (EI-PVR) is received by an extension which has Divert Immediate to an extension on another PBX registered, the Terminating PBX shall ignore the EI-PVR and return a NAM containing DVT-I in the normal way.

The Originating PBX on receipt of the NAM shall make the diversion call to the new extension and include both DVG-I and EI-PVR in the ISRM or RM.

If the Diversion Immediate is to an extension within the Terminating PBX, the EI-PVR shall act upon the nominated extension and DVD-I shall be added to the returned NAM or CRM.

If the EI-PVR request contains DIV-BY the diversion shall be by-passed.

3.2.3.2 Divert On Busy

If a call with Executive Intrusion Prior Validation (EI-PVR) is received by an extension that is busy and has Divert on Busy to an extension on another PBX registered, the Terminating PBX shall return a NAM containing DVT-B. If the busy extension is intrudable the NAM shall also include ACK.

The Originating PBX on receipt of the NAM may make the diversion call to the new extension and include DVG-B and EI-PVR in the ISRM or RM. Alternatively, if the NAM contained ACK, the Originating PBX/user may decide to intrude, in which case an EEM containing EI-R shall be sent.

If the Diversion On Busy is to an extension within the Terminating PBX, the EI-PVR shall act upon the nominated extension and DVD-B shall be added to the returned NAM or CRM.

If the EI-PVR request contains DIV-BY, the diversion shall be by-passed.

3.2.3.3 Divert On No-Reply

If a call with Executive Intrusion Prior Validation (EI-PVR) is received by an extension that has Divert on No-Reply registered, the action taken will depend on whether the extension is busy or free:

- if the extension is free, normal Divert on No-Reply action shall be taken. On receipt of the EEM containing DVT-R the Originating PBX shall not include EI-PVR in the ISRM or RM of the diverting call.
- if the extension is busy the EI-PVR request shall be handled as if the diversion was not registered.

3.3 THREE PARTY SERVICE - DIVERSION

3.3.1 Enquiry Call Encounters Diversion

3.3.1.1 Divert-Immediate

The behaviour of a Terminating PBX on encountering Diversion Immediate is unaffected by the presence of an ENQ String in the ISRM.

The Originating PBX, on receipt of a NAM containing DVT-I shall remake the Enquiry Call to the new address:

3.3.1.1.1 Original Enquiry Call via a New Channel

If the original Enquiry Call was via a different channel from the Held Call, the diverted Enquiry Call may be established:

- on a new channel by sending an ISRM containing DVG-I and ENQ. The original Enquiry Call shall be cleared by sending a CRM. A CIM shall be expected in response;
- on the existing Enquiry Channel by sending an RM containing DVG-I and ENQ. Note that an RM shall not be sent along the Held Channel.

3.3.1.1.2 Original Enquiry Call via a Shared Channel

If the original Enquiry Call was via the same channel as the Held Call, the diverting Enquiry Call may, depending on the Destination Address and PBX capability, be established:

- on a new channel by sending an ISRM containing DVG-I and ENQ. The original Enquiry Call is cleared by sending an SCRIM containing COC and expecting an SCIM in response. This PBX takes over the role of Branching PBX for the Three Party Service.
- on the existing shared channel by sending an RM containing DVG-I and Single Channel Enquiry (SCE).

On receipt of an RM containing DVG-I and SCE a PBX that is acting as a transit for the original Enquiry Call shall route the new call in accordance with the requirements of this paragraph (3.3.1.1.2).

If the PBX is acting as a Branching PBX for the original Enquiry Call it shall route the new call in accordance with the requirements of paragraph 3.3.1.1.1.

3.3.1.2 Divert - On Busy

The procedure when an Enquiry Call encounters Divert on Busy is the same as for Divert Immediate except DVT-B and DVG-B are used in place of DVT-I and DVG-I.

3.3.1.3 Divert - On No Reply

If an Enquiry Call is received by an extension that has Divert on No Reply registered and the Divert on No Reply time out expires an EEM containing DVT-R is sent to the Originating PBX in the normal way.

On receipt of the EEM the Originating PBX remakes the call in the same way as described above for Divert Immediate except that:

- DVT-R and DVG-R are used in place of DVT-I and DVG-I;
- The original Enquiry Call is maintained in the ringing state until a NAM is received by the Branching PBX from the "diverted to" PBX (See SECTION 11, paragraph 2.3.9.4).

3.3.2 Transferred Call Encounters Diversion on No Reply

When transfer occurs before the enquired to extension has answered, the extension may have Diversion on No Reply registered. If the timeout for no-reply expires, normal Diversion on No Reply procedures apply.

3.3.3 Diverted Call Transferred

If an enquiry call that has been diverted is transferred before it is answered, the identity of the originally called party may be sent by the nominated party's PBX to the held party's PBX. This is achieved by including the String OCP (Originally Called Party) in the EEM sent by the nominated party's PBX in response to the received EEM containing TRFD.

The Parameter of the OCP String shall be the address contained in the DVG-I/B/R String received at the nominated party's PBX in the diverted call ISRM.

The OCP Parameter may be used to pass on the address of the originally called party, if required, in any subsequent signalling sequences such as a further diversion on no reply.

3.4 THREE PARTY - CALL BACK WHEN FREE

3.4.1 Enquiry Call Requests Call Back When Free

If an Enquiry Call finds that the required extension is busy, the caller may request Call Back When Free.

The Call Back When Free Request is made by means of a Virtual Call in the normal way. No additional Strings are included in the ISRM to indicate that the requesting party is making an Enquiry Call.

3.4.2 Call Back When Free - Call Set Up as an Enquiry Call

If a Call Back When Free - Free Notification is received by a busy extension, it may be possible to indicate the fact to the user and permit the user to place the existing call on hold and accept the call-back. The Call Back When Free - Call Set Up shall be established as an Enquiry Call using an ISRM containing ENQ and CBWF-CSUD or an RM containing SCE and CBWF-CSUD. The Terminating PBX shall behave as for a normal CBWF-Call Set Up but may apply a special calling signal.

3.5 THREE PARTY SERVICE - EXECUTIVE INTRUSION

3.5.1 Enquiry Call Requests Executive Intrusion (without Prior Validation)

If an Enquiry Call encounters a busy extension the caller may request Executive Intrusion. Under these circumstances the Originating PBX shall remake the Enquiry Call and include EI-R in the ISRM ENQ or RM SCE. The request shall be handled by the Terminating PBX in the same way as a Simple Call with Executive Intrusion, except that a special calling signal may be applied.

3.5.2 Enquiry Call Requests Executive Intrusion (with Prior Validation)

The Prior Validation String EI-PVR may be included in an Enquiry Call ISRM or RM. It shall be handled by the Terminating PBX in the same way as a Simple Call with Executive Intrusion with Prior Validation, except that a special calling signal may be applied.

3.5.3 Executive Intrusion on Three Party Service

SF2 recommends that any party involved in Three Party Service should be non-intrudable. DPNSS 1 provides the means by which a PBX can prevent intrusion by allocating an IPL of 3 to the controlling party. This would be used when the controlling party receives an intrusion request (with or without Prior Validation) or when an IPL request is received from either the connected party or the held party. Whether or not a PBX prevents intrusion on a Three Party Call depends on its design and on the customer's requirements.

After Add-on, an intrusion request may be rejected by the wanted party's PBX. If not, an EEM containing IPL-R will be sent to the Conference PBX. The Conference PBX may either respond immediately with an IPL of 3 or pass the EEM on to each of the other parties' PBXs. When responses have been received from those PBXs, the Conference PBX shall use the higher IPL in its response to the wanted PBX.

3.5.4 Enquiry Call Establishment during Intrusion

In order to comply with SF2 recommendations, a PBX should reject an enquiry request by the wanted party while intrusion is taking place.

The DPNSS 1 Hold Service offers the possibility of preventing Hold and hence preventing enquiry by the unwanted party. See Paragraph 3.8.2.

3.6 THREE PARTY SERVICE - CALL OFFER

3.6.1 Enquiry Call Requests Call Offer

If an Enquiry Call encounters a busy extension the caller may request Call Offer. Under these circumstances the Originating PBX shall remake the Enquiry Call and include CO in the ISRM containing ENQ or RM containing SCE. The request shall be handled by the Terminating PBX as a normal Call Offer request, except that a special calling signal may be applied.

3.6.2 Transfer During Call Offer

After Call Offer has been invoked on an Enquiry Call the Controlling Party may transfer. On receipt of an EEM containing TRFD the Enquired to PBX shall include String CW (in addition to CLI and CLC-ORD) in the EEM sent to the PBX to which it is now connected.

3.7 THREE PARTY SERVICE - CALL WAITING

3.7.1 Enquiry Call encounters Call Waiting

The Call Waiting service may be applied to an incoming Enquiry Call in the same way that it is applied to a Simple Call.

3.7.2 Transfer During Call Waiting

After Call Waiting has been invoked on an Enquiry call the controlling party may transfer. On receipt of an EEM containing TRFD the Enquired to PBX shall include String CW (in addition to CLI and CLC-ORD) in the EEM sent to the PBX to which it is now connected.

3.8 EXECUTIVE INTRUSION - HOLD

3.8.1 Intrusion on a Held Party

In order to comply with the SF2 recommendations concerning intrusion in a three party situation, a PBX may treat a party that has been placed on hold as non-intrudable by allocating that party an IPL of 3.

3.8.2 Hold Request during Intrusion

In order to comply with the SF2 recommendation concerning intrusion in a three-party situation, a PBX may reject an EEM containing HOLD-REQ if intrusion is taking place.

3.9 CALL OFFER - DIVERSION

3.9.1 Call Offer Request on a Diverted Call

3.9.1.1 Divert Immediate

If a call that has been Diverted Immediate finds that the nominated extension is busy, the caller may request Call Offer.

Under these circumstances the Originating PBX shall make a new call to the nominated extension and include CO and DVG-I in the ISRM.

3.9.1.2 Divert On Busy

If a call that has been Diverted on Busy finds that the nominated extension is also busy, the caller may request Call Offer.

Under these circumstances the Originating PBX shall make a new call to the original extension and include CO in the ISRM.

3.9.1.3 Divert on No Reply

As a call which has been diverted on no reply cannot be presented to a busy extension, there is no interaction with Call Offer.

3.9.2 Call Offer Request encounters Diversion

3.9.2.1 Divert Immediate

If a Call Offer Request is received by an extension that has Divert Immediate to an extension on another PBX registered, it shall ignore the request and return DVT-I in the NAM in the normal way. The Originating PBX shall make the diversion call to the new extension and include both DVG-I and CO in the ISRM or RM.

If the Divert Immediate is to an extension within the Terminating PBX, the Call Offer Request shall act upon the nominated extension and DVD-I shall be added to the returned NAM or CRM.

If a Call Offer Request containing DIV-BY is received by an extension that has Divert Immediate registered, the diversion shall be bypassed.

3.9.2.2 Divert on Busy

If a Call Offer Request is received by an extension that has Divert on Busy registered the diversion shall be bypassed.

3.9.2.3 Divert on No Reply

If a Call Offer Request is received by an extension that has Divert on No-Reply registered, the action taken will depend on whether the extension is busy or free:

- if the extension is free, normal Divert on No-Reply action shall be taken. On receipt of the EEM containing DVT-R the Originating PBX shall not include CO in the ISRM or RM of the diverting call;
- if the extension is busy the Call Offer Request shall be handled as if the diversion was not registered.

3.10 CALL WAITING - CALL OFFER

3.10.1 Call Offer Request Encounters Call Waiting

If a Call Offer Request encounters an extension with Call Waiting registered, the Call Offer Request is ignored and normal Call Waiting action is taken.

3.11 CALL WAITING - EXECUTIVE INTRUSION

3.11.1 Executive Intrusion Request (without Prior Validation) Encounters Call Waiting

If an Executive Intrusion Request without Prior Validation is received at an extension which has Call Waiting registered, Call Waiting is overridden.

3.11.2 Executive Intrusion Request (with Prior Validation) Encounters Call Waiting

If an Executive Intrusion Request with Prior Validation is received at an extension which has Call Waiting registered, if the extension is busy Call Waiting action shall be taken.

If the extension is also intrudable the NAM shall contain ACK in addition to CW. If before the waiting call is accepted, the calling party requests intrusion, an EEM containing EI-R shall be sent.

3.12 CALL WAITING - DIVERSION

3.12.1 Diverted Immediate or Diverted On Busy Call Encounters Call Waiting

If a call that has been Diverted Immediate or on Busy encounters an extension that is busy and has Call Waiting registered, Call Waiting shall proceed in the normal manner.

3.12.2 Diverted - On No Reply Call Encounters Call Waiting

If a call that is being Diverted on No Reply encounters a busy extension with Call Waiting registered, Call Waiting shall be ignored and a CRM with Clearing Cause: BY returned. A CIM shall be expected in response.

3.13 HOLD SERVICE - THREE PARTY SERVICE

3.13.1 Hold After Add-on

Following Add-On any of the parties may place the conference on hold.

3.13.2 Transfer when a Non-Controlling Party has placed the Controlling Party on Hold

If a non-controlling party has placed the controlling party on Hold, when Transfer occurs the transferred call will be placed on hold. The holding party's PBX shall notify the other PBX by including HDG in the EEM containing CLI and CLC.

On receipt of an EEM containing HDG the PBX may apply holding indication locally. If the PBX cannot permit the call to be placed on hold it shall release the connection by sending a CRM with Clearing Cause: NT and expect a CIM in response.

3.13.3 Add-On when a Non-Controlling Party has placed the Controlling Party on Hold

If a non-controlling party is holding the call to the controlling party when an EEM containing AD-V is received, the PBX may reject the request. Alternatively it may accept the request and include HDG and ACK in the responding EEM.

If the Branching PBX allows the Add-On to go ahead, any party from which HDG was received shall be left disconnected from the conference. The Branching PBX may reject the Add-On request if both non-controlling parties are holding.

3.13.4 Clear after Add-On when a Remaining Party has placed the Conference on Hold

When a three party conference reverts to a two party call as a result of one party clearing, each of the remaining parties will receive an EEM containing TWP. If one of the remaining parties is holding the conference when it receives an EEM containing TWP it shall send an EEM containing HDG to the other PBX.

On receipt of an EEM containing HDG, the PBX may apply holding indication. If the PBX cannot permit the call to be placed on hold (eg because it too is holding the call), it shall clear the call by sending a CRM with Clearing Cause: NT and expect a CIM in response.

3.13.5 Split when a Non-Controlling Party has placed the Conference on Hold

When split occurs, each of the non-controlling party PBXs will receive an EEM containing TWP. If a non-controlling party is holding the conference when it receives an EEM containing TWP it shall send an EEM containing HDG to the Controlling PBX.

If the Controlling PBX receives an EEM containing HDG and COC it may apply holding indication to the controlling party. If the PBX cannot permit the controlling party to be placed on hold it shall clear the call by sending an SCRIM containing COC and Clearing Cause: NT and expect a SCIM in response.

If the Controlling PBX receives an EEM containing HDG it shall clear the held call by sending an SCRIM with Clearing Cause: NT and expect an SCIM in response.

3.14 ROUTE OPTIMISATION SERVICE - SWAP SERVICE

3.14.1 Route Optimisation Request clashes with Swap Request

If the Originating PBX receives an SM after sending an EEM containing ROP-R it shall abort the Route Optimisation attempt and handle the SM normally. If the Terminating PBX receives an EEM containing ROP-R after sending an SM it shall disregard the EEM containing ROP-R.

3.15 ROUTE OPTIMISATION SERVICE - EXECUTIVE INTRUSION

3.15.1 Route Optimisation Request clashes with IPL Request

If a PBX receives an EEM containing IPL-R after sending an EEM containing ROP-R it shall abort the Route Optimisation attempt and handle the EEM containing IPL normally. If a PBX receives an EEM containing ROP-R after sending an EEM containing IPL-R it shall disregard the EEM containing ROP-R.

3.15.2 Intrusion attempt during Route Optimisation

If an ISRM containing EI-R or EI-PVR is received and the wanted extension is busy on a call which is undergoing Route Optimisation, the intrusion request shall be saved until Route Optimisation is completed.

3.15.3 Intruding Call requires Route Optimisation

Route Optimisation shall not be carried out on a call which is intruding on another call or is undergoing or has undergone Prior Validation until such time as it becomes a Simple Call.

3.16 ROUTE OPTIMISATION SERVICE - HOLD SERVICE

3.16.1 Route Optimisation Request clashes with Hold Request

If a PBX receives an EEM containing HOLD-REQ after sending an EEM containing ROP-R it shall abort the Route Optimisation attempt and handle the EEM containing HOLD-REQ normally. If a PBX receives an EEM containing ROP-R after sending an EEM containing HOLD-REQ it shall disregard the EEM containing ROP-R.

3.17 ROUTE OPTIMISATION SERVICE - THREE PARTY SERVICE

3.17.1 Route Optimisation of a Call using a Shared Channel

A Controlling PBX shall not initiate Route Optimisation on behalf of either the Held or the Connected Call if they share a channel.

A Controlling PBX shall reject an EEM containing ROP-R from either the Held Call or the Connected Call if they share a channel.

3.17.2 Route Optimisation Request clashes with Shuttle Request

If a PBX receives an EEM containing ROP-R after sending an EEM containing SHTL it shall wait until the EEM containing ACK is received before rejecting the EEM containing ROP-R.

3.17.3 Route Optimisation Request clashes with Add-On Request

If a PBX receives an EEM containing ROP-R after sending an EEM containing AD-RQ it shall await a response to the Add-On Request before proceeding with Route Optimisation. If the Add-On Request is accepted (EEM containing AD-O received) the EEM containing ROP-R shall be disregarded. If the Add-On Request is rejected the EEM containing ROP-R shall be rejected.

If a PBX receives an EEM containing AD-O after sending an EEM containing ROP-R it shall abort Route Optimisation.

3.17.4 Route Optimisation during a Three Party Conference

A PBX involved in a three party conference shall not initiate Route Optimisation. A conference PBX shall reject an EEM containing ROP-R.

3.17.5 Route Optimisation Request clashes with Transfer

If a PBX receives an EEM containing TRFD after sending an EEM containing ROP-R it shall abort Route Optimisation.

If a PBX initiates Transfer involving a path on which it has returned a NAM in response to an ISRM containing ROP-CSU, but before receipt of the EEM containing ROP-CON, it shall either:

- delay the Transfer signalling until completion of the Route Optimisation Signalling, or
- clear the old path, connect the new path to held call and send the EEM containing TRFD on the new path. (ie the controlling PBX shall act as though ROP-CON had been received).

3.17.6 Route Optimisation Request clashes with Add-on Validation

The Controlling PBX of a 3-Party Situation using separate channels may, after sending EEMs containing AD-V along the two channels, receive an EEM containing ROP-R from one of them. The Route Optimisation Request shall be saved until the outcome of the Add-on attempt is known. If the Add-on is successful the Route Optimisation Request shall be disregarded. If the Add-on is unsuccessful the Route Optimisation Request shall be acted upon.

3.18 ROUTE OPTIMISATION - CALL OFFER

3.18.1 Route Optimisation required on an Offered Call

Route Optimisation shall not take place on an offered call until it becomes connected to the wanted party.

3.19 ROUTE OPTIMISATION - CALL WAITING

3.19.1 Route Optimisation required on a Waiting Call

Route Optimisation shall not take place on a waiting call until it becomes connected to the wanted party.

3.20 EXTENSION STATUS CALL - EXECUTIVE INTRUSION

3.20.1 Executive Intrusion Prior Validation Request on Extension Status Call

An ISRM containing EST may include String EI-PVR in order to determine the intrudibility status of the called extension. If the called extension is busy the Terminating PBX shall determine whether intrusion is possible by reference to IPLs of the wanted and unwanted parties and if so include String ACK in the returned CRM containing Clearing Cause: BY.

3.21 CONTROLLED DIVERSION - EXECUTIVE INTRUSION

3.21.1 Executive Intrusion Request with Controlled Diversion

String CDIV may be included in an ISRM containing EI-R or EI-PVR. If Diversion Immediate or On no Reply is encountered the rules of the Controlled Diversion Service apply.

If an ISRM containing EI-PVR and CDIV encounters Diversion on Busy and intrusion is possible, CDIV is ignored (a NAM containing DVT-B and ACK is returned). If intrusion is not possible the rules of the Controlled Diversion Service apply.

If the wanted extension is free or becomes free and has Diversion on No Reply registered, the rules of the Controlled Diversion Service apply.

3.22 CONTROLLED DIVERSION - THREE PARTY SERVICE

3.22.1 Controlled Diversion of an Enquiry Call

CDIV may be included in an ISRM containing ENQ or an RM containing SCE. If diversion is encountered the rules of the Controlled Diversion Service apply.

3.22.2 Transfer before Answer after Requesting Controlled Diversion

On receipt of String CDIV in an ISRM, a Terminating PBX will not run a timeout if Diversion on No Reply is registered. If an EEM containing TRFD is received before the extension answers the Terminating PBX shall start the timeout.

3.23 CONTROLLED DIVERSION - CALL OFFER SERVICE

3.23.1 Call Offer Request with Controlled Diversion

String CDIV may be included in an ISRM containing CO. If Diversion Immediate or on No Reply is encountered the rules of the Controlled Diversion Service apply. If Diversion on Busy is encountered the diversion shall be bypassed.

3.24 REDIRECTION SERVICE - DIVERSION SERVICE

3.24.1 Divert On No Reply while Redirecting

Timeout values should normally be configured so that any Diversion on No Reply takes place before Redirection, however:

If a PBX receives an EEM containing DVT-R or DVD-R from the original channel while establishing a redirected call using a different channel it shall clear the new call by sending a CRM with Clearing Cause: CT and handle the Diversion Request normally. A CIM shall be expected in response.

If a PBX receives an EEM containing DVT-R or DVD-R while establishing a redirected call using the same channel it shall save the EEM. If a NAM is subsequently received the EEM shall be discarded. If an RRM is received the EEM shall be acted upon.

3.24.2 Redirected Call Encounters Diversion Immediate or On Busy

If a redirected call encounters Diversion Immediate or On Busy, diversion shall occur. The signalling shall be as for a call Diverting Immediate or on Busy after Diverting on No Reply, except that String RDG shall be included in the ISRM or RM on the diverting call.

3.25 REDIRECTION SERVICE - THREE PARTY SERVICE

3.25.1 Redirection of an Enquiry Call

If the Controlling PBX of a three party situation needs to redirect the Enquiry (currently connected) Call the rules for Diversion of an Enquiry Call on No Reply (para 3.3.1.3) apply, except that String RDG is also included in the ISRM or RM containing ENQ and DVG-R, or the RM containing SCE and DVG-R.

3.25.2 Add-On while Establishing Redirected Call

If an EEM containing AD-V is received while establishing a redirected call (eg after Timeout on hold) on a different channel it shall be acted upon in the normal way. If an EEM containing AD-O is received while establishing a redirected call on a different channel the redirected call shall be cleared and the EEM containing AD-O acted upon.

If an EEM containing AD-O or AD-V is received while establishing a redirected call on the same channel it shall be saved; if an RRM is subsequently received the EEM shall then be acted upon.

3.26 THREE PARTY TAKEOVER SERVICE - ROUTE OPTIMISATION SERVICE

3.26.1 Route Optimisation Request clashes with Three Party Takeover Request

If a PBX receives an EEM containing TOV-R after sending an EEM containing ROP-R it shall abort the Route Optimisation attempt and handle the EEM containing TOV-R normally. If a PBX receives an EEM containing ROP-R after sending an EEM containing TOV-R it shall disregard the EEM containing ROP-R.

3.27 SERIES CALL - EXECUTIVE INTRUSION SERVICE

3.27.1 Series Call Request or Series Call Cancel clashes with IPL Request

An EEM containing IPL-R may cross with an EEM containing SER-R or SER-C. Each EEM shall be acted upon normally.

3.28 SERIES CALL - HOLD SERVICE

3.28.1 Series Call Request or Series Call Cancel clashes with Hold Request

An EEM containing HOLD-REQ may cross with an EEM containing SER-R or SER-C. Each EEM shall be acted upon normally.

3.29 SERIES CALL - ROUTE OPTIMISATION

3.29.1 Series Call Request clashes with Route Optimisation Request

If a PBX receives an EEM containing SER-R after sending an EEM containing ROP-R it shall abort the Route Optimisation attempt and handle the EEM containing SER-R normally. If a PBX receives an EEM containing ROP-R after sending an EEM containing SER-R it shall disregard the EEM containing ROP-R.

3.30 NIGHT SERVICE - DIVERSION SERVICE

3.30.1 Diverted Call Encounters Operator in Night Mode

If a diverted call encounters an operator in Night Mode it shall undergo Night Service Diversion if available.

3.30.2 Night Service Diverted Call Encounters Diversion Immediate or On Busy

A Night Service Diverted Call may be further diverted either Immediate or on Busy. The signalling is as for Diversion Immediate or on Busy following Diversion on No Reply, except that the new diverted call will have String NS-DVG in the ISRM or RM.

3.30.3 Night Service Diverted Call Encounters Diversion On No Reply

A Night Service Diverted call may be further Diverted on No Reply. The signalling is as for Diversion on No Reply except that the new diverted call will have String NS-DVG in the ISRM or RM.

3.30.4 Diversion By-Pass Call Encounters Operator in Night Mode

The presence of String DIV-BY in the ISRM shall not prevent the return of String NS-DVT if Night Mode is encountered. It is up to the Originating PBX to decide what action to take.

3.31 NIGHT SERVICE - THREE PARTY SERVICE

3.31.1 Enquiry Call Encounters Operator in Night Mode

An Enquiry Call encountering an operator in Night Mode shall undergo Night Service Diversion if available. The establishment of the diverted Enquiry Call shall be as for diversion of an Enquiry call on No Reply (paragraph 3.3.1.3) except for the inclusion of String NS-DVG. If Rediversion subsequently takes place the establishment of the Rediverted Enquiry Call shall be similar except that String NS-RDVG shall replace String NS-DVG.

3.32 NIGHT SERVICE - EXTENSION STATUS CALL

3.32.1 Extension Status Call Encounters Operator in Night Mode

If an Extension Status call encounters an operator in Night Mode the CRM shall have a Clearing Cause: ACK and shall contain String NS-DVT.

3.33 NIGHT SERVICE - CONTROLLED DIVERSION

3.33.1 Controlled Diversion Call Encounters Operator in Night Mode

The presence of String CDIV in an ISRM has no effect on Night Service Diversion.

3.34 NIGHT SERVICE - REDIRECTION SERVICE

3.34.1 Redirected Call Encounters Operator In Night Mode

If a Redirected call undergoes Night Service Diversion, String RDG shall be included in the ISRM or RM on the diverted call. If the call subsequently undergoes Night Service Rediversion, String RDG shall again be included in the rediverted ISRM or RM. If a call being redirected due to Call Failure undergoes Night Service Diversion or Rediversion, an RCF String shall be included in the ISRM or RM.

3.35 NIGHT SERVICE - SERIES CALL

3.35.1 Series Call Encounters Operator in Night Mode

If Series Call establishment encounters an operator in Night Mode, normal Night Service procedures shall apply, except that String SER-E shall be included in any diverted or rediverted ISRM or RM.

3.36 SWAP - HOLD

A held party is not permitted to request a change of service. If a SW-V request is received from a held party the Controlling PBX shall refuse the request by sending a SWAP Message containing the String Swap Rejection (SW-R) indicating that the services are incompatible (Parameter = I).

3.37 SWAP - THREE PARTY

3.37.1 Swap Request during an Enquiry Call

If, while in the enquiry mode of a 3 party call, the controlling or connected party requests a change of service this shall be carried out. The String COC shall be added to all messages used between the Controlling PBX and the Branching PBX.

If, while in the enquiry mode of a 3 party call, the held party requests a change of service the Controlling PBX shall refuse the swap by sending a Swap Message containing the String Swap Rejection (SW-R) indicating that the services are incompatible (Parameter = I).

If, after changing service, the controlling party is to be reconnected to a party with a different service in force (because of a party having released) the connection shall not be made.

In each of these cases it is the responsibility of the Controlling PBX to retain knowledge of the service in force for each party and to carry out all compatibility checks.

3.37.2 Shuttle after Swap

If, after changing service, the controlling party attempts to shuttle to a party with a different service active, the shuttle request shall be refused. Shuttle may only be carried out when the service has been returned to that in force when last connected to the Held party.

If a Swap Request crosses over with a Shuttle Request (SHTL) the controlling PBX shall refuse the Swap by sending a Swap message containing the String Swap Rejection (SW-R) indicating that the services are incompatible (Parameter = I).

3.37.3 Transfer after Swap

If, after changing service, the controlling party attempts to carry out a transfer when different services are active at the other two parties, the transfer request shall be refused. Transfer may only be carried out when the service has been returned to that in force when last connected to the held party.

If a Swap Request crosses over with a Transfer Request (TRFD) on receipt of the EEM containing the String TRFD, the connected PBX shall abandon the Swap and carry out the Transfer.

3.37.4 Swap after Add-on

If, while in a three party conference, the controlling party requests a change of service the request shall not be carried out. The Controlling PBX shall not send the Swap message in these circumstances.

If either of the non-controlling parties requests a change of service the Conference PBX shall refuse the Swap by sending a Swap message containing the String Swap Rejection (SW-R) indicating that the services are incompatible (Parameter = I).

If a Swap Request crosses over with an Add-On Request (either AD-RQ or AD-V) the Controlling PBX shall refuse the Swap by sending a Swap message containing the String Swap Rejection (SW-R) indicating that the services are incompatible (Parameter = I). On receipt of an EEM containing AD-O a non-controlling PBX shall abandon the Swap and carry out the Add-On.

3.38 SWAP - EXECUTIVE INTRUSION

On receipt of an Intrusion Protection Level Request (IPL-R) while awaiting the response to a Swap Request, the returned IPL shall be the one applicable for the call before the Swap.

A Swap shall not be initiated while awaiting the response to the Intrusion Protection Level Request (IPL-R) or while Intrusion is in progress.

On receipt of an SM while awaiting the response to the Intrusion Protection Level Request (IPL-R) the Controlling PBX shall refuse the Swap by sending a Swap message containing the String Swap Rejection (SW-R) indicating that the services are incompatible (Parameter = I).

3.39 CALL BACK WHEN FREE - CALL WAITING

If a Call Back When Free Call Set-Up or an EEM containing RO is received by an extension which is busy and has Call Waiting active the Call Waiting shall be ignored.

3.40 CALL OFFER - REDIRECTION

If a call using Call Offer is subject to Redirection the Call Offer String shall not be included in the ISRM for the new call. Call Offer may be applied if the called party is busy as for a Simple Call.

3.41 CALL WAITING - REDIRECTION

If a Redirected call encounters an extension which is busy and has Call Waiting active, Call Waiting shall be applied.

3.42 TRAFFIC CHANNEL MAINTENANCE - SIMPLE TELEPHONY CALL

If an ISRM is received while back busying a traffic channel, the call shall be rejected in the same way as for a call received after the channel is back busied. Back busy shall be applied.

If, after sending an ISRM, an LMM is received, requesting that the channel be busied out, the back busy state shall be changed independently of the call.

If, while awaiting a response to an ISRM a request to loop back the traffic channel is received, the loop back request shall be ignored.

If an ISRM is received while attempting to loop back a traffic channel the loop back attempt shall be abandoned and the ISRM processed.

3.43 HOLD - SUPPLEMENTARY FACILITIES INHIBITED

If an established call has Supplementary Facilities Inhibited (SFI) stored, then a request to hold will be rejected.

If the established call does not have an SFI stored and an Enquiry Call is made which does, then requests to Shuttle or Add-On will be ignored. If the controlling party attempts to transfer the call, then the connected party is released. The held call will now call the controlling party.

3.44 SUPPLEMENTARY FACILITIES INHIBITED - THREE PARTY SERVICE

If an Enquiry Call, which has SFI associated, is made (with the other two parties of the Three Party Conference on hold) then an attempt to Add On or Shuttle shall be ignored. An attempt to transfer shall result in the Enquiry Call being cleared, the two parties on hold will remain on hold and the clearing party will be recalled. When the cleared party answers, a 3-party conference will again be established.

3.45 SUPPLEMENTARY FACILITIES INHIBITED - DIVERSION

When a protected call containing the String SFI, is presented to an extension which has diversion invoked, then the diversion shall be bypassed. If the extension is busy the caller may request Priority Breakdown. A check will be made to see if the request is allowed.

3.46 SUPPLEMENTARY FACILITIES INHIBITED - CALL BACK WHEN FREE

A Call Back When Free request will be rejected when made to an extension which has SFI as a service marking.

3.47 SUPPLEMENTARY FACILITIES INHIBITED - CALL WAITING

When a PBX receives an ISRM containing the SFI String, for an extension which is busy but has Call Waiting registered, it shall return a CRM containing the Clearing Cause: BY. A CIM shall be expected in response.

3.48 SUPPLEMENTARY FACILITIES INHIBITED - CALL OFFER

When an ISRM containing the String CO is presented to an engaged extension which has SFI registered, a CRM containing the Clearing Cause: BY shall be returned to the Calling PBX. A CIM shall be expected in response.

3.49 SUPPLEMENTARY FACILITIES INHIBITED - EXECUTIVE INTRUSION

When an ISRM with String EI-R is presented to an extension which is engaged in a call that has SFI associated then a CRM with Clearing Cause: BY shall be returned towards the Originating PBX. A CIM shall be expected in response.

3.50 SUPPLEMENTARY FACILITIES INHIBITED - SWAP

A request to Swap presented to a call with SFI stored will be rejected.

3.51 SUPPLEMENTARY FACILITIES INHIBITED - REDIRECTION

When a PBX receives an ISRM containing String RDG but without String SFI and when the indicated extension is busy, then the call will proceed as for normal Redirection. Redirection will be prevented for calls arriving when the ISRM also contains String SFI.

3.52 PRIORITY BREAKDOWN - SWAP

There are no restrictions for the Swap Service. In addition the String PB-P with Parameter BPL and optionally String SFI may be included in the Swap Message in order that the protection level may be uprated for the data call.

3.53 PRIORITY BREAKDOWN - HOLD

A protected call may be placed on hold. A request to breakdown a Held Call will be allowed to proceed.

3.54 PRIORITY BREAKDOWN - ROUTE OPTIMISATION

The request to optimise a protected call will be allowed to proceed.

3.55 PRIORITY BREAKDOWN - CALL WAITING

When a PBX received an ISRM with String PB-R for an extension which has Call Waiting registered it shall prevent Call Waiting proceeding and carry out the Priority Breakdown.

3.56 PRIORITY BREAKDOWN - THREE PARTY SERVICE (TRANSFER)

When transfer is being effected, the Branching PBX shall send an EEM to both remaining parties. Each PBX shall then send an EEM containing CLC and CLI to the other. If either of the calls has a protection level associated, the String PB-P together with Parameter BPL shall be included in the EEM. On receipt of the EEM the BPL (if present) shall be compared with the BPL stored at that PBX. If the Parameter stored is the same as that received or less, then no further action shall be taken. If the stored Parameter is greater than that received, then that PBX shall send an LLM containing String PB-P with Parameter BPL. This will cause all associated PBXs to have their protection levels updated.

3.57 CALL BACK WHEN FREE - CALL BACK WHEN NEXT USED

A PBX may allow a calling extension to have CBWF and CBWNU requests registered at the same time, provided they are all to different called extensions. A PBX may allow a called extension to have CBWF and CBWNU requests registered at the same time, provided they are all from different calling extensions.

3.58 DIVERSION - CALL BACK WHEN NEXT USED - CBWNU REQUEST ON DIVERTED CALLS

Divert [Immediate] - As for CBWF - see page 7, paragraph 3.1.1.1 .

Divert [On Busy] - If a call that has followed Divert On Busy receives no reply and the caller requests CBWNU, the Originating PBX shall treat it as a CBWF request on the busy extension.

Divert [On No Reply] - If a call that has followed Divert On No Reply still receives no reply and the caller requests CBWNU, the CBWNU request shall be registered against the original called extension.

3.59 THREE PARTY SERVICE - CALL BACK WHEN NEXT USED

If an enquiry Call fails to receive a reply the caller may request CBWNU. The CBWNU request is made by means of a Virtual Call in the normal way. No additional Strings are included in the ISRM to indicate that the calling party is making an Enquiry Call.

3.60 CALL DISTRIBUTION - DIVERSION

3.60.1 Investigative Call Encounters Diversion

If DVT-I or DVT-B (accompanied by Clearing Cause: BY) is received in response to an Investigative Call, the Distributor PBX may take one of two actions:

- (i) the Answer Point may be classed as unavailable for Distribution (ie no calls will be Forwarded to it) or
- (ii) the Distributor may make an Investigative Call to the address defined by the DVT-I/B String (if it has not already done so because the address is that of an existing Answer Point).

DVT-R or DVT-B (not accompanied by Clearing Cause: BY) shall be ignored.

3.60.2 Forwarding Call Encounters Diversion

If DVT-I or DVT-B is received in the NAM of a Forwarding Call one of two actions can be taken:

- (i) the Answer Point can be classed as unavailable. The channel shall be cleared forward using a CRM with Clearing Cause: CT. The Distributor shall then repeat the Investigation (if the Forwarding call contained a CD-Q String) or shall immediately Forward the call to another Answer Point (if the Forwarding call contained a CD-DNQ String) or
- (ii) the channel shall be cleared forward using a CRM with Clearing Cause: CT. The call shall then be Forwarded to the address defined by the DVT-I/B String with a DVG-I/B String added to the ISRM.

DVT-R cannot be received at the Distributor PBX because it is sent in an EEM following a NAM and once the Distributor PBX has processed a NAM it becomes an ordinary Transit PBX.

3.60.3 Linked Into Queue Indication Encounters Diversion

If a Linked Into Queue indication is received by an Answer Point that has Diversion-Immediate registered a CRM with a CC:REJ is returned with a DVT-I String. The Distributor can then take one of the following actions:

- (i) merely register the fact that no Free Notification will be received from this Answer Point and wait for one of the other Answer Points or
- (ii) send a Linked Into Queue indication to the address defined by the DVT-I String.

The fact that an Answer Point has Diversion - On Busy or Diversion - On No Reply active does not affect the processing of a Linked Into Queue indication.

3.60.4 Call Set Up Encounters Diversion

If DVT-I or DVT-B is received in the NAM of a Call Set-Up one of two actions can be taken:

- (i) the Answer Point can be classed as unavailable; the channel shall be cleared forward using a CRM with CC:CT and the Distributor shall wait for a Free Notification from another Answer Point or
- (ii) the channel shall be cleared forward using a CRM with CC:CT; the Call Set-Up shall then be repeated to the address defined by the DVT-I/B String with a DVG-I/B String added to the ISRM.

DVT-R cannot be received at the Distributor because it is sent in an EEM following a NAM and, once the NAM has been processed, the Distributor becomes an ordinary Transit PBX.

3.60.5 Call Diverted to Distributor

A call may be Diverted to a Distributor, either as a result of an on-PBX or an of-PBX Diversion. In both cases a DVG-I/B/R String is added to the ISRM in Call Distribution - Forwarding or Call Distribution - Call Set Up as appropriate.

3.61 CALL DISTRIBUTION - NIGHT SERVICE DIVERSION

3.61.1 Investigative Call Encounters Night Service Diversion

If NS-DVT is received in response to an Investigative Call Distributor may take one of two actions:

- (i) the Answer Point may be classed as unavailable for Distribution (ie no calls will be Forwarded to it) or
- (ii) the Distributor may make an Investigative Call to the address defined by the NS-DVT String (if it has not already done so because the address is that of an existing Answer Point).

3.61.2 Forwarding Call Encounters Night Service Diversion

If NS-DVT is received in response to a Forwarded call the Distributor may take one of two actions:

- (i) the Answer Point can be classed as unavailable; the channel shall be cleared forward using a CRM with CC:CT; the Distributor shall then repeat the Investigation (if the Forwarding call contained a CD-Q String) or shall immediately Forward the call to another Answer Point (if the Forwarding call contained a CD-DNQ String) or
- (ii) the channel shall be cleared forward using a CRM with CC:CT; the call shall then be Forwarded to the address defined by the NS-DVT String.

3.61.3 Linked Into Queue Indication Encounters Night Service Diversion

If a Linked Into Queue indication is received by an Answer Point that has Night Service Diversion registered a CRM with CC:SOS is returned with a NS-DVT String. The Distributor can then take one of the following actions:

- (i) merely register the fact that no Free Notification will be received from this Answer Point and wait for one of the other Answer Points or

- (ii) send a Linked Into Queue indication to the address defined by the NS-DVT String.

3.61.4 Call Set Up Encounters Night Service Diversion

If a NS-DVT String is received in response to a Call Set Up one of two actions be taken:

- (i) the Answer Point can be classed as unavailable; the channel shall be cleared forward using a CRM with CC:CT and the Distributor shall wait for a Free Notification from another Answer Point or
- (ii) the channel shall be cleared forward using a CRM with CC:CT; the Call Set Up shall then be repeated to the address defined by the NS-DVT String.

3.61.5 Call Night Service Diverted to Distributor

A call may be Night Service Diverted to a Distributor, either as a result of an on-PBX or off-PBX Night Service Diversion. In both cases a NS-DVG String shall be added to the ISRM in Call Distribution - Forwarding or Call Distribution - Call Set-Up, as appropriate.

3.62 CALL DISTRIBUTION - ROUTE OPTIMISATION

An originating PBX may initiate Route Optimisation following Call Distribution. The Distributed Group Parameter of the CLC returned to the Originating PBX indicates that Call Distribution is taking place.

3.63 CALL DISTRIBUTION - CALL BACK WHEN FREE

A Distributor PBX may clear an incoming call with CC:BY because it is temporarily unable to carry out distribution processing. The originating party may then request Call Back When Free. The signalling either follows the same sequence as any other Call Back with the Call Back - Free Notification being sent when the Distributor becomes able to process distribution again, or the Distributor may reject the Call Back When Free - Request using a CRM with CC:SU.

3.64 CALL DISTRIBUTIION - CALL BACK WHEN NEXT USED

If a Call Back When Next Used - Request is received at a Distributor PBX it is rejected using a CRM with CC:SU.

If an Originating PBX receives a Distributed Group Parameter to a CLC in a NAM it may bar a Call Back When Next Used request locally in order to avoid the call to the Distributor PBX from being cleared.

3.65 CALL DISTRIBUTION - EXECUTIVE INTRUSION

It is possible that a Distributor PBX may receive an Intrusion request as a result of being found busy. Thus on receipt of an ISRM containing EI-R or EI-PVR or an EEM containing EI-R the request shall be rejected with a CRM containing CC:BY. A CIM shall be expected in response.

3.66 CALL DISTRIBUTION - THREE PARTY

3.66.1 Enquiry Call Encounters Call Distribution

If an ENQ String is received in an ISRM at a Distributor PBX the String should be repeated in the ISRM of a Forwarding call or Call Set-Up.

3.66.2 Transfer During Call Distribution

If a TRFD String is received in an EEM at a Distributor PBX whilst it is in the process of distributing the call (ie before the Distributor becomes a Transit PBX as a result of the successful Forwarding or Call Set Up) the EEM sent in response shall contain the CLC and CLI of the Distributor. The OLI and CLC in the Forwarding or Call Set Up call shall be that of the new connected party.

A Call Transfer may take place while Forwarding or Call Set Up are in progress (ie when waiting for a NAM after sending an ISRM with CD-Q/DNQ). If this occurs, then in order that the Answer Point and the new connected party may be aware of each other's identity the Distributor shall send an EEM with TRFD to each of them once the NAM has been received. This will cause them to swap CLC and OLI/CLI.

3.67 CALL DISTRIBUTION - CALL OFFER

The signalling for a Call Offer request on a Distributor PBX follows the same sequence as any other Call Offer, with availability of the Distributor simulating a wanted party accepting by clearing.

3.68 CALL DISTRIBUTION - LOOP AVOIDANCE

A distributor shall behave as an End with regard to any LA String in an incoming ISRM. It may also automatically insert an LA String when Forwarding calls and for Call Set Up.

3.69 CALL PARK - DIVERSION

If a PARK request is received for an extension that has any form of Diversion registered, the Diversion shall be bypassed and the PARK request shall continue as if no Diversion was registered.

3.70 WAIT ON BUSY - DIVERSION

3.70.1 Wait On Busy Request on a Diverted Call

3.70.1.1 Divert Immediate

If a call that has been Diverted Immediate finds the nominated extension is engaged, the caller may request Wait On Busy.

Under these circumstances the Originating PBX should make a new call to the nominated extension and include WOB and DVG-I in the ISRM.

3.70.1.2 Divert On Busy

If a call that has been Diverted on Busy finds the nominated extension is also engaged the caller may request Wait On Busy.

Under these circumstances the Originating PBX shall make a new call to the original extension and include WOB in the ISRM.

3.70.1.3 Divert on No Reply

As a call which has been diverted on no reply cannot be presented to a busy extension, Wait On Busy will not be requested by the caller.

Also a Wait On Busy call that has been Diverted on No Reply will not have WOB present in the ISRM or RM (see paragraph 3.70.2.3).

3.70.2 Wait On Busy Request encounters Diversion

3.70.2.1 Divert Immediate

If a Wait On Busy Request is received by an extension that has Divert Immediate registered to an extension on another PBX, it shall ignore the request and return DVT-I in the NAM in the normal way. The Originating PBX shall make the diversion call to the new extension and include both DVG-I and WOB in the ISRM or RM.

If the Divert Immediate is to an extension within the Terminating PBX, the Wait On Busy Request shall act upon the nominated extension and DVD-I shall be added to the returned NAM or CRM.

If a Wait On Busy Request containing DIV-BY is received by an extension that has Divert Immediate registered, the diversion shall be bypassed.

3.70.2.2 Divert on Busy

If a Wait On Busy Request is received by an extension that has Divert on Busy registered the diversion shall be by-passed.

3.70.2.3 Divert on No Reply

If a Wait On Busy Request is received by an extension that has Divert on No-Reply registered, the action taken will depend on whether the extension is busy or free:

- if the extension is free, normal Divert on No-Reply action shall be taken. On receipt of the EEM containing DVT-R the Originating PBX shall not include WOB in the ISRM or RM of the diverting call.
- if the extension is busy, the Wait On Busy Request shall be handled as if the diversion was not registered.

3.71 THREE PARTY SERVICE - WAIT ON BUSY

3.71.1 Enquiry Call Requests Wait On Busy

If an Enquiry Call encounters a busy extension the caller may request Wait On Busy. Under these circumstances the Originating PBX shall remake the Enquiry Call and include WOB in the ISRM ENQ or RM SCE. The request shall be handled by the Terminating PBX as a normal Wait On Busy request, except that a special calling signal may be applied.

3.71.2 Transfer During Wait On Busy

After Wait On Busy has been invoked on an Enquiry Call the Controlling Party may transfer. On receipt of an EEM containing TRFD the Enquired to PBX shall include the Strings Call Waiting (CW) and Wait On Busy (WOB) (in addition to CLI and CLC-ORD) in the EEM sent to the PBX to which it is now connected.

3.72 CALL WAITING - WAIT ON BUSY

3.72.1 Wait On Busy Request Encounters Call Waiting

If a Wait On Busy Request encounters an extension with Call Waiting registered, the Wait On Busy Request shall be ignored and normal Call Waiting action shall be taken.

3.73 ROUTE OPTIMISATION - WAIT ON BUSY

3.73.1 Route Optimisation Required On A Wait On Busy Call

Route Optimisation shall not take place on a Wait On Busy call until it becomes connected to the wanted party.

3.74 CONTROLLED DIVERSION - WAIT ON BUSY SERVICE

3.74.1 Wait On Busy Request With Controlled Diversion

String CDIV may be included in an ISRM containing WOB. If Diversion Immediate or on No Reply is encountered the rules of the Controlled Diversion Service apply. If Diversion on Busy is encountered the diversion shall be by-passed.

3.75 WAIT ON BUSY - REDIRECTION

If a call using Wait On Busy is subject to Redirection the WOB String shall not be included in the ISRM for the new call.

3.76 SUPPLEMENTARY FACILITIES INHIBITED - WAIT ON BUSY

When an ISRM containing the String WOB is presented to an engaged extension which has SFI registered, a CRM containing the Clearing Cause: BY shall be returned to the Calling PBX.

3.77 CALL DISTRIBUTION - WAIT ON BUSY

The signalling for a Wait On Busy request on a Distributor PBX follows the same sequence as any other Wait On Busy, with availability of the Distributor simulating a wanted party accepting by clearing.

3.78 CALL PICK-UP SERVICE - DIVERSION

3.78.1 Pick-up of an Incoming Diverted Call

The presence of DVG-I, DVG-B or DVG-R in the ISRM of the call awaiting answer shall have no effect on the Target PBX's handling of a Call Pick-up Request.

If the Originating PBX of a Diverting call receives an EEM containing PU-DVT it shall be acted upon as described in SECTION 46 of this specification except that the Parameter of the DVG-R String in the resultant Pick-up Call shall be the address of the original destination instead of the extension from which the call has been picked-up. In the case of Divert Immediate or Busy the DVG-I or DVG-B Strings shall not be included in the Pick-up Call.

3.78.2 Diversion on No-Reply Encounters Call Pick-Up

The running of a Divert on No-Reply timeout shall not prevent a Target PBX from sending an EEM containing PU-DVT. If, however, the timeout expires before a response to PU-DVT is received, then the sending of an EEM containing DVT-R shall be delayed until a response is received. An EEM containing DVT-R shall only be sent if the Pick-Up attempt does not succeed, ie if an EEM containing REJ is received.

3.78.3 Call Pick-Up encounters Diversion on No-Reply

If a Pick-Up request is received by a Target PBX after it has sent an EEM containing DVT-R, the request shall be handled in the normal manner, ie an EEM containing PU-DVT shall be sent. If an Originating PBX that has acted upon receipt of an EEM containing DVT-R, is still awaiting a NAM or CRM on the new call when it receives an EEM containing PU-DVT on the original call, then the processing of PU-DVT shall be delayed. If a CRM is received on the new call, PU-DVT shall be handled in the normal manner. If a NAM is received on the new call, so that the original call is cleared, then PU-DVT shall be discarded.

3.79 CALL PICK-UP SERVICE - THREE PARTY SERVICE

3.79.1 Pick-up of an Incoming Enquiry Call

The presence of ENQ in the ISRM of the call awaiting answer shall have no effect on the Target PBX's handling of a Call Pick-Up Request.

If the Originating PBX of an Enquiry call receives an EEM containing PU-DVT it shall be acted upon as described in SECTION 46 of this specification except that an ENQ String shall be included in the ISRM of the resultant Pick-Up Call.

3.80 CALL PICK-UP SERVICE - NIGHT SERVICE

3.80.1 Pick-up of an Incoming Night Service Diverted Call

The presence of DVG-R and NS-DVG in the ISRM of the call awaiting answer shall have no effect on the Target PBX's handling of a Call Pick-Up Request.

If the Originating PBX of a Night Service Diverting call receives an EEM containing PU-DVT it shall be acted upon as described in SECTION 46 of this specification except that the Parameter of the DVG-R String in the ISRM of the resultant Pick-Up Call shall be the address of the original destination instead of that of the extension from which the call has been picked-up. An NS-DVG String shall be included in the ISRM of the Pick-Up Call.

3.80.2 Night Service Rediversion Encounters Call Pick-Up

A Target PBX shall not send an EEM containing NS-RDVT whilst the response to PU-DVT is still awaited. Night Service Re-diversion may only be invoked if the Pick-Up is unsuccessful, ie if an EEM containing REJ is received.

3.80.3 Call Pick-Up Encounters Night Service Rediversion

If a Pick-Up request is received by a Target PBX after it has sent an EEM containing NS-RDVT, the request shall be handled in the normal manner, ie an EEM containing PU-DVT shall be sent. If an Originating PBX that has acted upon receipt of an EEM containing NS-RDVT, is still awaiting a NAM or CRM on the new call when it receives an EEM containing PU-DVT on the Night Service call, then the processing of PU-DVT shall be delayed. If a CRM is received on the new call, PU-DVT shall be handled in the normal manner. If a NAM is received on the new call, so that the Night Service call is cleared, then PU-DVT shall be discarded.

3.81 CALL PICK-UP SERVICE - REDIRECTION

3.81.1 Pick-up of an Incoming Redirected Call

The presence of DVG-R and RDG in the ISRM of the call awaiting answer shall have no effect on the Target PBX's handling of a Call Pick-Up Request.

If the Originating PBX of a Redirected call receives an EEM containing PU-DVT it shall be acted upon as described in SECTION 46 of this specification except that the Parameter of the DVG-R String in the ISRM of the resultant Pick-Up Call shall be the address of the original destination instead of that of the extension from which the call has been picked-up. An RDG String shall be included in the ISRM of the Pick-Up Call.

3.81.2 Redirection by the Originating PBX Encounters Call Pick-Up

An Originating PBX shall not initiate Redirection whilst the response to PU-DVG is still awaited. Redirection may only be invoked if the Pick-Up is unsuccessful, ie if a CRM is received.

3.81.3 Call Pick-Up Encounters Redirection by the Originating PBX

If an Originating PBX that has initiated Redirection is still awaiting a NAM or CRM on the new call when it receives an EEM containing PU-DVT on the original call, then the processing of PU-DVT shall be delayed. If a CRM is received on the new call, PU-DVT shall be handled in the normal manner. If a NAM is received on the new call, so that the original call is cleared, then PU-DVT shall be discarded.

3.81.4 Redirection by the Terminating PBX Encounters Call Pick-Up

A Target PBX shall not send an EEM containing DVT-RD whilst the response to PU-DVT is still awaited. Redirection may only be invoked if Pick-Up is unsuccessful, ie if an EEM containing REJ is received.

3.81.5 Call Pick-Up Encounters Redirection by the Terminating PBX

If a Pick-Up request is received at a Target PBX after it has sent an EEM containing DVT-RD, the request shall be handled in the normal manner, ie an EEM containing PU-DVT shall be sent. If an Originating PBX that has acted upon receipt of an EEM containing DVT-RD, is still awaiting a NAM or CRM on the new call when it receives an EEM containing PU-DVT on the original call, then the processing of PU-DVT shall be delayed. If a CRM is received on the new call, PU-DVT shall be handled in the normal manner. If a NAM is received on the new call, so that the original call is cleared, then PU-DVT shall be discarded.

3.82 CALL PICK-UP SERVICE - CALL BACK WHEN FREE

3.82.1 Pick-up of Call Back Call at Requesting Extension

A Call Pick-Up Request may be made to an extension which has previously requested Call Back When Free and is ringing due to a notification that the wanted party is now free. Under these circumstances the Pick-Up request shall be rejected by the Target PBX by clearing the Virtual Call with a CRM containing Clearing Cause: Service Temporarily Unavailable. A CIM shall be expected in response.

3.82.2 Pick-up of a Call Back Call at the Wanted Extension

A Pick-Up Request may be made to an extension that is ringing due to an incoming Call Back Call. Under these circumstances the Pick-Up request shall be handled by the Target PBX in the normal way. The Originating PBX of a Call Back Call, on receipt of an EEM containing PU-DVT shall act as described in SECTION 46.

3.83 CALL PICK-UP SERVICE - CALL BACK WHEN NEXT USED

3.83.1 Pick-up of a Call Back Call at the Requesting Extension

A Call Pick-Up Request may be made to an extension which has previously requested Call Back When Next Used and is ringing due to a notification that the wanted party is now free after being used. Under these circumstances the Pick-Up request shall be rejected by the Target PBX by clearing the Virtual Call with a CRM containing Clearing Cause: Service Temporarily Unavailable. A CIM shall be sent in response.

3.83.2 Pick-up of a Call Back Call at the Wanted Extension

A Pick-Up Request may be made to an extension that is ringing due to an incoming Call Back Call. Under these circumstances the Pick-Up request shall be handled by the Target PBX in the normal way. The Originating PBX of a Call Back Call, on receipt of an EEM containing PU-DVT shall act as described in SECTION 46.

3.84 DO NOT DISTURB - EXECUTIVE INTRUSION

3.84.1 Executive Intrusion Request Encounters Do Not Disturb

If an Executive Intrusion Request (without Prior Validation) containing Do Not Disturb-Override is received for an extension that has Do Not Disturb registered, the Executive Intrusion Request shall be processed as if Do Not Disturb was not registered.

3.85 DO NOT DISTURB - CALL OFFER

3.85.1 Call Offer Request Encounters Do Not Disturb

If a Call Offer Request containing Do Not Disturb Override is received for an extension that has Do Not Disturb registered, the Call Offer Request shall be processed as if Do Not Disturb was not registered.

3.86 DO NOT DISTURB - WAIT ON BUSY

3.86.1 Wait On Busy Request Encounters Do Not Disturb

If a Wait On Busy Request containing Do Not Disturb Override is received for an extension that has Do Not Disturb registered, the Wait On Busy Request shall be processed as if Do Not Disturb was not registered.

3.87 DO NOT DISTURB - REDIRECTION

3.87.1 Call failure Caused by a Do Not Disturb Registration

If a call fails because an extension with the DND condition invoked is encountered, and as a result the Originating PBX initiates Redirection on Call Failure to an alternative destination, the String DND may be included in the ISRM containing RCF.

DIGITAL PRIVATE NETWORK SIGNALLING SYSTEM NO 1 (DPNSS 1)

SECTION 6 - SIMPLE TELEPHONY CALL

CONTENTS

1	GENERAL	Page 2
2	SIMPLE TELEPHONY CALL WITHIN DPNSS 1	Page 3
2.1	DEFINITION	Page 3
2.2	DESCRIPTION	Page 3
2.3	OUTLINE OF OPERATION	Page 4
2.3.1	Call Set Up.....	Page 5
2.3.2	Call Clear Down.....	Page 10
3	SDL DIAGRAMS	Page 12
4	COMPLIANCE	Page 16

HISTORY

Issue 1 - May 1983.
Issue 2 - February 1984
Issue 3 - September 1984
Issue 4 - March 1986
Issue 5 - December 1989
Issue 5.1 - December 1993
Issue 6 - January 1995

Issue 7 - March 2001 - Specification renamed as DPNSS[188]
- SDL Diagrams added

REFERENCES

DPNSS[189], DPNSS[189-I]

1 GENERAL

- 1.1** This Section details the signalling requirements of DPNSS 1 for Simple Telephony Calls.
- 1.2** Subsection 2 details a Simple Call within DPNSS 1.
- 1.3** Subsection 3 details a Simple Call within DPNSS 1 in SDL format.
- 1.4** Subsection 4 shows the Compliance.
- 1.5** DPNSS[189] details Simple Calls when DPNSS 1 interworks with other signalling systems.
- 1.6** The description is given in the form of Message Sequence Diagrams (MSDs) followed by explanatory text.
- 1.7** The text is referenced from MSDs at appropriate points in the sequences.
- 1.8** Message contents for successful calls are shown in MSDs. Messages and their contents for alternative sequences (eg for unsuccessful calls) are detailed in the text.
- 1.9** Coding of the contents of messages is given in SECTION 4.

2 SIMPLE TELEPHONY CALL WITHIN DPNSS 1

2.1 DEFINITION

The Simple Telephony Call provides the facilities for establishing a Telephony connection between any two DPNSS 1 Network extensions without the need for operator assistance. A Simple Call does not involve any Supplementary Service requests.

2.2 DESCRIPTION

This Section only deals with a Simple Call which originates and terminates at user extensions within a DPNSS 1 network.

Procedures for calls that originate or terminate outside a DPNSS 1 network are detailed in DPNSS[189] and DPNSS[189-I].

NOTES ON TRAFFIC CHANNELS:

SECTION 2 describes the physical characteristics of a number of standardised methods of carrying the signalling channel in DPNSS networks.

Although not strictly part of the definition of DPNSS 1, in order to ease the problems of ensuring that PBXs from different manufacturers can interwork satisfactorily, it is also necessary to recommend standardised implementations of traffic channels.

SECTION 2, ANNEX 1 and ANNEX 4 describe how signalling can be carried via CCITT standard primary rate interfaces. These standards also define the characteristics of the traffic channels and are therefore the preferred implementations of traffic and signalling channels in DPNSS 1 networks.

Where a primary rate interface is not available, or use of a primary rate interface is not appropriate (eg insufficient traffic), alternative means of providing a signalling channel and the associated traffic channels may be employed.

SECTION 2, ANNEX 2 describes a means of carrying signalling on a rate adapted 64 kbit/s leased digital circuit using an X.21 bis interface, or via V series modems on 2-wire or 4-wire analogue leased circuits. Similar leased circuits could be used for the corresponding traffic channels, however, the characteristics of these circuits are not defined in this specification.

SECTION 2, ANNEX 3 describes a means of carrying signalling on a 64 kbit/s leased digital circuit using an X.21 interface, optionally with rate adaptation. Similar leased digital circuits or, alternatively, leased analogue circuits, could be used for the corresponding traffic channels, however, the characteristics of these circuits are not defined in this specification.

2.3 OUTLINE OF OPERATION

The signalling procedures are dealt with in two parts:

- Call Set-Up
- Call Clear Down

The general sequences for a successful call including variations to cover call failure conditions are given in paragraphs 2.3.1 and 2.3.2.

2.3.1 CALL SET - UP

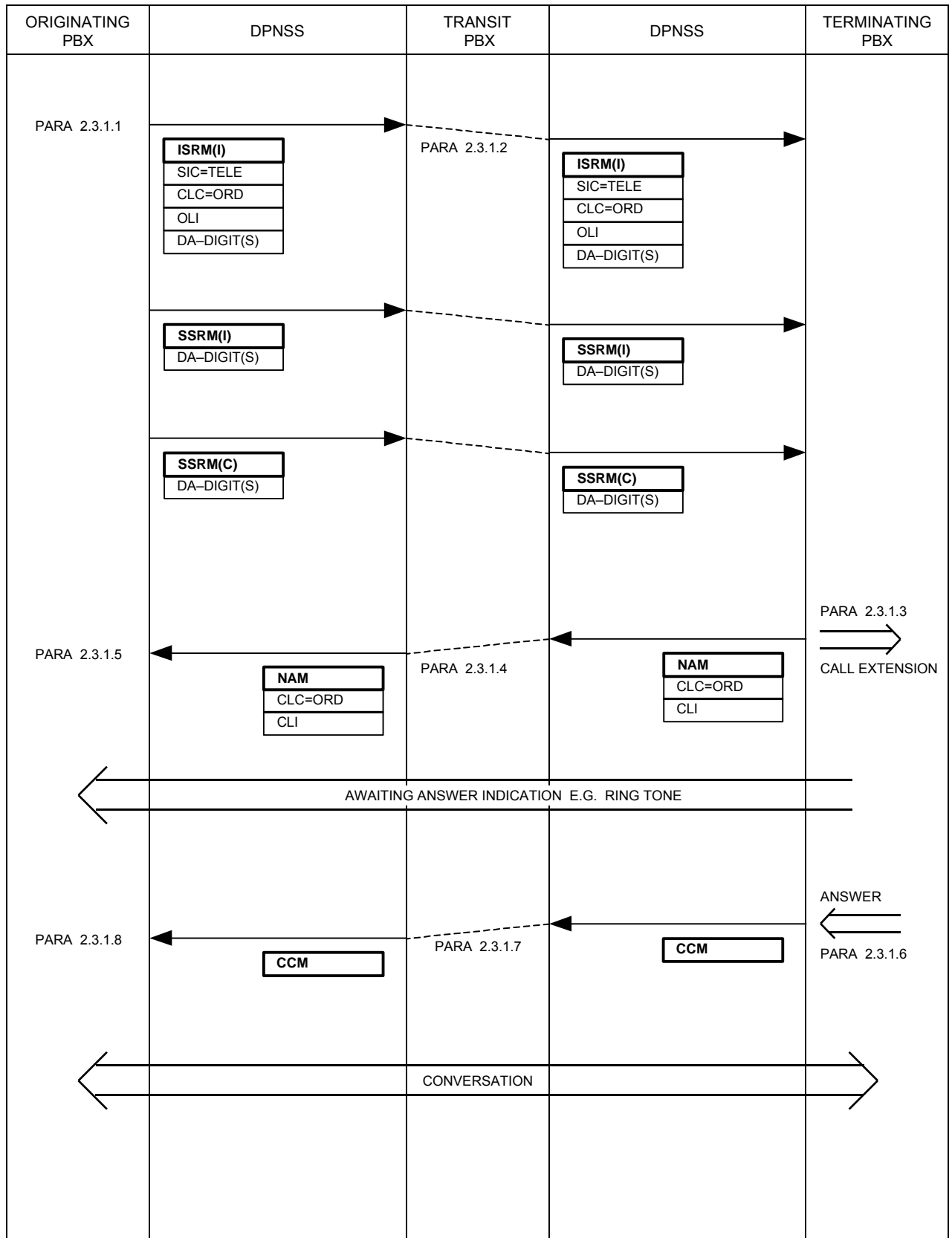

2.3.1.1 When a Simple Call is originated, and digit analysis indicates a DPNSS 1 route within a Private Network, a traffic channel shall be reserved and an Initial Service Request Message [ISRM(I) or ISRM(C)] shall be sent on the signalling channel.

If an ISRM(C) is used it shall contain a Service Indicator Code (SIC) and all of the Selection Block.

If an ISRM(I) is used it may be followed by one or more SSRMs [the last of which may be an SSRM(C)]. The ISRM(I) shall contain a Service Indicator Code (SIC) and all or part of the Selection Block.

The Selection Block [made up of the Selection Field of an ISRM(C) or the concatenated Selection Fields of an ISRM(I) and any SSRMs] shall contain the Calling Line Category (CLC), the Originating Line Identity (OLI) and, if any, the Destination Address (DA) digits.

The use of an ISRM(C) indicates End of Selection. If an ISRM(I) is used then End of Selection may subsequently be indicated by the sending of an SSRM(C). Where an SSRM(C) is used it shall contain the final part of the Selection Block unless there is no further selection information to be sent, in which case it shall be empty.

Where End of Selection can be determined by the Originating PBX and all of the information to be included in the Selection Block can be fitted into a single message, then the use of an ISRM(C) is normally preferred. Where it is known, however, that interworking with a slow speed signalling system may be encountered, then in order to reduce post dialling delays the use of an ISRM(I) and a series of SSRMs to convey digits as and when they are received may be more appropriate than storing them until an ISRM(C) can be sent.

Where End of Selection cannot be determined by the Originating PBX, then the use of an ISRM(I) is necessary. The ISRM(I) may be followed by one or more SSRMs.

Where all of the information to be included in the Selection Block cannot be fitted into a single message (eg as a result of long addresses or the inclusion of Service Independent Strings [see SECTION 16]) then the information shall of necessity be split across the Selection Fields of an ISRM(I) and one or more SSRMs.

The transmission path should be connected through as soon as possible to enable any supervisory indications or announcements to be returned to the originating user.

NOTE: For the remainder of this specification, unless otherwise qualified, the term ISRM will be used to indicate any one of the following:

- an ISRM(C);
- an ISRM(I);
- an ISRM(I) and one or more SSRMs.

2.3.1.2 On receipt of an ISRM (see NOTE above) indicating an outgoing DPNSS 1 route, then a traffic channel shall be reserved on the outgoing route. An ISRM, including the same SIC and Supplementary Information Strings as received and any DA digits that are to be forwarded, shall be sent on the outgoing signalling channel.

If the outgoing DPNSS 1 route is not the first-choice route, a NIM should be sent back to the Originating PBX containing the String RTI (Routing Information) indicating alternative route. The String CAUSE may also be added to the NIM to indicate the condition that caused alternative routing to be invoked. The Parameter to CAUSE shall represent the Clearing Cause that would have been sent in a CRM had alternative routing not taken place. The information in the NIM may be used, for example, to invoke Route Optimisation (SECTION 19) or, to provide display information to the caller.

The transmission path should be connected through as soon as possible to enable any supervisory indications or announcements to be returned to the originating user.

If the Transit PBX is unable to route the call then a CRM containing one of the following Clearing Causes, as appropriate, shall be sent towards the Originating PBX and a CIM shall be expected in response:

- Access Barred (AB)
- Address Incomplete (AI)
- Channel Out of Service (CHOS)
- Congestion (CON)
- Service Incompatible (INC)
- Network Termination (NT)
- Number Unobtainable (NU)
- Route Out of Service (ROS)

2.3.1.3 On receipt of an ISRM identifying a user extension which is free, and if the connection is allowed, then the extension shall be called, Awaiting Answer Indication shall be returned in the traffic channel and a Number Acknowledge Message (NAM) containing the Called Line Category and the Called Line Identity shall be returned in the signalling channel.

Following the sending of the NAM any further SSRMs received shall be ignored.

If the Terminating PBX is unable to present the call then a CRM containing one of the following Clearing Causes, as appropriate, shall be sent towards the Originating PBX and a CIM shall be expected in response:

- Address Incomplete (AI)
- Busy (BY)
- Channel Out of Service (CHOS)
- Congestion (CON)
- Incoming Calls Barred (ICB)
- Network Termination (NT)
- Number Unobtainable (NU)
- Subscriber Incompatible (SI)
- Subscriber Out of Service (SOS)

2.3.1.4 On receipt of a NAM from the outgoing channel, the Transit PBX shall send a NAM (including the same contents) on the incoming channel towards the Originating PBX and the incoming and outgoing traffic channels shall be connected in the backward direction (if not already connected).

If instead a CRM is received from the outgoing channel then a CIM shall be returned in response and, if the call is not to be alternatively routed, a CRM (including the same contents) shall be sent on the incoming channel towards the Originating PBX and a CIM shall be expected in response.

If the Clearing Cause received in the CRM indicates that the call might succeed if re-routed (eg Clearing Cause: CON) then a further attempt to select an outgoing channel may be made as described in paragraph 2.3.1.2.

If the attempt at alternatively routing the call fails, as indicated by receipt of a CRM from the outgoing channel, either clearing or further alternative routing shall be carried out as described in SECTION 5, paragraph 3.2.3.

2.3.1.5 Receipt of a NAM containing either CLC-ORD or CLC-OP, and CLI indicates that the called party is being alerted and that Awaiting Answer Indication is being returned in the traffic channel. No further SSRMs shall be sent as part of this selection sequence.

If instead of a NAM a CRM is received, a CIM shall be sent in response. Subsequent action (eg alternative routing or call failure indication) may depend on the Clearing Cause.

2.3.1.6 On receipt of an answer signal the Terminating PBX shall return a Call Connected Message (CCM) in the signalling channel and connect the answering extension to the incoming traffic channel in both directions. The CLC and CLI of the answering extension may be included in the CCM (eg to indicate that the call has been answered by a device other than the one indicated in the NAM).

2.3.1.7 On receipt of a CCM from the outgoing channel, the Transit PBX shall send a CCM (including the same contents) on the incoming channel towards the Originating PBX and the incoming and outgoing traffic channels shall be connected in both directions (if not already connected).

If instead a CRM is received from the outgoing channel then a CIM shall be returned in response. A CRM (including the same contents) shall be sent on the incoming channel towards the Originating PBX and a CIM shall be expected in response.

2.3.1.8 On receipt of a CCM the originating extension shall be connected to the outgoing channel in both directions (if not already connected). An Answer Indication may be sent to the originating extension if appropriate.

If instead of a CCM a CRM is received a CIM shall be sent in response. Subsequent action (eg call failure indication) may depend on the Clearing Cause.

2.3.2 CALL CLEAR DOWN

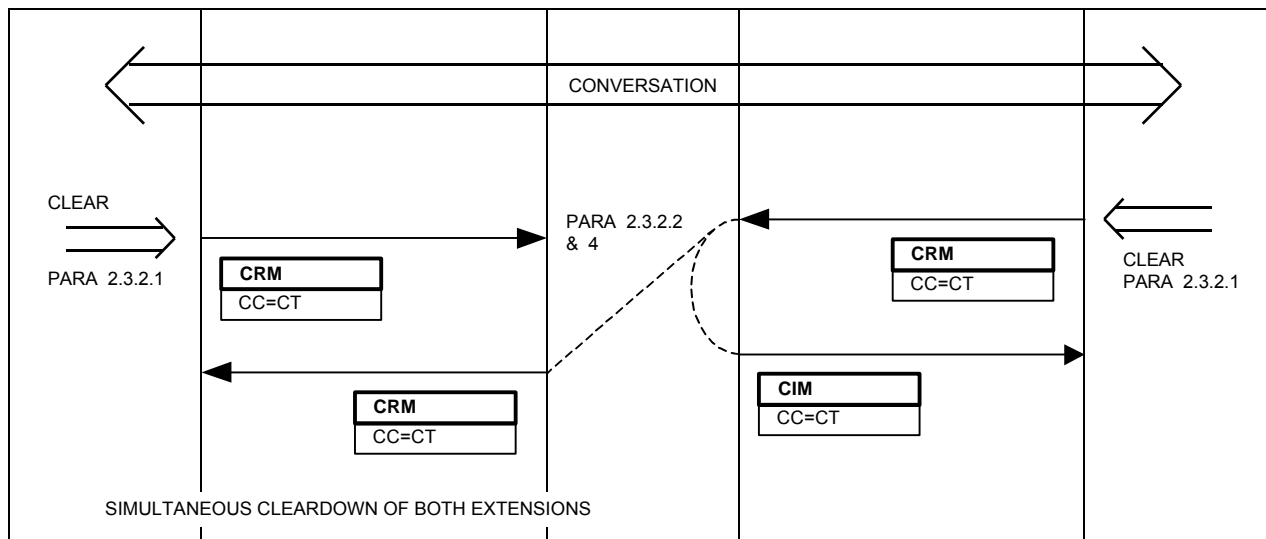
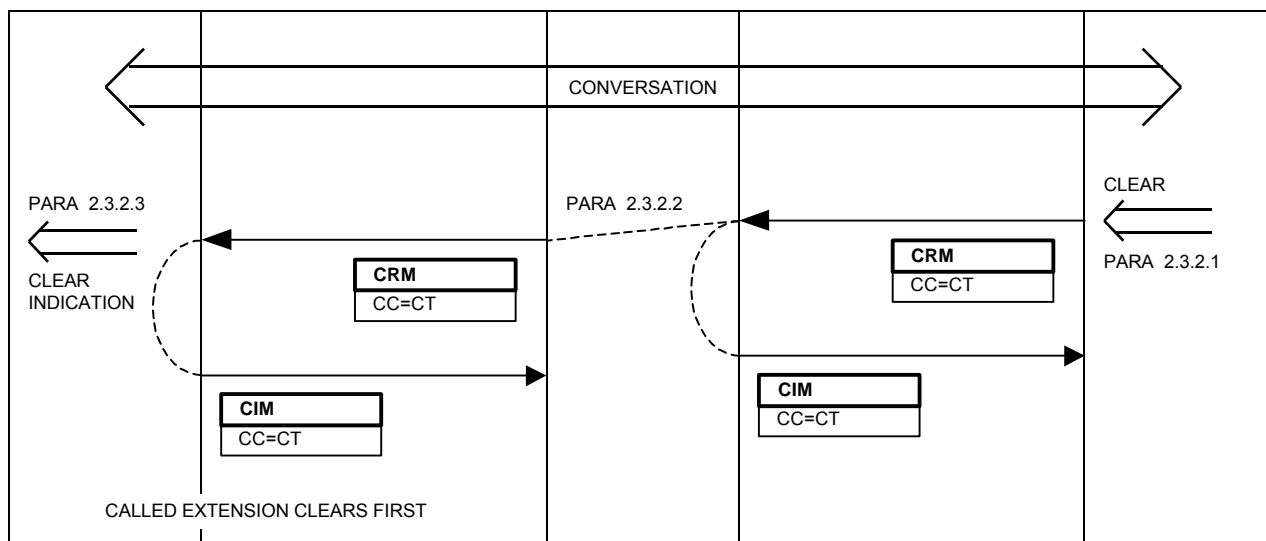
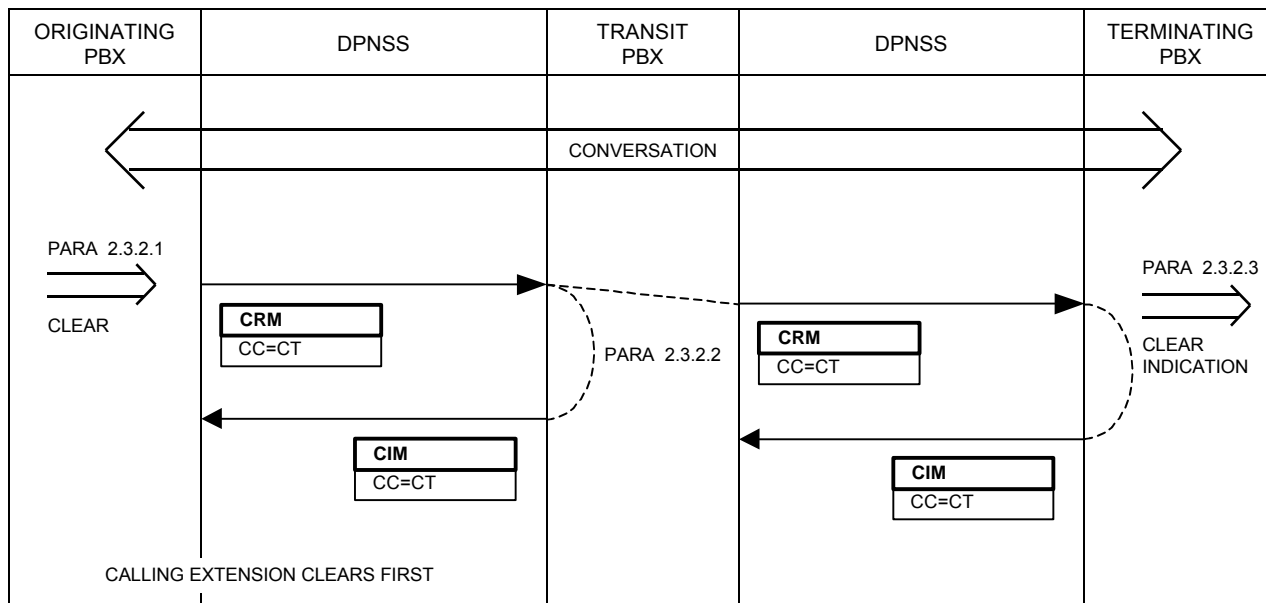

2.3.2.1 DPNSS 1 uses a symmetrical clearing sequence. When a clear signal is received from an originating or terminating extension, the traffic channel shall be disconnected and the call shall be released by sending a Clear Request Message (CRM). A Clear Indication Message (CIM) shall be expected in response.

2.3.2.2 DPNSS 1 uses a link by link clearing sequence. At a Transit PBX when a CRM is received on an Incoming or Outgoing signalling channel, the traffic channel shall be disconnected, the call released and a CIM shall be returned in response. A CRM (including the same contents) shall be relayed on and a CIM shall be expected in response.

2.3.2.3 At an end PBX when a CRM is received on an Incoming or Outgoing signalling channel the traffic channel shall be disconnected, the call released and a CIM shall be returned in response. A clear indication may be sent to the extension.

2.3.2.4 As both ends of a DPNSS 1 call can initiate the clearing sequence CRMs may cross. Since the group and type codes for CRM and CIM are identical, both ends will deduce that the received message is a CIM. However, the contents of the received message may not match the contents of the transmitted CRM (eg the Clearing Causes may differ); thus, if a CRM has been sent then a received CRM/CIM shall always be treated as a valid response regardless of the contents of the Clearing Cause and Indication Fields.

3 SDL DIAGRAMS

FIGURE 1 Service Process: Simple Telephony Call at
 Originating PBX

FIGURE 2 Service Process: Simple Telephony Call at
 Transit PBX

FIGURE 3 Service Process: Simple Telephony Call at
 Terminating PBX

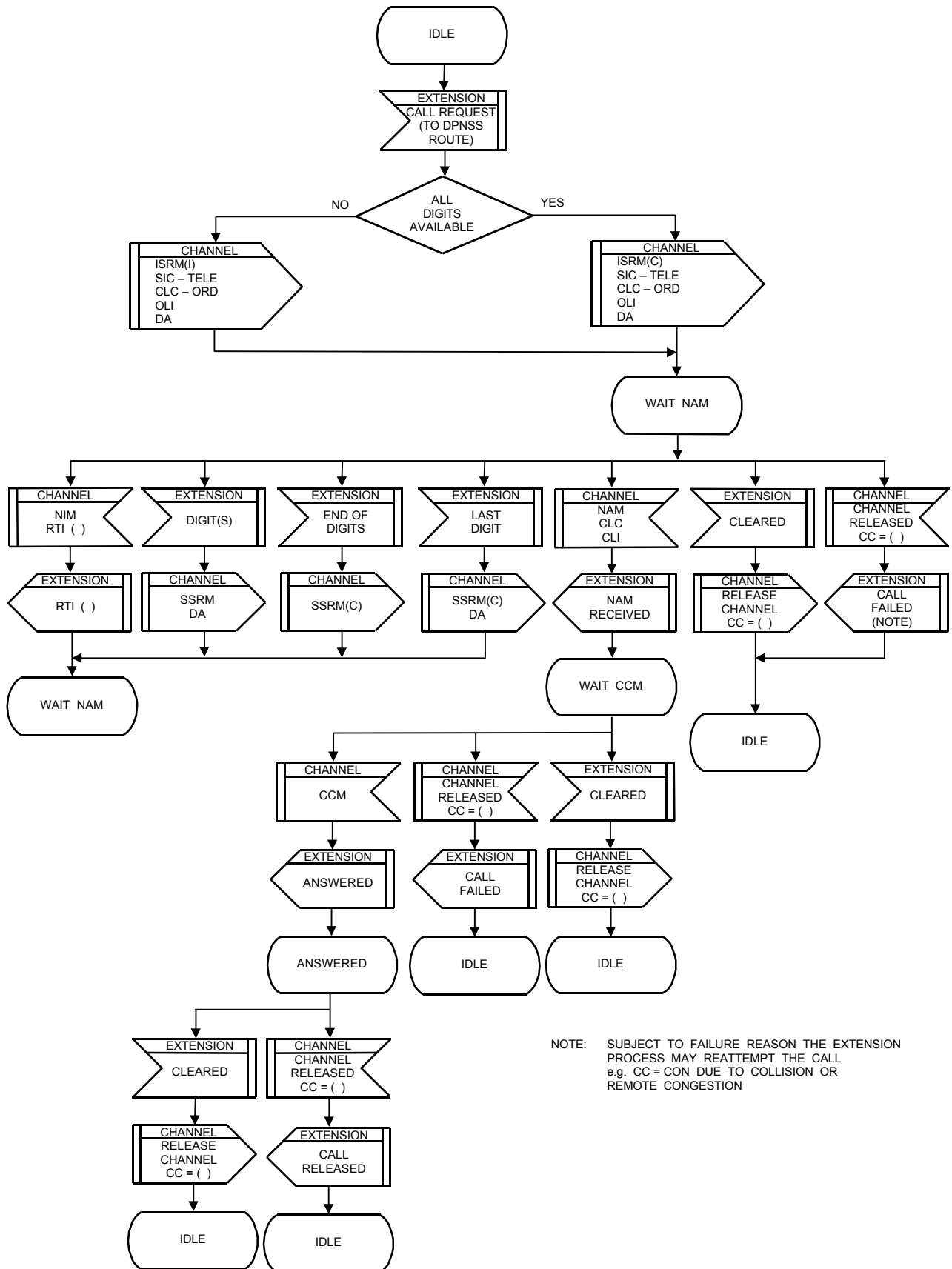

SERVICE PROCESS: SIMPLE TELEPHONY CALL AT ORIGINATING PBX
FIG. 1 (DPNSS[188] SECTION 6)

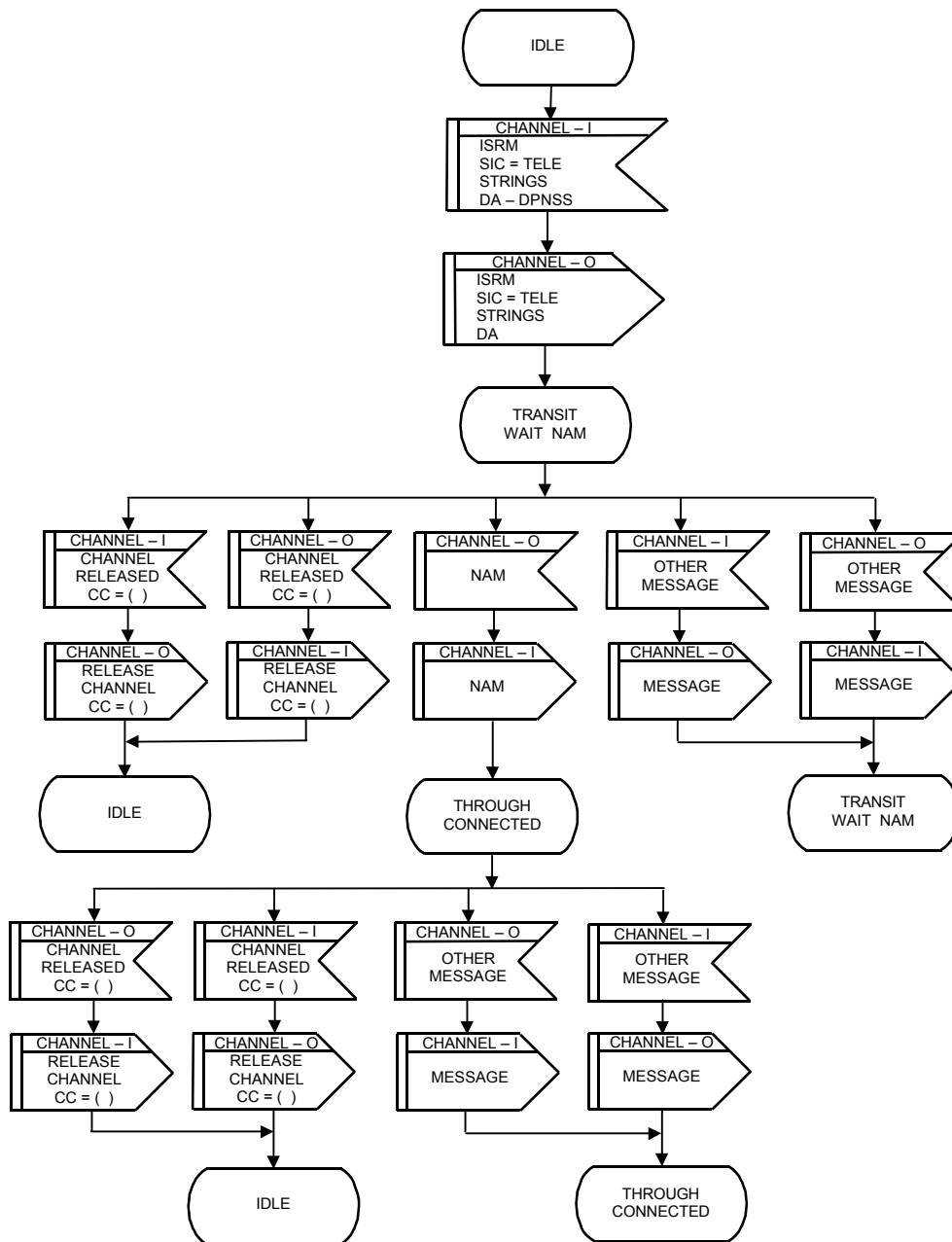

SERVICE PROCESS: SIMPLE TELEPHONY CALL AT TRANSIT PBX
FIG. 2 (DPNSS[188] SECTION 6)

NOTE:

THE RECEIVED SIC IS INPUT TO AND CHECKED FOR COMPATIBILITY IN THE EXTENSION PROCESS. FAILURE OF THE COMPATIBILITY CHECK WOULD BE ONE REASON FOR CALL REJECTION. OTHER REASONS FOR CALL REJECTION INCLUDE EXTENSION BUSY, ETC.

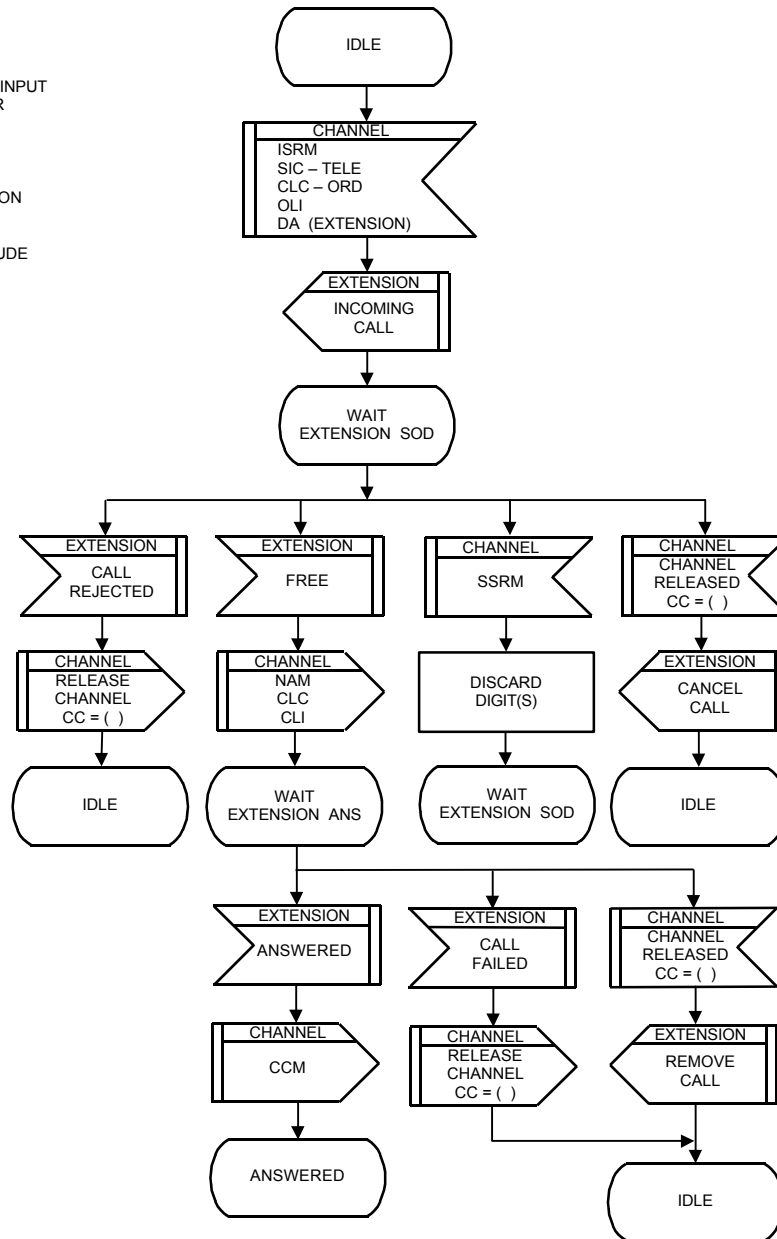

SERVICE PROCESS: SIMPLE TELEPHONY CALL AT TERMINATING PBX
FIG. 3 (DPNSS[188] SECTION 6)

4 COMPLIANCE SHEET FOR THE SIMPLE TELEPHONY CALL

Provision of, at least, either the Simple Telephony Call or the Circuit Switched Data Call is mandatory in a DPNSS 1 network.

For a PBX to provide the Simple Telephony Call in DPNSS 1 it must comply with at least one of the service variants in TABLE 1.

TABLE 1 should be completed by a manufacturer to indicate the PBX capability and by a purchaser to indicate PBX requirements.

TABLE 1

COMPLIANCE TABLE FOR A PBX THAT SUPPORTS THE SIMPLE TELEPHONY CALL		
SERVICE VARIANT		COMMENT
Able to originate Simple Telephony Calls		
Able to receive Simple Telephony Calls		
Able to act as a Transit PBX for Simple Telephony Calls		

DIGITAL PRIVATE NETWORK SIGNALLING SYSTEM NO 1 (DPNSS 1)

SECTION 7 - CIRCUIT SWITCHED DATA CALLS

CONTENTS

1	GENERAL	Page 2
2	CIRCUIT SWITCHED DATA CALLS WITHIN DPNSS 1	Page 3
2.1	DEFINITION	Page 3
2.2	DESCRIPTION	Page 3
2.2.1	General.....	Page 3
2.2.2	Rate Adaptation.....	Page 3
2.2.3	Use of Analogue Traffic Channels for Data.....	Page 4
2.3	OUTLINE OF OPERATION	Page 4
2.3.1	Generalised Circuit Switched Data Call....	Page 5
2.3.2	X21 DTE - X21 DTE (Direct or Addressed Call).....	Page 8
2.3.3	X21 DTE - X21 DTE (Leased Circuit).....	Page 10
2.3.4	X21 bis DTE - X21 bis DTE.....	Page 12
3	SDL DIAGRAMS	Page 14
4	COMPLIANCE	Page 18

HISTORY

Issue 1 - May 1983
Issue 2 - February 1984
Issue 3 - September 1984
Issue 4 - March 1986
Issue 5 - December 1989

Issue 6 - March 2001 - Specification renamed as DPNSS[188]
- SDL Diagrams added

REFERENCES

Standard ECMA 102

1 GENERAL

1.1 This Section details the signalling requirements of DPNSS 1 for Circuit Switched Data Calls.

1.2 Subsection 2 details Circuit Switched Data Calls within a DPNSS 1 network, and comprises two parts:

- a generalised Circuit Switched Data Call

and

- examples of sequences showing Circuit Switched Data Calls between some commonly used data types.

1.3 Subsection 3 details a Circuit Switched Data Call in SDL format.

1.4 Subsection 4 shows the Compliance.

1.5 The description is given in the form of Message Sequence Diagram (MSDs) followed by explanatory text.

1.6 The text is referenced from MSDs at appropriate points in the sequences.

1.7 Message contents for successful calls are shown in MSDs. Alternative action (eg for unsuccessful calls) not shown in MSDs is included in the text for the Generalised Call.

1.8 Coding of the contents of messages is given in SECTION 4.

2 CIRCUIT SWITCHED DATA CALLS WITHIN DPNSS 1

2.1 DEFINITION

The DPNSS 1 Circuit Switched Data Calls provide facilities for establishing connections between any DPNSS 1 network terminals having compatible data communication capabilities.

2.2 DESCRIPTION

2.2.1 General

This subsection only deals with simple Data Calls which originate and terminate at terminals connected to a PBX in a DPNSS 1 network.

NOTE: For recommendations on the physical characteristics of traffic channels see SECTION 6, Paragraph 2.2.

Each PBX along the call path should choose a suitable path based on the Service Indicator Code (SIC).

NOTE: If "Flow Control" is indicated in the SIC, the selected path must not be analogue.

A Data Call shall be non-interruptible for the duration of the call at every PBX along its path.

Examples of calls originating and terminating at the following terminal types are specified:

CCITT V series DTE

CCITT X series DTE

This list is not intended to be exhaustive but to indicate the general types of terminal between which DPNSS 1 Circuit Switched Data Calls can be established. Interconnection of different terminal types is possible providing they operate in the same mode and at the same speed.

eg it is possible to interconnect an X21 (isochronous) Data Terminal Equipment (DTE) with an X21 bis (isochronous) DTE operating at 2400 bit/s.

2.2.2 Rate Adaptation

In order that a variety of data transmission speeds can be catered for and transported within the standard 64 kbit/s traffic channels a standard rate adaptation method is proposed for use with DPNSS 1.

The rate adaptation requirements recommended for DPNSS 1 are specified in Standard ECMA 102.

2.2.3 Use of Analogue Traffic Channels for Data

Data may be carried on analogue traffic channels by means of Modems. The information in the SIC can be used by a PBX to determine the speed and type of Modem required; such a Modem may be selected from a Modem pool and switched into the channel when required.

In transit situations where the incoming route is digital and the outgoing route is analogue (or vice-versa) the information in the SIC can additionally be used to determine the type of rate adaptation and interface conversion equipment required; again such equipment may be selected from a pool and switched into the channel as required. The SIC shall be repeated without change.

In transit situations where both incoming and outgoing routes are analogue no Modem switching, rate adaptation or interface conversion equipment are required. The SIC should be repeated to the next link unchanged.

NOTE: CUSTOMERS SHOULD ENSURE THAT ALL MODEMS USED FOR DATA CALLS ARE COMPATIBLE ON THE LINE SIDE; THIS IS A NETWORK-WIDE REQUIREMENT.

2.3 OUTLINE OF OPERATION

A message sequence for a generalised Circuit Switched Data Call is described in paragraph 2.3.1. This is followed by a number of message sequences for the commonly used circuit switched data terminal interfaces referenced in ECMA Standard 102.

The message sequences given are not intended to be the only permissible ones for particular interface types. They are given to illustrate the normal mode of operation of Circuit Switched Data Calls. The clear-down sequences shall be as shown in Paragraph 2.3.2 of SECTION 6.

2.3.1 GENERALISED CIRCUIT SWITCHED DATA CALL

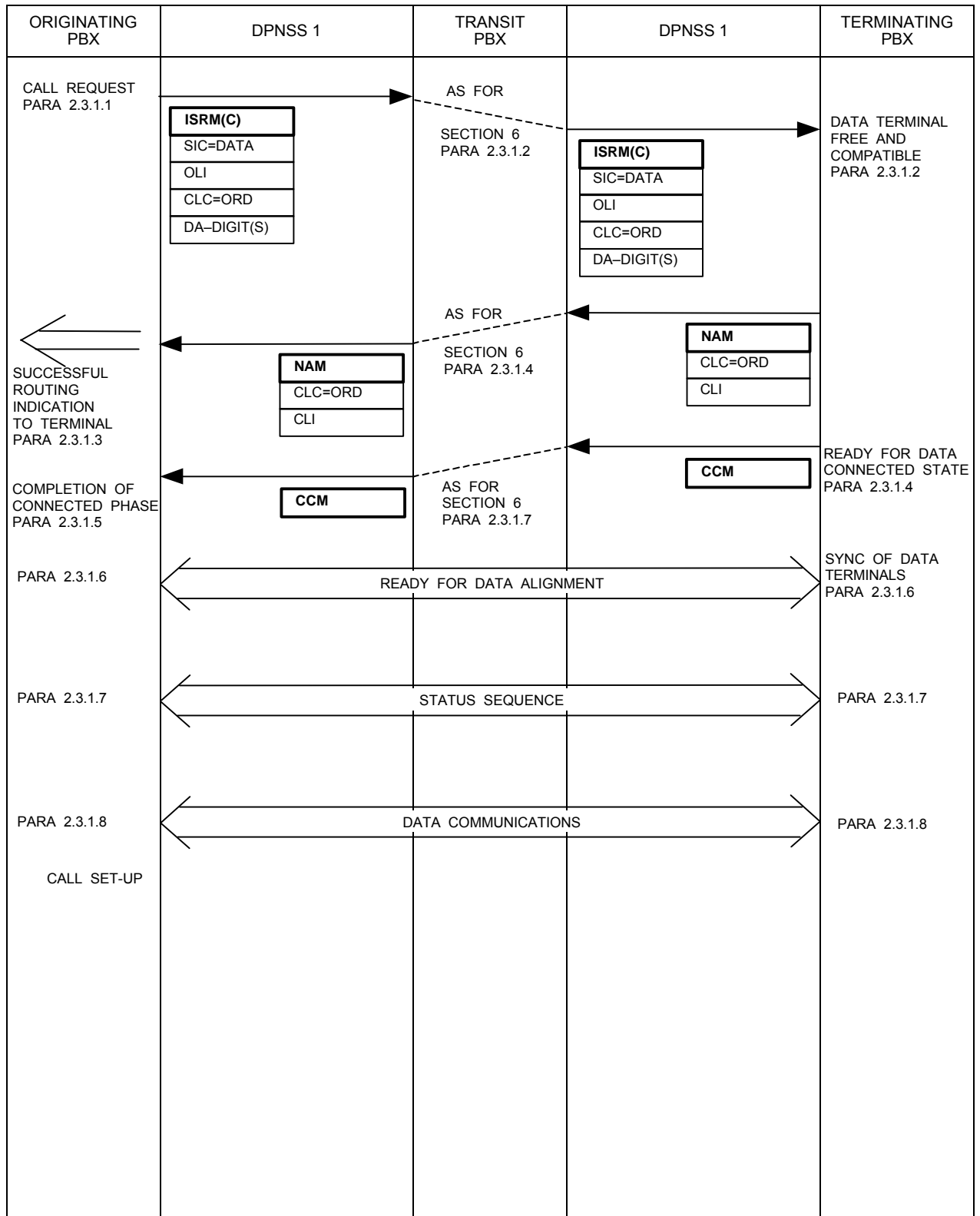

2.3.1.1 The first message on all Circuit Switched Data Calls is an ISRM. This message contains a Service Indicator Code (SIC), Calling Line Category (CLC), Destination Address (DA) and if available the Originating Line Identity (OLI).

The SIC indicates the method of rate adaptation used for the data communication phase, the source rate of the data and also whether it is isochronous or anisochronous.

The Destination Address may have been provided by the data terminal or from a separate keypad, or it may have been a predetermined number stored within the PBX.

2.3.1.2 On receipt of an ISRM the action at the DPNSS 1 terminating PBX is dependent upon the type of Network Terminal identified by the Destination Address.

If the Destination Address identifies a data terminal which is free and the connection is allowed and the terminal is compatible with the service indicated in the ISRM SIC, then the call should be presented to the terminal. If the call is accepted then a NAM containing the Called Line Identity (CLI) and its Called Line Category (CLC) should be returned in the signalling channel.

In the event of the following call failure conditions a CRM should be sent containing the appropriate Clearing Cause:

- Number Unobtainable
- Address Incomplete
- Subscriber Incompatible
- Congestion
- Busy
- Subscriber Out of Service
- Incoming Calls Barred
- DTE Controlled not ready
- DTE Uncontrolled not ready

2.3.1.3 Receipt of a NAM containing no Supplementary Service Information other than CLC and CLI indicates a successful routing and an appropriate indication can be given to the Originating Network Terminal.

In the case of a call failure a CRM with the appropriate Clearing Cause will be used to drop the call back to the Originating DPNSS 1 PBX from which an appropriate call failure indication will be given to the Originating Data Terminal. A CIM will be sent in response to this CRM.

If the CRM from the succeeding PBX indicates congestion in the Clearing Cause then a transit PBX could attempt to route the call via an alternative route.

2.3.1.4 When the terminating DPNSS 1 PBX is ready to enter the connected state a Call Connected Message (CCM) will be sent on the signalling channel. This will normally follow the sending of the DCE-provided information to the data terminal.

2.3.1.5 Receipt of a CCM indicates completion of the connection phase.

2.3.1.6 At this point the Originating and Terminating PBXs should attempt to synchronise the data terminals via the traffic channel. Further details of this process are in Standard ECMA 102.

2.3.1.7 Some rate adaptation methods will provide a status channel for use with certain types of isochronous data terminals (eg X21 and X21 bis); see also Standard ECMA 102.

2.3.1.8 Once the two terminal PBXs have achieved synchronisation and the terminals have exchanged status, if appropriate, then the data communication phase can be entered allowing free interchange of data at the appropriate rate and in the appropriate mode (ie isochronous or anisochronous); see also Standard ECMA 102.

2.3.2 X21 DTE TO X21 DTE DIRECT OR ADDRESSED CALL

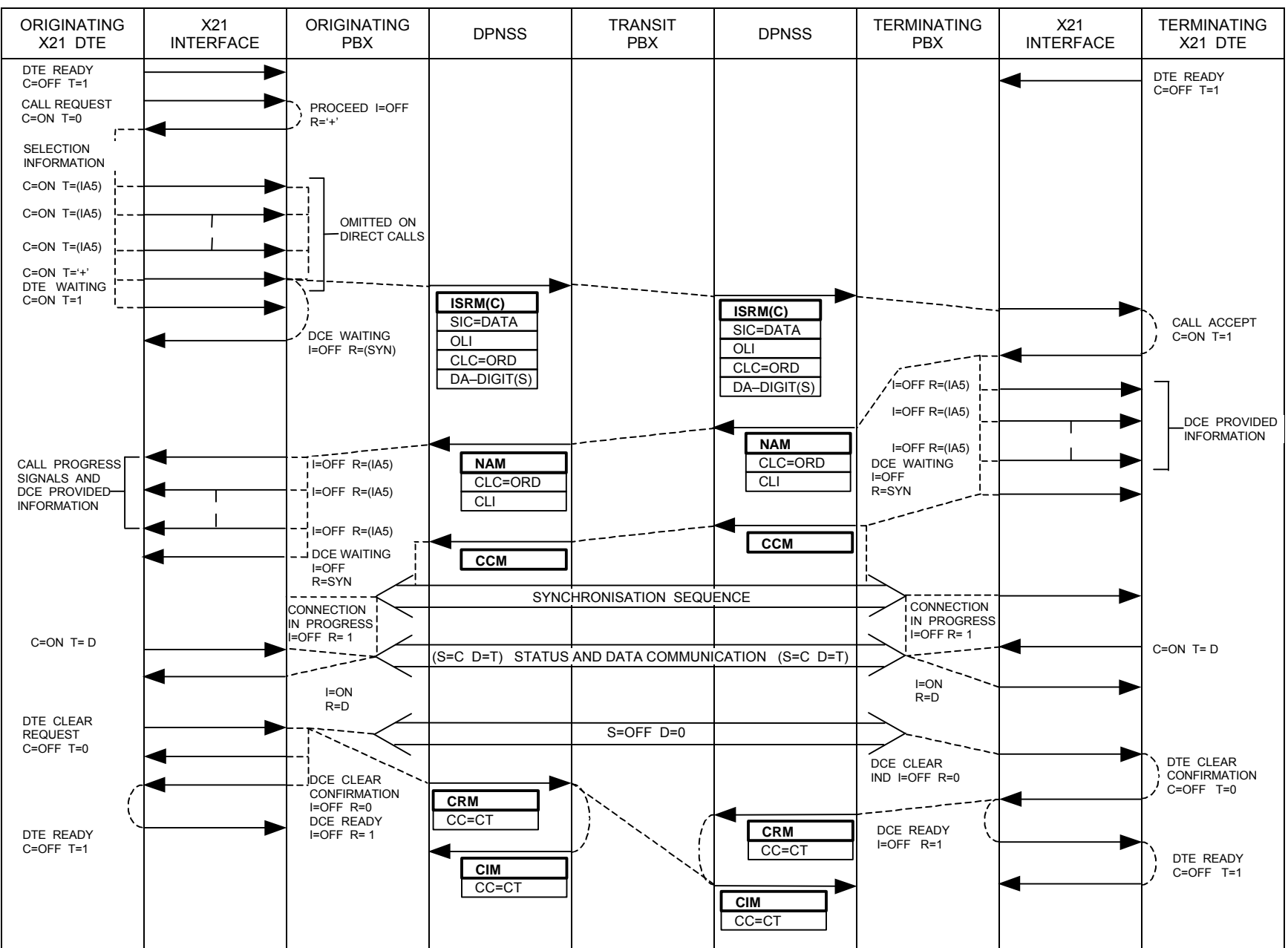

2.3.2.1 The clearing of the call is shown in SECTION 6 paragraph 2.3.2. The exact sequence is dependent upon the timings of the clearing messages across the network, and the speed of the rate adaptation scheme.

2.3.3 X21 DTE TO X21 DTE
LEASED CIRCUIT TERMINALS WITH CALL REQUEST AND RELEASE FROM A SEPARATE KEYBOARD

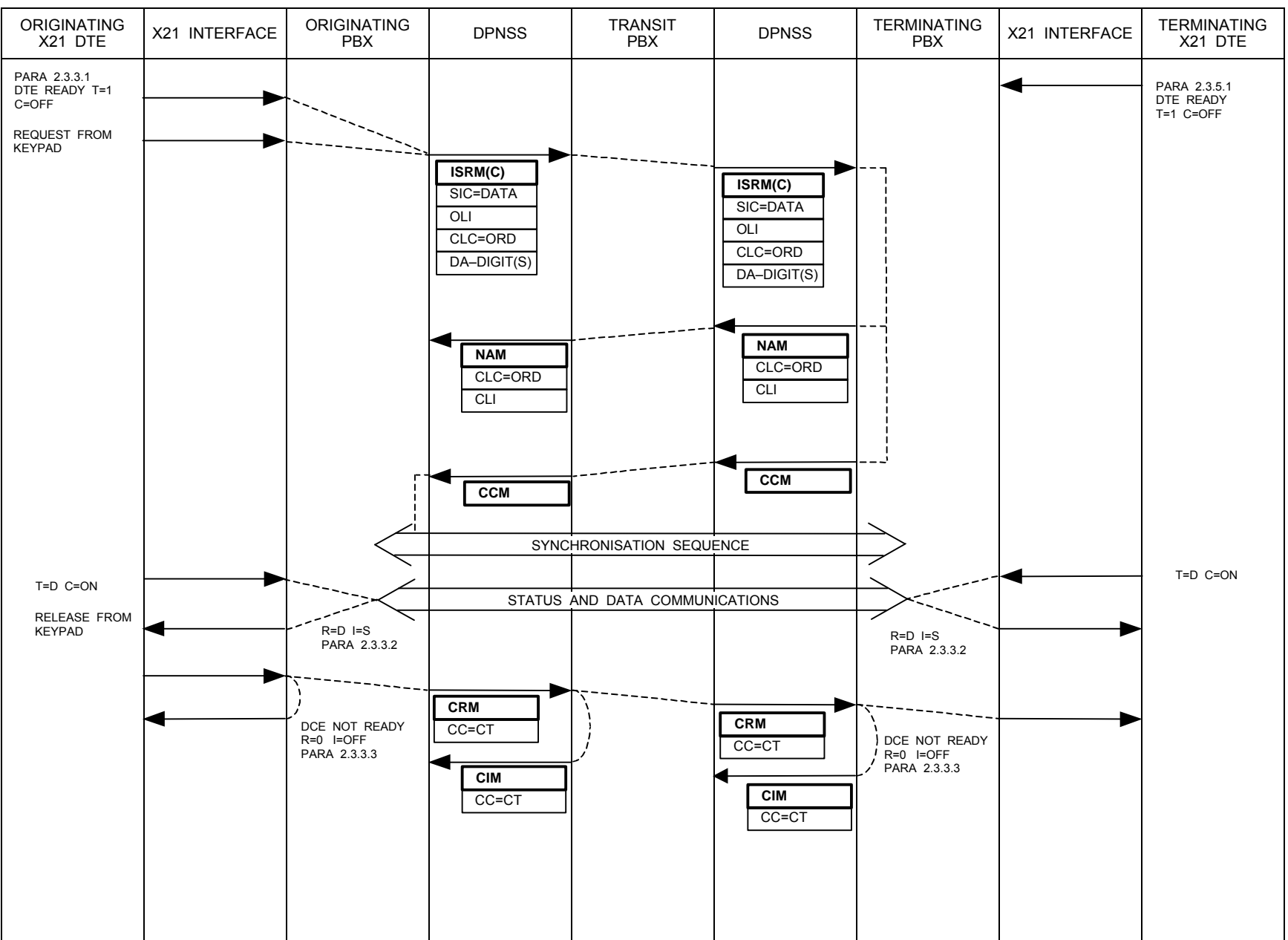

2.3.3.1 The DTE should also be treated as ready with C = ON and T = 0 or 1.

2.3.3.2 For 64 kbit/s user data rates there will be no facility for transporting an S bit in the traffic channel. Therefore, I will be set to ON once the synchronisation sequence is complete.

2.3.3.3 The DTE will be considered uncontrolled not ready until it returns to the ready state.

2.3.4 X21 bis DTE TO X21 bis DTE DIRECT CALL

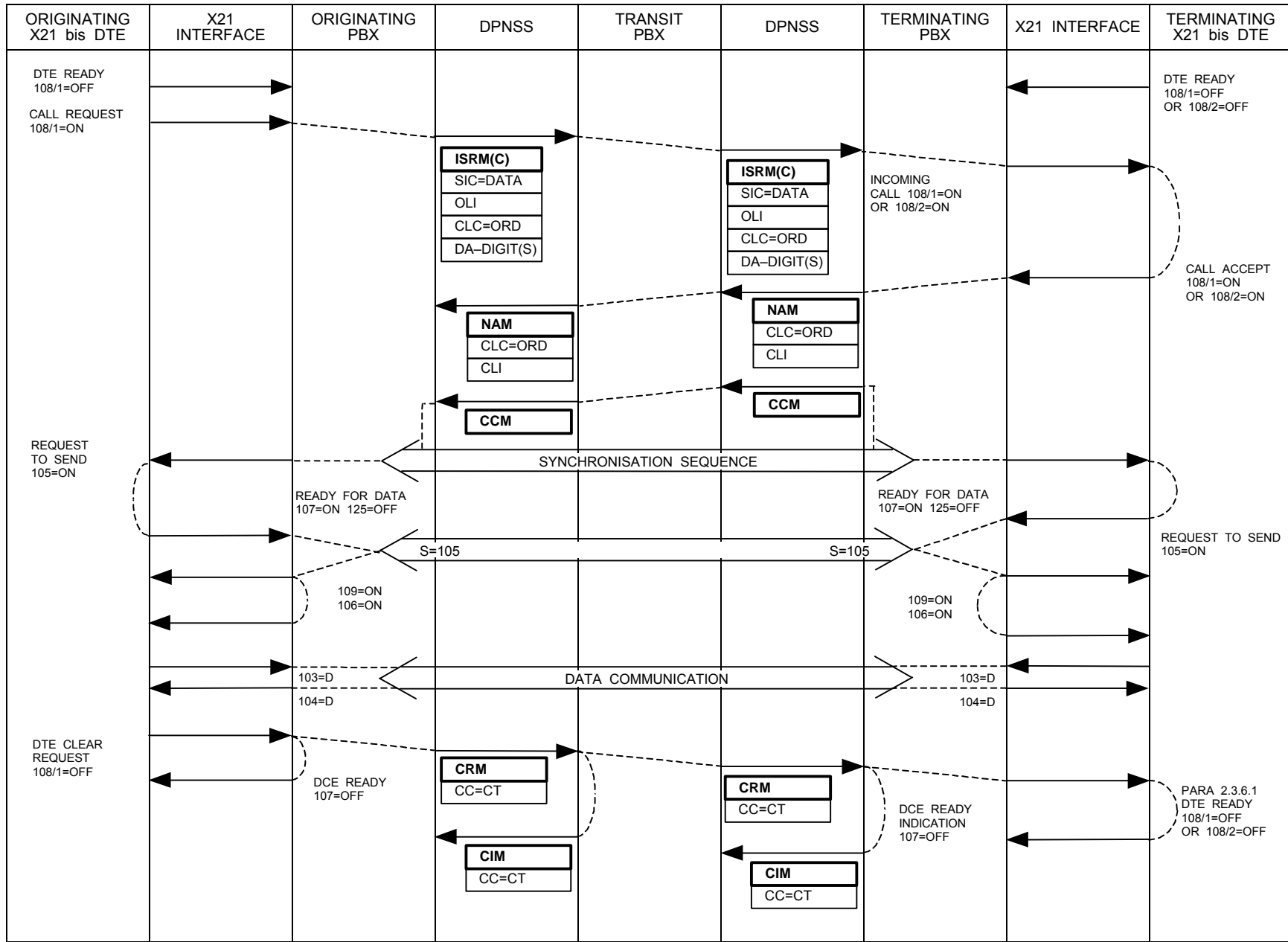

2.3.4.1 For terminals where Circuit 107 may go off only in response to DTE clear request the DTE should be considered as uncontrolled not ready until circuit 108 goes off.

3 SDL DIAGRAMS

FIGURE 1 Service Process: Circuit Switched Data Call at
 Originating PBX

FIGURE 2 Service Process: Circuit Switched Data Call at
 Transit PBX

FIGURE 3 Service Process: Circuit Switched Data Call at
 Terminating PBX

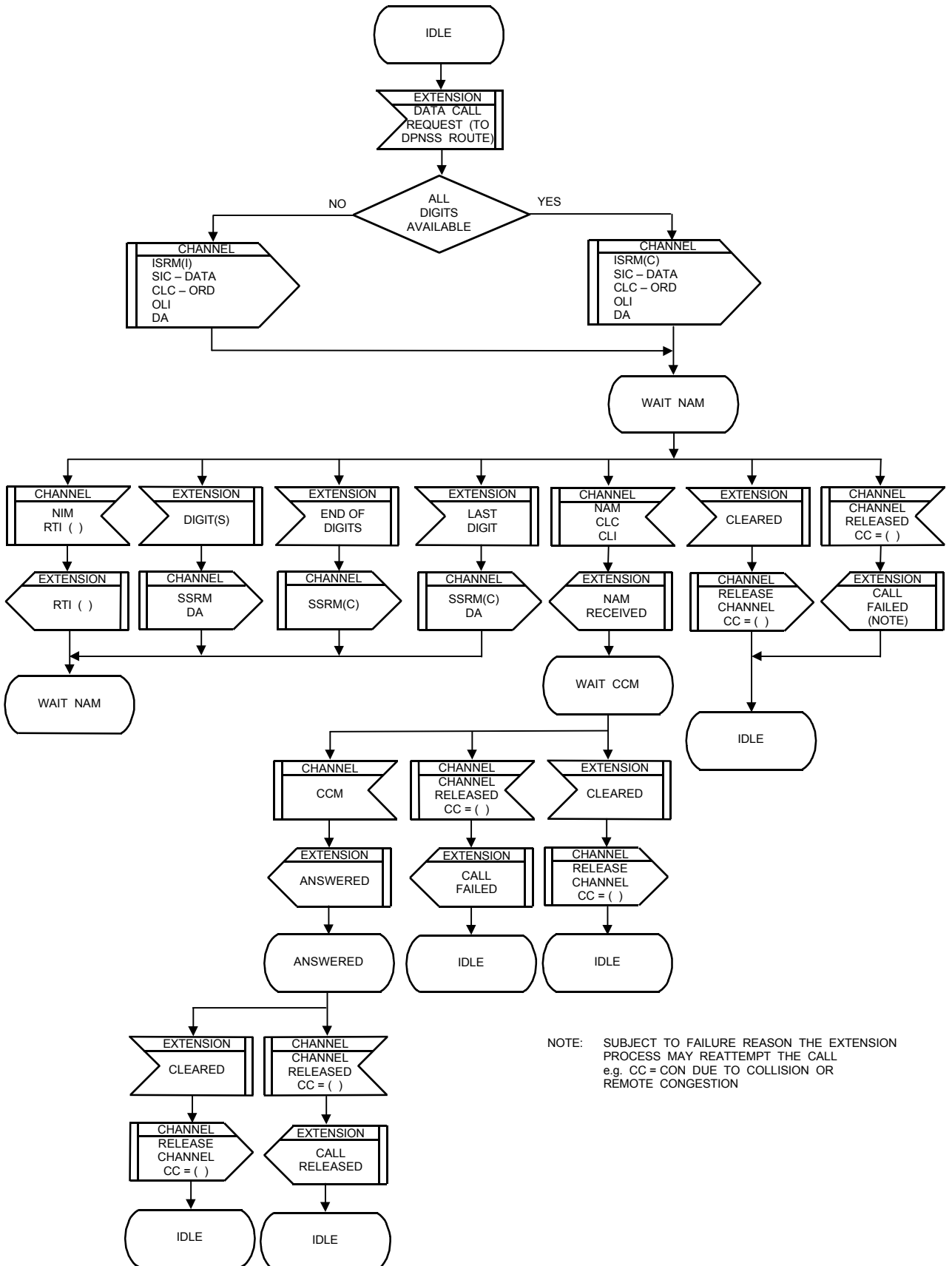

NOTE: SUBJECT TO FAILURE REASON THE EXTENSION PROCESS MAY REATTEMPT THE CALL e.g. CC = CON DUE TO COLLISION OR REMOTE CONGESTION

SERVICE PROCESS: CIRCUIT SWITCHED DATA CALL AT ORIGINATING PBX
FIG. 1 (DPNSS[188] SECTION 7)

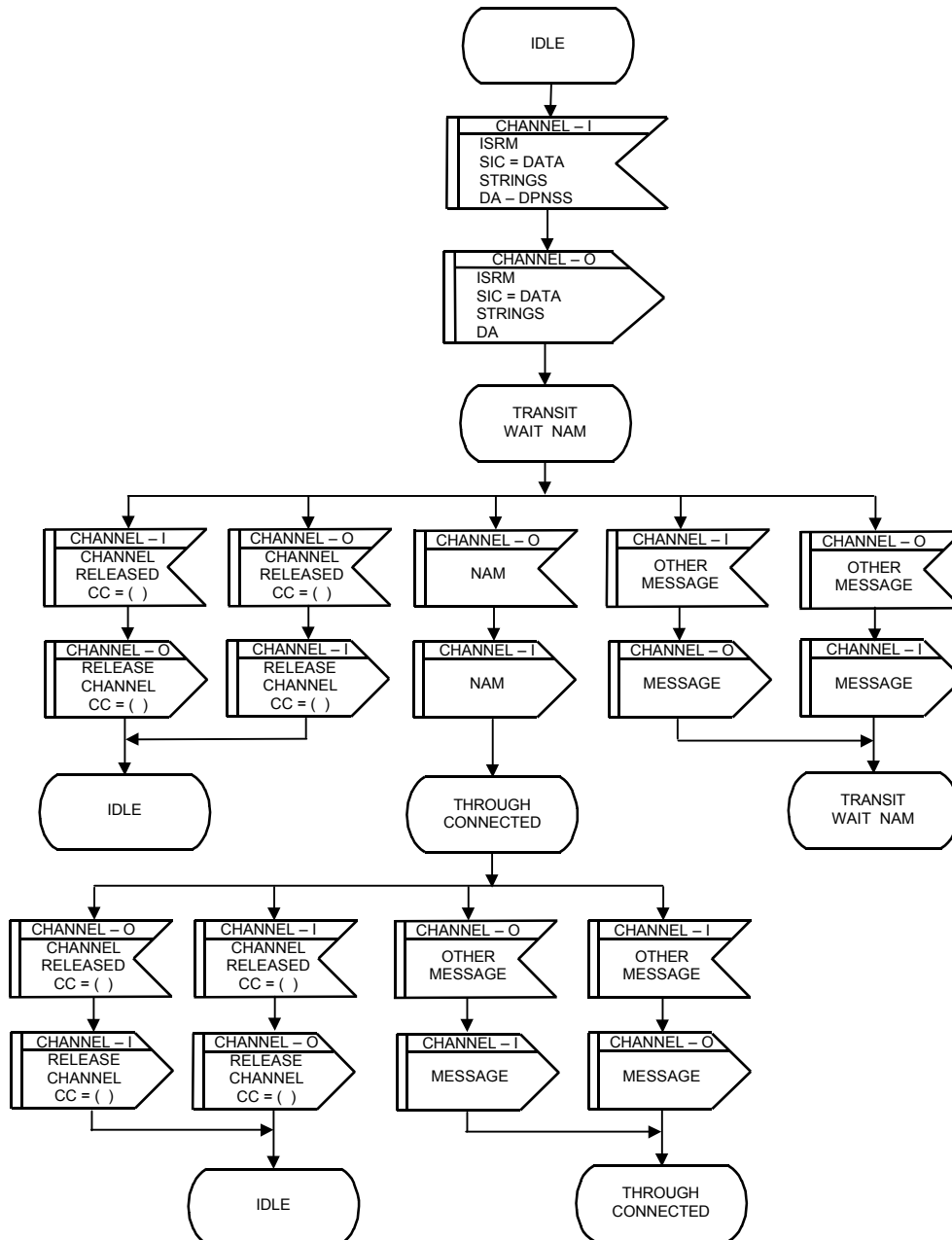

SERVICE PROCESS: CIRCUIT SWITCHED DATA CALL AT TRANSIT PBX
FIG. 2 (DPNSS[188] SECTION 7)

NOTE:

THE RECEIVED SIC IS INPUT TO AND CHECKED FOR COMPATIBILITY IN THE EXTENSION PROCESS. FAILURE OF THE COMPATIBILITY CHECK WOULD BE ONE REASON FOR CALL REJECTION. OTHER REASONS FOR CALL REJECTION INCLUDE EXTENSION BUSY, ETC.

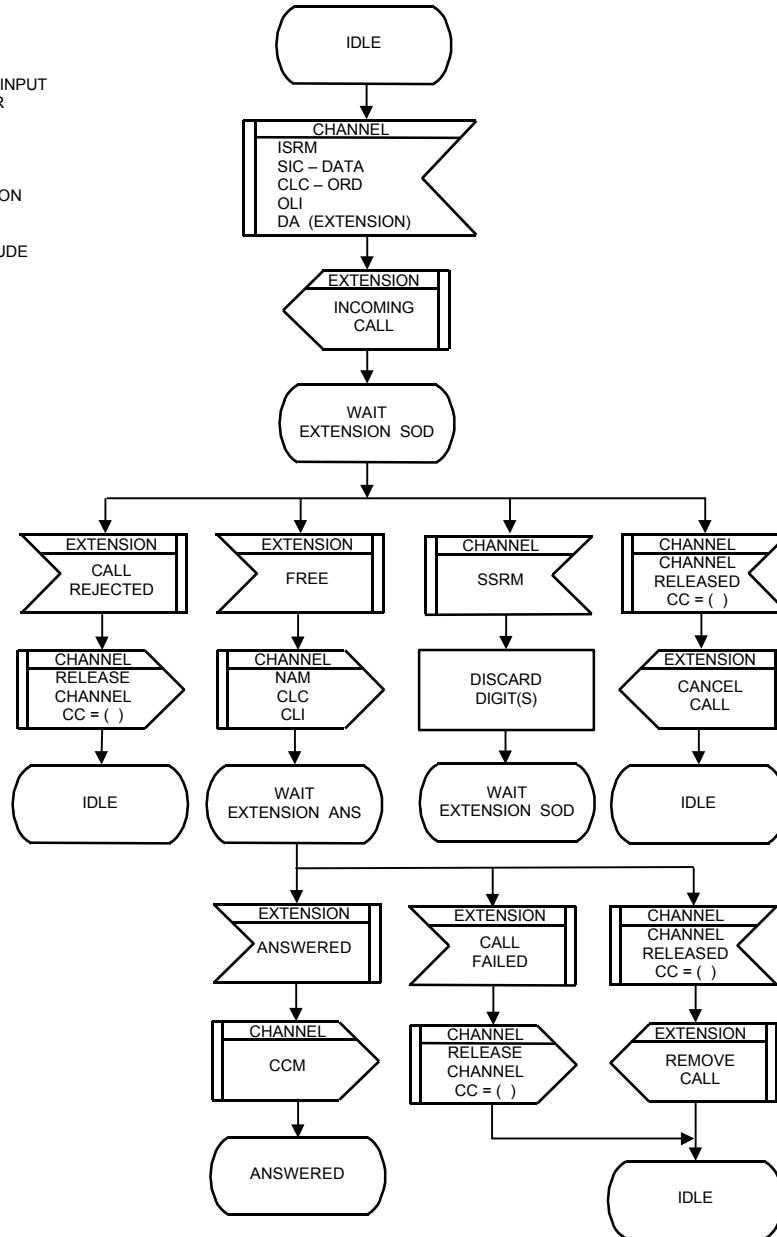

SERVICE PROCESS: CIRCUIT SWITCHED DATA CALL AT TERMINATING PBX
FIG. 3 (DPNSS[188] SECTION 7)

4 COMPLIANCE

Provision of at least, either the Simple Telephony Call or the Circuit Switched Data Call is mandatory in a DPNSS 1 network.

For a PBX to provide the Circuit Switched Data Call in DPNSS 1 it must comply with at least one of the options shown in TABLE 1.

Compliance with the service is considered in terms of the function(s) to be performed by the PBX ie Transit, End or Branching and the extent to which extensions on the PBX can request the service.

The options available are given in TABLE 1. This table should be completed by a manufacturer to indicate PBX capability and by a purchaser to indicate PBX requirements.

TABLES 2, 3 and 4 indicate the features that are required at each PBX.

TABLE 5 indicates the range of optional Data Service Indicator Codes to be supported by the PBX and any associated Terminal Adaptors (Digital Traffic Channels).

TABLE 6 indicates the range of optional Data Service Indicator Codes to be supported by the PBX and any associated Modems (Analogue Traffic Channels).

TABLE 7 indicates the range of optional Data Service Indicator Codes to be supported by the PBX and any associated Modems and Terminal Adaptors when acting as a Transit between Analogue and Digital Traffic Channels.

NOTE: When DPNSS 1 is used in conjunction with analogue traffic channels the customer must ensure that the modems used throughout the network are compatible on the line side.

TABLES 5, 6 and 7 should be completed by a manufacturer to indicate PBX capability and by a purchaser to indicate PBX requirements.

TABLE 1

COMPLIANCE TABLE FOR A PBX THAT SUPPORTS THE CIRCUIT SWITCHED DATA CALL		
SERVICE VARIANT		APPLICABLE TABLE
Able to originate Circuit-Switched-Data Calls?		TABLE 2
Able to receive Circuit-Switched-Data Calls?		TABLE 3
Able to act as a Transit for Circuit Switched Data Calls?		TABLE 4

TABLE 2

COMPLIANCE TABLE FOR A PBX WITH OPERATORS OR EXTENSIONS THAT ARE ABLE TO ORIGINATE CIRCUIT SWITCHED DATA CALLS		
SERVICE VARIANT		COMMENT
Able to originate Circuit Switched Data Calls via Digital Traffic Channels?		For Terminal SICs supported see TABLE 5
Able to originate Circuit Switched Data Calls via Analogue Traffic Channels?		For Terminal SICs supported see TABLE 6

TABLE 3

COMPLIANCE TABLE FOR A PBX WITH OPERATORS OR EXTENSIONS THAT ARE ABLE TO RECEIVE CIRCUIT SWITCHED DATA CALLS		
SERVICE VARIANT		COMMENT
Able to receive Circuit Switched Data Calls via Digital Traffic Channels?		For Terminal SICs supported see TABLE 5
Able to receive Circuit Switched Data Calls via Analogue Traffic Channels?		For Terminal SICs supported see TABLE 6

TABLE 4

COMPLIANCE TABLE FOR TRANSIT PBXs IN A NETWORK THAT SUPPORTS CIRCUIT SWITCHED DATA CALLS		
SERVICE VARIANT		COMMENT
Able to transit Circuit Switched Data Calls between Digital Traffic Channels?		A "YES" in this column implies that all SICs are supported
Able to transit Circuit Switched Data Calls between Analogue Traffic Channels?		A "YES" in this column implies that all SICs appropriate to analogue bearers are supported (see Note below)
Able to transit Circuit Switched Data Calls between Analogue and Digital Traffic Channels?		For Terminal SICs supported see TABLE 7

NOTE: The transit connection of analogue traffic channels does not involve connection of modems or terminal adaptors. Therefore the capability of supporting SICs is limited only by the capability of the voice band circuits and any modems provided at the End PBXs.

For each End PBX involved in a transit connection TABLE 6 may be used to indicate/request the SIC capability.

TABLE 5

COMPLIANCE TABLE FOR A PBX WITH DATA TERMINALS THAT SUPPORTS CIRCUIT SWITCHED DATA CALLS VIA DIGITAL TRAFFIC CHANNELS			
LIST OF TERMINAL SERVICE INDICATOR CODES SUPPORTED			
DATA RATE	OCTET 1	OCTET 2	REMARKS

NOTE: TABLE 5 indicates the range of optional Data SICs to be supported by the PBX and any associated Terminal Adaptors. The Table has, for ready reference, a column showing the data rate appropriate to the SIC For exact details of the data a type, mode, format, etc, reference should be made to SECTION 4, Annex 1 which gives full explanation of Service Indicator Codes. The remarks column may be used to indicate additional qualifying features of the SIC, eg synchronous, byte-timing, etc.

TABLE 6

COMPLIANCE TABLE FOR A PBX WITH DATA TERMINALS THAT SUPPORTS CIRCUIT SWITCHED DATA CALLS VIA ANALOGUE TRAFFIC CHANNELS			
LIST OF TERMINAL SERVICE INDICATOR CODES SUPPORTED			
DATA RATE	OCTET 1	OCTET 2	REMARKS

NOTE: TABLE 6 indicates the range of optional Data SICs to be supported by the PBX and any associated Modems. The Table has for ready reference, a column showing the data rate appropriate to the SIC. For exact details of the data type, mode, format, etc, reference should be made to SECTION 4, Annex 1 which gives full explanation of Service Indicator Codes. The remarks column may be used to indicate additional qualifying features of the SIC, eg synchronous, etc, or additional information eg Modem type.

TABLE 7

COMPLIANCE TABLE FOR A PBX IN A NETWORK THAT SUPPORTS CIRCUIT SWITCHED DATA CALLS WHEN ACTING AS A TRANSIT BETWEEN ANALOGUE AND DIGITAL TRAFFIC CHANNELS			
LIST OF TERMINAL SERVICE INDICATOR CODES SUPPORTED			
DATA RATE	OCTET 1	OCTET 2	REMARKS

NOTE: TABLE 7 indicates the range of optional Data SICs to be supported by the PBX and any associated Modems and Terminal Adaptors.

The Table has, for ready reference, a column showing the data rate appropriate to the SIC. For exact details of the data type, mode, format, etc, reference should be made to SECTION 4, Annex 1 which gives full explanation of Service Indicator Codes. The remarks column may be used to indicate additional qualifying features of the SIC, eg synchronous, byte timing, etc or additional information eg Modem type.

DIGITAL PRIVATE NETWORK SIGNALLING SYSTEM NO 1 (DPNSS 1)

SECTION 8 - SUPPLEMENTARY SERVICE: SWAP

CONTENTS

1	GENERAL	Page 2
2	SWAP SUPPLEMENTARY SERVICE WITHIN DPNSS 1	Page 3
	2.1 DEFINITION.....	Page 3
	2.2 DESCRIPTION.....	Page 3
	2.3 OUTLINE OF OPERATION.....	Page 3
	2.3.1 TELEPHONY TO X21 DATA TO TELEPHONY.....	Page 4
	2.3.2 TELEPHONY TO X21 bis TO TELEPHONY.....	Page 7
3	COMPLIANCE	Page 9

HISTORY

Issue 1 - May 1983
Issue 2 - February 1984
Issue 3 - September 1984
Issue 4 - March 1986
Issue 5 - December 1989

Issue 6 - March 2001 - Specification renamed as DPNSS[188]

1 GENERAL

1.1 This Section details the signalling requirements of DPNSS 1 for the Swap Supplementary Service.

1.2 Subsection 2 details the Swap Supplementary Service within DPNSS 1.

1.3 Subsection 3 shows the Compliance.

1.4 The description is given in the form of Message Sequence Diagrams (MSDs) followed by explanatory text.

1.5 The text is referenced from MSDs at appropriate points in the sequences.

1.6 Message contents for successful calls are shown in MSDs. Messages and their contents for alternative sequences (eg for unsuccessful calls) are detailed in the text.

1.7 Coding of the contents of messages is given in SECTION 4.

2 SWAP SUPPLEMENTARY SERVICE WITHIN DPNSS 1

2.1 DEFINITION

The Swap Supplementary Service provides the facilities for converting:

- a call originally set up with a Telephony Service Indicator Code (SIC) as defined in SECTION 6 to a Data Call as defined in SECTION 7.
- a call originally set up with a Data SIC as defined in SECTION 7 to a Telephony Call as defined in SECTION 6.
- a call originally set up with one Data SIC to a call with a different Data SIC.

2.2 DESCRIPTION

A standard call in DPNSS 1 will have been set up with either a Telephony SIC or a Data SIC; these calls are described in SECTIONS 6 and 7, respectively. The SIC and (optionally) the Bearer Service Selection information (SECTION 18) will enable a suitable transmission medium to be selected.

When the calling or called party indicates that a change of service is required, the request is validated at each PBX along its path; if it is acceptable, the change takes place. If any PBX cannot carry out the change, it does not take place.

2.3 OUTLINE OF OPERATION

Paragraphs 2.3.1 and 2.3.2 present examples of Telephony Calls changing to Data Calls. These are not intended to be the only allowable changes but to indicate the general principles of operation such that conversion between any two services should be possible, providing the terminals and the links used are compatible with both services.

2.3.1 TELEPHONY TO X21 DATA TO TELEPHONY

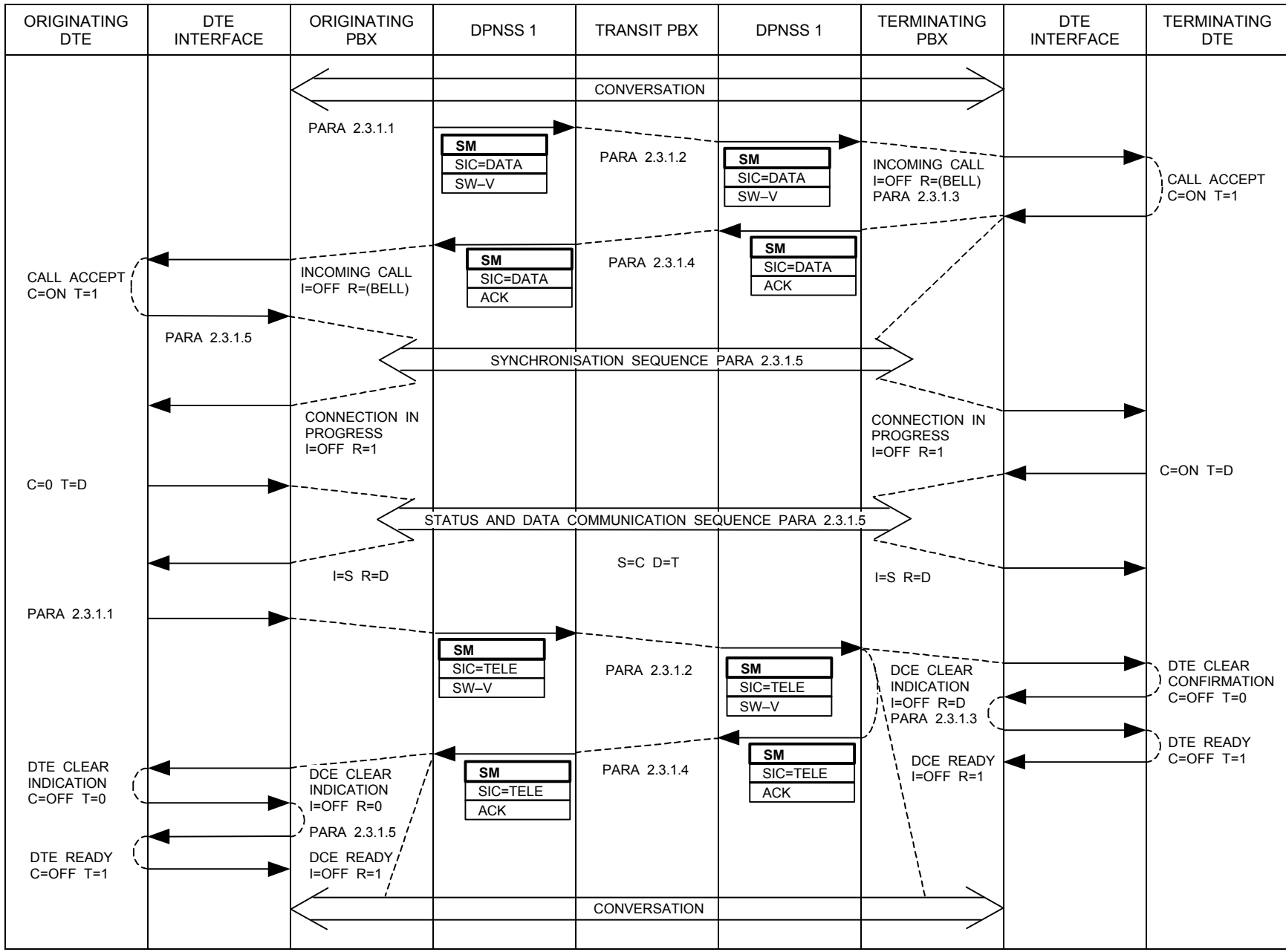

2.3.1.1 Either party in a call which has been answered can initiate a service change. When a request to change the service is received a Swap Message, containing the SIC of the new service and the String Swap Validation (SW-V), is sent to the distant PBX.

Any equipment which will be needed when the new service comes into use shall be reserved before sending the message.

2.3.1.2 On receipt of a Swap Message containing the String SW-V, each Transit PBX shall check that the outgoing DPNSS 1 channel is compatible with the new SIC.

If the new O/G path cannot support the requested service then the call shall be left in the previous state and a Swap Message, containing the String Swap Reject (SW-R) indicating that the path is not available (Parameter = P), shall be sent to the requesting PBX.

If the new service is acceptable then the request is passed on to the next PBX. Any necessary equipment shall be reserved.

If the change cannot be carried out for any other reason (eg no modem available) a Swap Message containing the String SW-R, indicating that the necessary equipment is not available (Parameter = E), is sent to the requesting PBX.

2.3.1.3 On receipt of a Swap Message containing the String SW-V, the End PBX shall check the connected terminal for compatibility with the new SIC.

If the new service is acceptable then the change shall be carried out and a Swap Message, containing the new SIC and the Acknowledgement String (ACK), is sent to the requesting PBX. This may involve changes to the traffic channels involved (eg insertion of pads or connection of modems).

If the new service is unacceptable then the call shall be left in the previous state and a Swap Message with the String SW-R, indicating that the called terminal does not support the service (Parameter = T) shall be sent to the requesting PBX.

If the change cannot be carried out for any other reason (eg. no modem available) a Swap Message, containing the String SW-R, is sent to the requesting PBX to indicate that the necessary equipment is not available (Parameter = E).

2.3.1.4 On receipt of the Swap Message containing the String ACK, Transit PBXs shall carry out the change to the requested service and pass on the Swap Message. This may involve changes to the traffic channels involved (eg insertion of pads or connection of modems).

If a Swap Message is received, containing the String SW-R and the String SNU with Parameter S (indicating that an SIC has not been recognised) or the String SNU with Parameter SW-V (indicating that the Swap request has not been recognised), it shall be passed on and any reserved equipment shall be released.

2.3.1.5 Receipt of a Swap Message containing the String ACK indicates that the change has been successfully carried out by all PBXs involved in the call. The initiating PBX can therefore complete the service change. This may involve changes to the traffic channels involved (eg insertion of pads or connection of modems).

Receipt of a Swap Message containing String SW-R indicates that the change is not possible and an indication shall be given to the user. The reason why it failed is indicated by the Parameter of the String.

PARAMETER	MEANING
P	Call path does not support required service.
T	Other terminal does not support required service.
E	Changeover to the new service cannot be carried out owing to lack of equipment.
I	Changeover not carried out owing to incompatibility between services in force.

Receipt of a Swap Message containing the String SNU with the Parameter S indicates that the SIC requested was not recognised by one of the PBXs involved in the call. Receipt of a Swap Message containing the String SNU with the Parameter SW-V indicates that the Swap Validation was not recognised. The change is not possible and an indication shall be given to the user.

Receipt of a Swap Message containing String SW-V indicates that two requests have passed each other and the received request shall therefore be rejected by sending a Swap Message containing the String SW-R indicating that the request is incompatible (Parameter = I). In this case the outstanding request will also be rejected and the PBX, on receipt of the Swap Message containing the String SW-R, shall indicate to the user that the change has not been carried out.

2.3.2 TELEPHONY TO X21 bis TO TELEPHONY

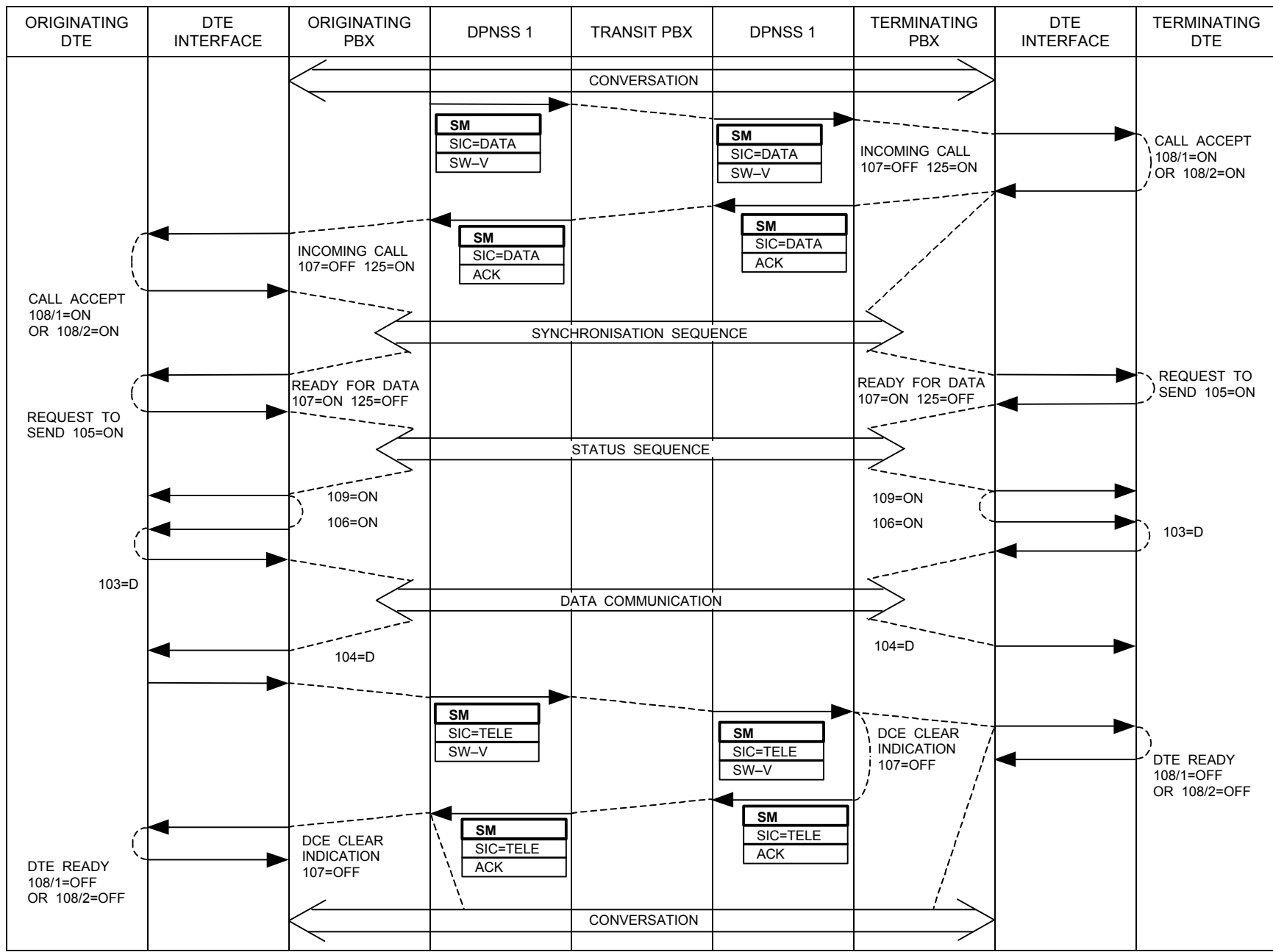

2.3.2.1 This sequence demonstrates how the same signalling procedure can be used to change from the Telephony mode to the Data Communication mode for an X21 bis type of data terminal.

3 COMPLIANCE SHEETS FOR SUPPLEMENTARY SERVICE: SWAP

The Swap Supplementary Service is an optional part of DPNSS 1 and its provision on a PBX is a matter for negotiation between a customer and his supplier (see FOREWORD in SECTION 0 of this specification). This Subsection may be used as an aid to those negotiations.

NOTE: Whilst the provision of this service is optional, if it is provided, compliance with certain features of the service becomes mandatory.

Compliance with the service is considered in terms of the function(s) to be performed by the PBX ie Transit, End or Branching and the extent to which extensions on the PBX can request the service.

The options available are given in TABLE 1. This table should be completed by a manufacturer to indicate PBX capability and by a purchaser to indicate PBX requirements.

TABLES 2 to 4 indicate the features that are required/provided at each PBX. The pre-printed "YES" indicates that the feature is a mandatory part of the service for that PBX function.

TABLE 1

PBX FUNCTION		APPLICABLE TABLE
PBX with extensions, some of which can request the service.		TABLE 2 & 3
PBX with combined Voice/Data terminals none of which can request the service		TABLE 2
Transit PBX		TABLE 4

TABLE 2

COMPLIANCE TABLE FOR A PBX WITH COMBINED VOICE/DATA TERMINALS IN A NETWORK THAT SUPPORTS SWAP		
SERVICE VARIANT		COMMENT
Able to process correctly a Swap Validation Request?	YES	

TABLE 3

ADDITIONAL COMPLIANCE TABLE FOR A PBX WITH EXTENSIONS THAT ARE ABLE TO REQUEST SWAP		
SERVICE VARIANT		COMMENT
Able to request Swap during an established call?	YES	

TABLE 4

COMPLIANCE TABLE FOR A TRANSIT PBX IN A NETWORK THAT SUPPORTS SWAP		
SERVICE VARIANT		COMMENT
Able to co-operate successfully with the Swap Service?	YES	

DIGITAL PRIVATE NETWORK SIGNALLING SYSTEM NO 1 (DPNSS 1)

SECTION 9 - SUPPLEMENTARY SERVICE: CALL BACK WHEN FREE

CONTENTS

1	GENERAL	Page 2
2	CALL BACK WHEN FREE (CBWF) BETWEEN ORDINARY EXTENSIONS WITHIN DPNSS 1	Page 3
2.1	DEFINITION	Page 3
2.2	DESCRIPTION	Page 3
2.3	OUTLINE OF OPERATION	Page 4
2.3.1	Request	Page 6
2.3.2	Free Notification	Page 9
2.3.3	Call Set-Up	Page 12
2.3.4	Cancel Request	Page 16
3	COMPLIANCE	Page 18

HISTORY

Issue 1 - May 1983
Issue 2 - February 1984
Issue 3 - September 1984
Issue 4 - March 1986
Issue 5 - December 1989

Issue 6 - March 2001 - Specification renamed as DPNSS[188]

1 GENERAL

1.1 This Section details the signalling requirements of DPNSS 1 for the Call Back When Free Supplementary Service.

1.2 Subsection 2 details the service within DPNSS 1 and comprises two parts:

- the relationship between the service sequences, and
- specific sequences showing each part of the service in detail.

1.3 Subsection 3 shows the Compliance.

1.4 The description is given in the form of Message Sequence Diagrams (MSDs) followed by explanatory text.

1.5 The text is referenced from MSDs at appropriate points in the sequences.

1.6 Message contents for successful calls are shown in MSDs. Messages and their contents for alternative sequences (eg for unsuccessful calls) are detailed in the text.

1.7 Coding of the contents of messages is given in SECTION 4.

2 CALL BACK WHEN FREE (CBWF) BETWEEN ORDINARY EXTENSIONS WITHIN DPNSS 1

2.1 DEFINITION

Call Back When Free offers a user who meets busy the possibility of having the call completed automatically when the called extension and a transmission path across the network become free.

2.2 DESCRIPTION

An automatic call back may be requested when a user meets busy (called party busy or network congestion) when trying to establish a call within the Private Network. The period following the unsuccessful call attempt during which a Call Back When Free Request (CBWF-R) can be made is dependent upon the design of the Originating PBX. The CBWF-R is registered at the called PBX by means of a Virtual Call; therefore registration should be possible even if network congestion exists. When the called extension becomes free the Originating PBX is notified by means of a Virtual Call. When the requesting party is also free an attempt is made to establish a real connection to the called PBX; if this fails owing to network congestion, repeat attempts are made at regular (configurable) intervals.

After a connection has been established between the two free parties the requesting party is called. When the requesting party answers the wanted extension is called. At this point the Call Back When Free-Request is automatically cancelled from the system and the call awaits answer as for a Simple Call.

In order to minimise network activity some PBXs may block extensions for periods whilst a CBWF call is being processed. For the same reason some PBXs may use the Call Waiting facility to present CBWF calls to busy calling extensions.

If more than one Call Back Request has been registered against the called extension, the Free Notifications shall be handled serially.

The requesting party may cancel a CBWF-Request at any time between the request and the call being established.

If the CBWF call is not established within a given period (suggested value 45 minutes) it is automatically cancelled.

2.3 OUTLINE OF OPERATION

The facility is implemented using four separate but related signalling sequences; these are:

- 2.3.1 Call Back When Free - Request
- 2.3.2 Call Back When Free - Free Notification
- 2.3.3 Call Back When Free - Call Set-Up.
- 2.3.4 Call Back When Free - Cancel Request

The functions of these sequences are as follows:

Call Back When Free - Request. This sequence is used when a calling party requests Call Back When Free to register the request at the Originating and Terminating PBXs.

Call Back When Free - Free Notification. This sequence is used to notify the Originating PBX that the wanted extension is now free.

Call Back When Free - Call Set-Up. This sequence is used to establish the call between the requesting and wanted extensions. This follows receipt of a Free Notification when the extension is, or becomes, free.

Call Back When Free - Cancel Request. This sequence is normally used if a requesting party wishes to cancel a Call Back When Free Request. It is also used when a Call Back When Free Request is cancelled as the result of a timeout.

Figure A shows the relationship of the four Call Back When Free sequences with each other and with normal call sequences; paragraphs 2.3.1 - 2.3.4 detail each sequence showing the message contents.

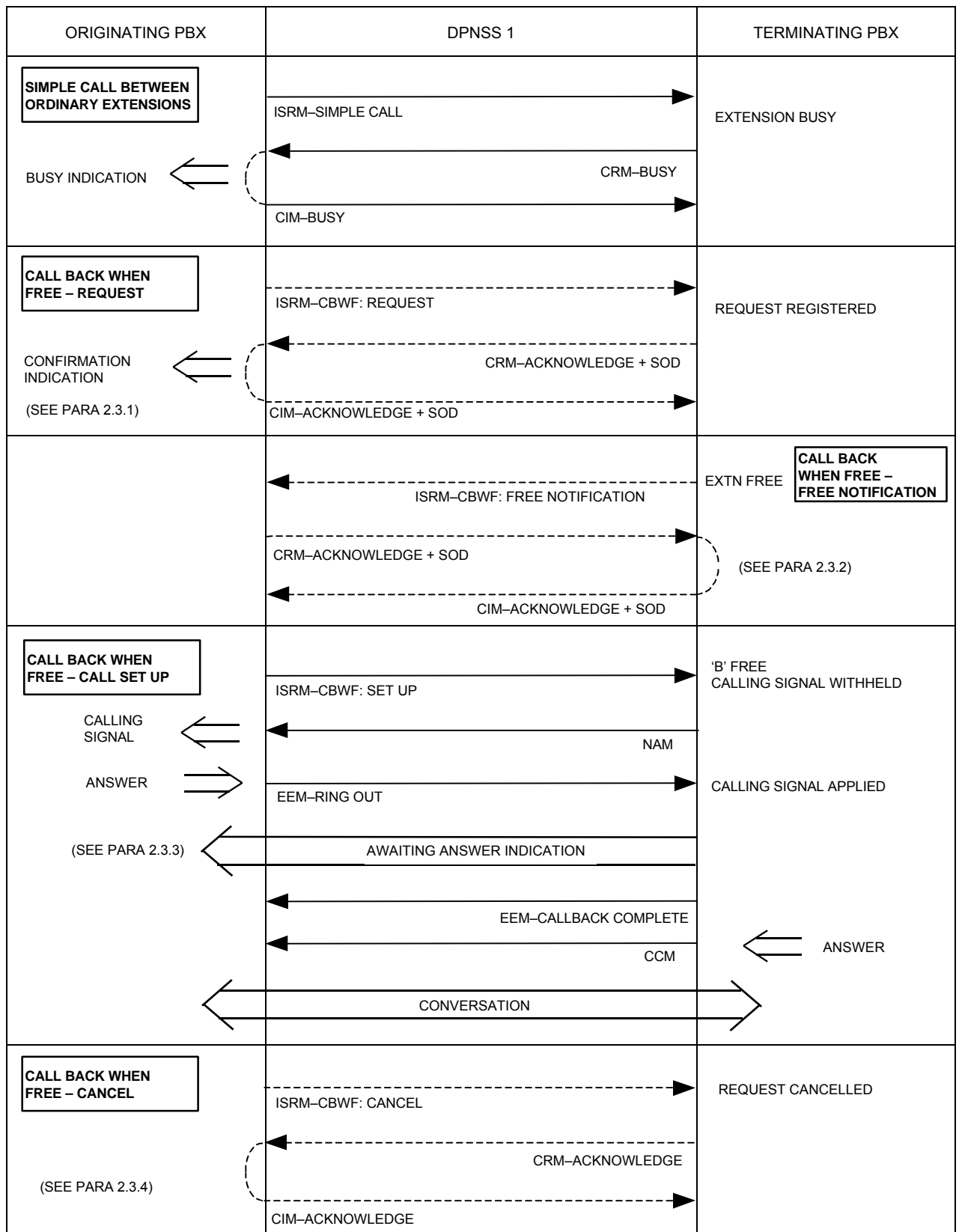
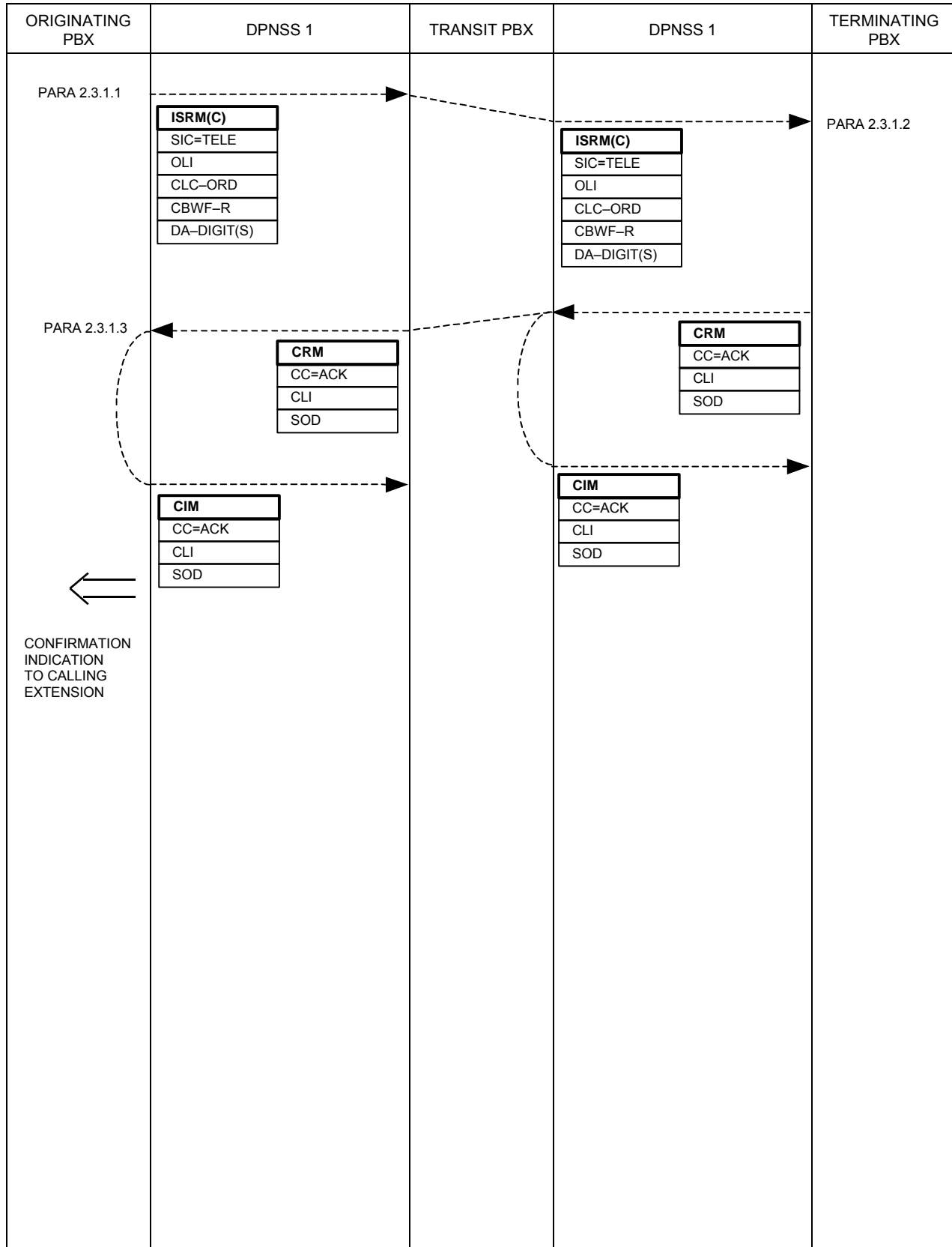

FIGURE A
RELATIONSHIP BETWEEN SEQUENCES FOR CALL BACK WHEN FREE

2.3.1 CALL BACK WHEN FREE-REQUEST



2.3.1.1 A Call Back When Free Request (CBWF-R) normally follows an unsuccessful call attempt. The period following unsuccessful call attempt during which a CBWF request can be made is dependent upon the design of the PBX. The CBWF request shall be validated by the Originating PBX against the requesting extension's class of service and state (eg is the requesting extension allowed CBWF and have the maximum number of requests been registered?, etc).

2.3.1.2 The CBWF Request (sent in a Virtual Call ISRM) shall be validated by the Terminating PBX and if the request is acceptable, the Originating Line Identity shall be stored against the called extension, together with an indication that it is the called extension in a CBWF call.

A CRM containing Clearing Cause: Acknowledge (ACK) and CLI shall be sent to the Originating PBX. If the called extension is busy, String State of Destination Busy (SOD-B) shall be included in the CRM, and the stored request marked as waiting for the called extension to become free. If the called extension is free, String State of Destination Free (SOD-F) shall be included in the CRM and the stored request marked as waiting for Call Set-Up. A CIM shall be expected in response.

A registration timeout of 185 ± 1 minutes shall be started to guard against the request being neither satisfied nor cancelled. If the timeout matures the Terminating PBX shall assume the request to have been cancelled and delete the request from its memory. Note that this timeout should mature only if, owing to a failure condition, cancellation by means of the Call Back When Free Cancel procedure (paragraph 2.3.4) has failed to occur.

If the request is unacceptable a Clear Request Message shall be returned to the Originating PBX with a Clearing Cause as follows:

When the called extension is barred CBWF requests: SU

When the Terminating PBX is temporarily unable to accept further requests (eg queue full): STU

2.3.1.3 On receipt of a CRM at the Originating PBX, the action taken shall be dependent upon the Clearing Cause:

i. Acknowledgement:

The Originating PBX shall store the Called Line Identity against the requesting extension together with an indication that a CBWF is registered. A confirmation indication should be given to the requesting extension and a CIM shall be returned in response to the CRM.

A registration timeout of maximum value 180 minutes (suggested value 45 minutes) shall be started to guard against the request being neither satisfied nor cancelled. If the timeout matures the Originating PBX shall use the Call Back When Free Cancel procedure (paragraph 2.3.4) to cancel the request.

If the State Of Destination (SOD) indicates busy, an indication that the call is waiting for the called extension to become free shall be stored within the PBX.

If the SOD indicates Free then the "Free Notification" sequence given in 2.3.2 shall be omitted and the CBWF Call Set-Up sequence given in 2.3.3 shall be initiated when the requesting extension clears.

ii. Any Other Clearing Cause:

The request shall not be registered and an appropriate rejection indication should be given to the requesting extension; a CIM shall be returned in response to the CRM.

2.3.2 CALL BACK WHEN FREE - FREE NOTIFICATION

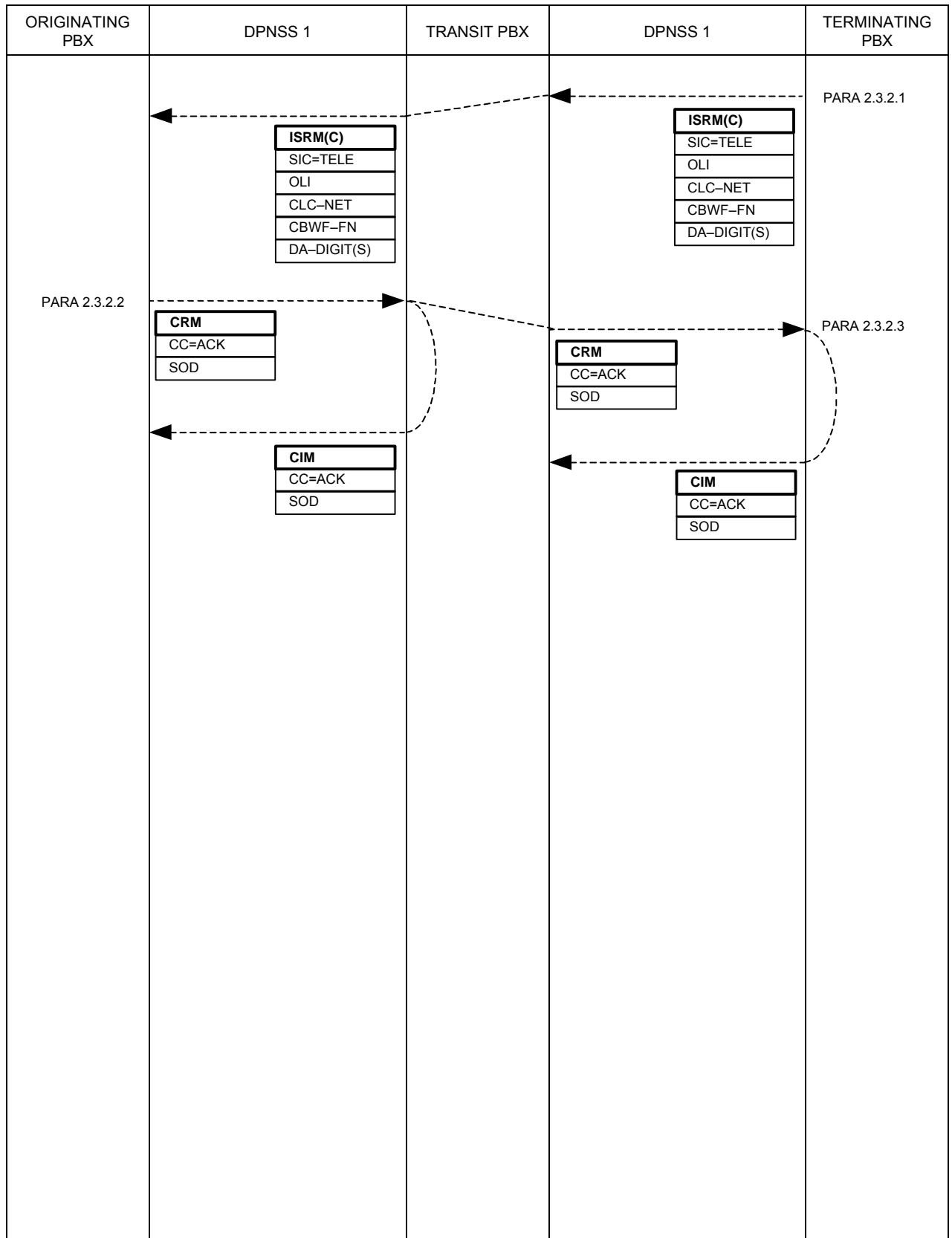

2.3.2.1 When the called extension becomes free a timeout (suggested value 3 s) shall be started. This timeout shall delay the sending of Free Notification in order that the called extension may make a follow on call before the system attempts to deal with the CBWF call which could thus be abortive. If the called extension is still free at the end of the timeout, a Virtual Call shall be established across the network, using as the Destination Address the OLI received with the Call Back When Free-Request, to give notification to the Originating PBX that the called extension is now free (Free Notification).

If more than one Call Back-Request has been registered against the called extension, the Free Notification sequences for that extension shall be handled serially; the order in which they are handled will depend on the design of the PBX to which the called extension is connected.

After the Free Notification has been sent, a timeout shall be started against receiving an acknowledgement. If this timeout expires then the Call-Back shall remain registered, a CRM containing the Clearing Cause: NT shall be sent to clear the Virtual Call and then the same action shall be taken as for receipt of a CRM containing Clearing Cause: Congestion (see paragraph 2.3.2.3).

2.3.2.2 On receipt of the Free Notification the Originating PBX shall check that the CBWF-Request is registered and shall check the state of the requesting extension. It shall then acknowledge the transfer of the control function by clearing the Virtual Call with a CRM containing Clearing Cause: ACK.

If the request is registered and the requesting extension is free the CRM shall also contain the String, "State Of Destination-Free (SOD-F)". The Originating PBX shall then initiate a Call Set-Up attempt (see paragraph 2.3.3).

If the request is registered and the requesting extension is busy the CRM shall also contain the String, "State Of Destination-Busy (SOD-B)". The Call Set-Up attempt shall be delayed until the requesting extension becomes free.

If the request is not registered the CRM shall contain only the Clearing Cause: Facility Not Registered (FNR).

When the Free Notification is received, the Originating PBX shall start a timeout to cover the CBWF Call Set-Up; during this timeout, service shall be withheld from the requesting extension, to give priority to the CBWF Call Set Up.

If the requesting extension is in a state where it cannot take part in a CBWF Call Set-Up (eg out-of-service) the CRM shall contain an appropriate Clearing Cause (see SECTION 4, ANNEX 3). The CBWF records shall be deleted.

2.3.2.3 On receipt of a CRM at the Terminating PBX, the action taken will be dependent upon the Clearing Cause as follows:

i. Acknowledgement

This indicates that control has been transferred to the Originating PBX; the information stored against the called extension shall be updated to indicate that the CBWF call is now waiting for the requesting extension and a CIM is returned to acknowledge the CRM.

If the SOD indicates Busy and the Terminating PBX has blocked the called extension, the blocking shall be removed. The CBWF Registration must be maintained.

If the SOD indicates Busy and the Terminating PBX has other CBWF-Requests registered then the PBX can use the "Free Notification" sequence to notify a further requesting extension that the wanted party is Free.

If the SOD indicates Free the Terminating PBX shall start a timeout to cover non-establishment of the CBWF call.

If this timeout expires and there are other CBWF-Requests registered then the Terminating PBX can use the Free Notification sequence to notify a further requesting extension that the wanted party is free. If the wanted extension has been blocked it should be unblocked.

ii. Congestion

If the called extension has been blocked it shall be unblocked. The PBX shall then repeat the Free Notification sequence either after a timeout occurring whilst the called party is still Free, or on the called party next becoming Free after going Busy.

iii. Any Other Clearing Cause

On receipt of any other Clearing Cause the CBWF records at the Terminating PBX shall be deleted.

2.3.3 CALL BACK WHEN FREE - CALL SET-UP

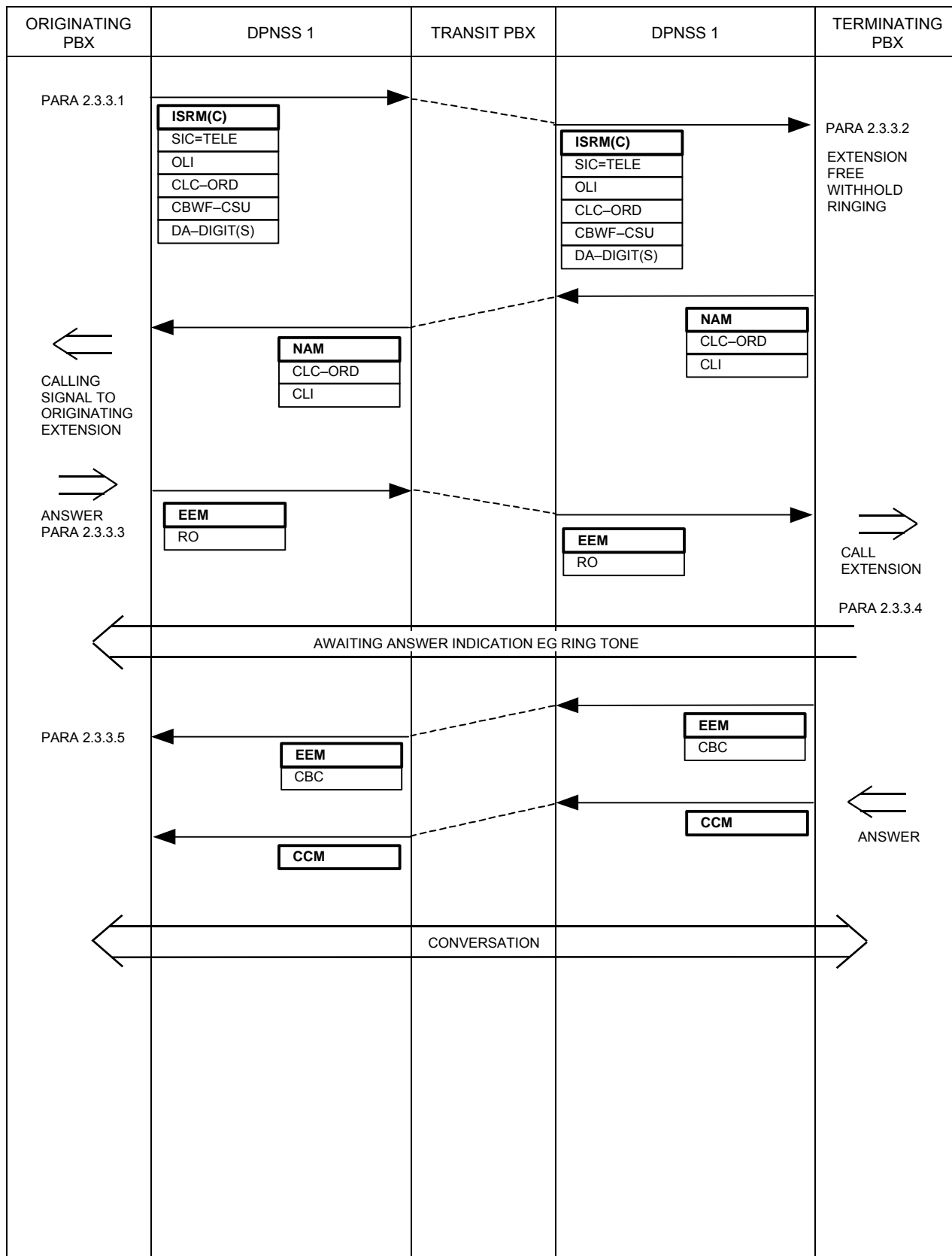

2.3.3.1 This sequence shall be started when:

- i. the Free Notification is received and the requesting extension is Free, or
- ii. the requesting extension becomes Free after receipt of a Free Notification, or
- iii. a timeout has expired in the case of repeat attempts (see paragraph 2.3.3.3), or
- iv. the requesting extension has received a Call Waiting Indication and places the existing call on hold and accepts the waiting call.

The Originating PBX shall send an ISRM containing the SIC, OLI, CLC and CBWF-CSUI or CBWF-CSUD.

CBWF-CSUI shall be used in situation i.

CBWF-CSUD shall be used in situations ii, iii and iv.

These two Strings are treated exactly the same in a fully DPNSS 1 call, but are included to simplify interworking via a Gateway with the evolving Public Network version of the service.

NOTE: In the case where Free Notification consists of the receipt of SOD-F in the CRM sent to acknowledge the CBWF-Request, as described in paragraph 2.3.1.3 (i), either CBWF-CSUI or CBWF-CSUD may be used.

The Destination Address used for the Call Set-Up shall be the CLI received in the CRM containing the acknowledgement to the Call Back When Free-Request (CBWF-R).

2.3.3.2 On receipt of the ISRM and subject to the called extension still being available a NAM containing the CLC and CLI shall be returned to the Originating PBX. The calling signal shall not be applied at this stage. If the called extension has become Busy a Clear Request Message containing a Clearing Cause: Busy shall be returned, and the indication stored against the called extension shall revert to waiting for the called extension to become Free.

NOTE: Because the Call Set-Up sequence uses a different path through the DPNSS 1 network from the Free Notification sequence (using Real Channels instead of Virtual Channels) it is possible for the ISRM of the Call Set-Up sequence to arrive at the Terminating PBX before the CRM of the Free Notification sequence. If this occurs the ISRM shall be acted upon as if a CRM containing the Clearing Cause: ACK had already been received. The Virtual Call shall be cleared by sending a CRM containing the Clearing Cause: NT.

If the called extension is not available for CBWF (eg out-of-service) a CRM containing an appropriate Clearing Cause (see SECTION 4, ANNEX 3) shall be sent and the CBWF records at the Terminating PBX shall be deleted.

2.3.3.3 On receipt of the Number Acknowledge Message and subject to the requesting extension being Free a calling signal shall be applied. If the requesting extension is busy the connection can be released (Clear Request Message with a Clearing Cause: Busy) and the call shall revert to the Waiting for the Requesting Extension State (paragraph 2.3.2.2). Alternatively, Call Waiting may be used to offer the CBWF call to the requesting extension.

On receipt of a Clear Request Message containing Clearing Cause: Busy the call shall be reverted to the Waiting for the Wanted Extension State. If the Clear Request Message contains Clearing Cause: Congestion, repeat attempts to establish a connection shall be performed at intervals defined by a timeout (suggested value 2 minutes) subject to the requesting extension remaining Free. If the requesting extension becomes Busy the repeat attempt shall be stopped and the call reverted to the Waiting for the Requesting Extension State. If the Clear Request Message contains any other Clearing Cause, the CBWF records at the Originating PBX shall be deleted and the CBWF attempt abandoned.

If the requesting party does not answer, or ignores a Call Waiting signal (if used), within a timeout period (8-16 s) the request shall be cancelled at the Originating PBX and the connection shall be cleared by a CRM containing Clearing Cause: Reject, causing the CWBF-Request to be cancelled at the Terminating PBX.

If the requesting party does answer within the timeout period an EEM containing the String "Ring Out (RO)" shall be sent to the Terminating PBX.

2.3.3.4 If the wanted extension is still Free when the Terminating PBX receives the EEM containing the String Ring Out, a calling signal shall be sent to the wanted extension and the Awaiting Answer Indication returned to the requesting party via the speech channel. An EEM containing a Call Back Complete (CBC) String shall then be sent to the Originating PBX. The CBWF-Request shall be deleted from the Terminating PBX records and the call subsequently treated as a Simple Call.

If the wanted extension has become Busy when the Terminating PBX receives the EEM containing the Ring Out String the call shall revert to Awaiting the Wanted Extension State and a Clear Request Message, containing Clearing Cause: Busy, shall be returned to the Originating PBX causing the Busy Indication signal to be given to the requesting extension.

2.3.3.5 On receipt of the EEM containing the Call Back Complete String the CBWF-Request shall be automatically deleted from the Originating PBX records and the call shall be treated thereafter as a Simple Call.

If a Clear Request Message containing Clearing Cause: Busy is received the connection shall be released, the requesting party shall be given Busy Indication, and the call shall revert to the Awaiting the Wanted Extension State.

2.3.4 CALL BACK WHEN FREE - CANCEL REQUEST

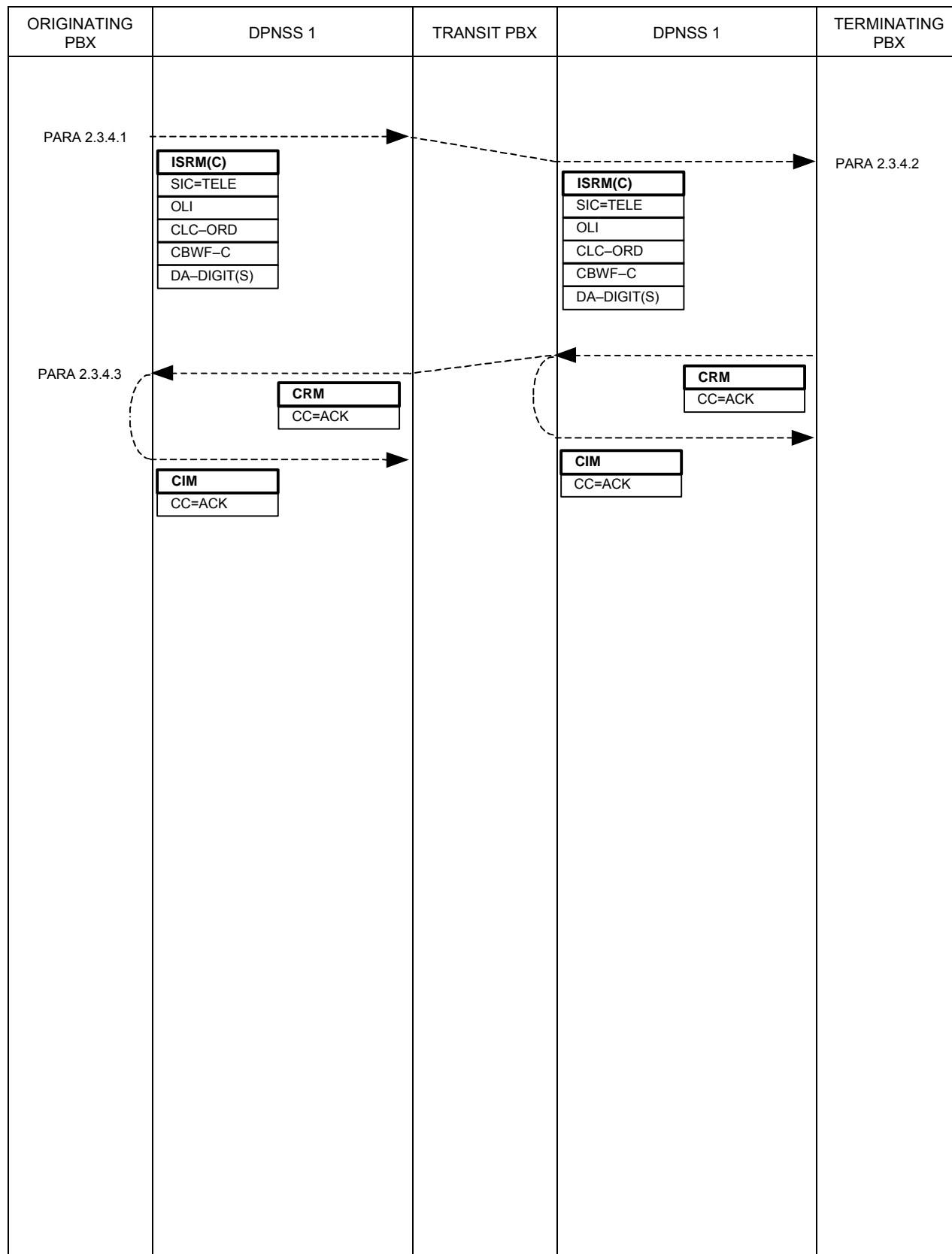

2.3.4.1 The Originating PBX shall validate the Cancel CBWF instruction (ie, shall verify whether there is currently a CBWF-Request registered against the extension).

If the request is valid, a Virtual Call shall be established across the network by means of an ISRM containing the Call Back When Free-Cancel (CBWF-C) String, to notify the Terminating PBX that the CBWF-Request is to be cancelled. The Destination Address used shall be the CLI received in the CRM containing the acknowledgement to the Call Back When Free-Request (CBWF-R). The Originating PBX shall delete the request from its records and should give a confirmation indication to the user.

If the request is invalid an indication should be given to the requesting extension.

This procedure may also be initiated automatically by the Originating PBX if the timeout started at the time the request was registered expires.

2.3.4.2 On receipt of an ISRM containing the CBWF-Cancel String the Terminating PBX shall validate the request. If the cancellation request is valid it shall delete the CBWF-Request from its records and send a Clear Request Message containing Clearing Cause: Acknowledgement (ACK) to the Originating PBX. However, if the called extension does not currently have a CBWF-Request registered, then a Clear Request Message containing Clearing Cause: "Facility Not Registered" (FNR) shall be returned.

2.3.4.3 Receipt of a CRM containing any Clearing Cause is acceptable. It may be an internal function of the PBX to give some indication if a Clearing Cause other than ACK is received.

3 COMPLIANCE SHEETS FOR SUPPLEMENTARY SERVICE: CALL BACK WHEN FREE

The Call Back When Free Supplementary Service is an optional part of DPNSS 1 and its provision on a PBX is a matter for negotiation between a customer and his supplier (see FOREWORD in SECTION 0 of this specification). This Subsection may be used as an aid to those negotiations.

NOTE: Whilst the provision of this service is optional, if it is provided, compliance with certain features of the service becomes mandatory.

Compliance with the service is considered in terms of the function(s) to be performed by the PBX ie Transit, End or Branching and the extent to which extensions on the PBX can request the service.

The options available are given in TABLE 1. This table should be completed by a manufacturer to indicate PBX capability and by a purchaser to indicate PBX requirements.

TABLES 2 to 4 indicate the features that are required/provided at each PBX. The pre-printed "YES" indicates that the feature is a mandatory part of the service for that PBX function.

TABLE 1

PBX FUNCTION		APPLICABLE TABLE
PBX with operators or extensions, some of which can request the service.		TABLES 2 & 3
PBX with operators or extensions, none of which can request the service.		TABLE 2
Transit PBX		TABLE 4

TABLE 2

COMPLIANCE TABLE FOR A PBX WITH OPERATORS OR EXTENSIONS IN A NETWORK THAT SUPPORTS CALL BACK WHEN FREE		
SERVICE VARIANT		COMMENT
Able to accept a Call Back When Free - Request from another DPNSS 1 PBX?	YES	
Able to notify another DPNSS 1 PBX that the required extension is now free?	YES	
Able to accept a Call Back When Free - Call Set-Up from another DPNSS 1 PBX?	YES	
Able to accept a Call Back When Free - Cancellation from another DPNSS 1 PBX?	YES	

TABLE 3

ADDITIONAL COMPLIANCE TABLE FOR PBXs WITH OPERATORS OR EXTENSIONS THAT ARE ABLE TO REQUEST CALL BACK WHEN FREE		
SERVICE VARIANT		COMMENT
Able to request Call Back When Free to another DPNSS 1 PBX?	YES	
Able to make a Call Back When Free Call following notification that the required extension is free?	YES	
Able to send a Call Back When Free Cancellation to another DPNSS 1 PBX	YES	

TABLE 4

COMPLIANCE TABLE FOR A TRANSIT PBX IN A NETWORK THAT SUPPORTS CALL BACK WHEN FREE		
SERVICE VARIANT		COMMENT
Able to act as a Transit for: -Call Back When Free-Request (Virtual Call) -Free Notification (Virtual Call) -Cancellation (Virtual Call) -Call Back When Free-Call Set-Up (Real Call)	YES	Inherent DPNSS 1 capability

DIGITAL PRIVATE NETWORK SIGNALLING SYSTEM NO 1 (DPNSS 1)

SECTION 10 - SUPPLEMENTARY SERVICE: EXECUTIVE INTRUSION

CONTENTS

1	GENERAL	Page 2
2	EXECUTIVE INTRUSION BETWEEN ORDINARY EXTENSIONS WITHIN DPNSS 1	Page 3
2.1	DEFINITION.....	Page 3
2.2	DESCRIPTION.....	Page 3
2.2.1	Intrusion Capability and Protection Levels.....	Page 3
2.2.2	Without Prior Validation.....	Page 4
2.2.3	With Prior Validation.....	Page 5
2.2.4	Withdrawal from Intrusion.....	Page 5
2.3	OUTLINE OF OPERATION.....	Page 5
2.3.1	Executive Intrusion - Without Prior Validation	Page 6
2.3.2	Executive Intrusion - With Prior Validation	Page 11
2.3.3	Withdrawal from Intrusion.....	Page 15
3	COMPLIANCE	Page 17

HISTORY

Issue 1 - May 1983
Issue 2 - February 1984
Issue 3 - September 1984
Issue 4 - March 1986
Issue 5 - December 1989

Issue 6 - March 2001 - Specification renamed as DPNSS[188]

1 GENERAL

- 1.1** This Section details the signalling requirements of DPNSS 1 for the Executive Intrusion Supplementary Service.
- 1.2** Subsection 2 details the service within DPNSS 1.
- 1.3** Subsection 3 shows the Compliance.
- 1.4** The description is given in the form of Message Sequence Diagrams (MSDs) followed by explanatory text.
- 1.5** The text is referenced from MSDs at appropriate points in the sequences.
- 1.6** Message contents for successful calls are shown in MSDs. Messages and their contents for alternative sequences (eg. for unsuccessful calls) are detailed in the text.
- 1.7** Coding of the contents of message is given in SECTION 4.

2 EXECUTIVE INTRUSION (BETWEEN ORDINARY EXTENSIONS) WITHIN DPNSS 1

2.1 DEFINITION

Executive Intrusion offers users of selected extensions, who meet busy, the possibility of intruding on the established conversation. As an option the intruding party may withdraw from the intrusion without clearing down.

2.2 DESCRIPTION

An Executive Intrusion call may be requested when a user meets called extension busy when trying to establish a call.

Three activities are specified within the Executive Intrusion Service:-

- i. Executive Intrusion - Without Prior Validation
- ii. Executive Intrusion - With Prior Validation
- iii. Withdrawal from Intrusion

2.2.1 Intrusion Capability and Protection Levels

In order to control the use of Executive Intrusion the signalling system allows for each extension to have an Intrusion Capability Level (ICL) and an Intrusion Protection Level (IPL).

The following levels are used:

ICL	IPL
Intrusion Level 3	Total Protection
Intrusion Level 2	Protection Level 2
Intrusion Level 1	Protection Level 1
No intrusion	Protection Level 0

Intrusion will be allowed only where the ICL of the intruding extension is greater than the IPLs of both the wanted and the unwanted extensions on the established call, and where the call is not otherwise non-intrudable. The IPL of a party may be artificially raised, by virtue of his state, to prevent intrusion (eg when intrusion is already taking place). In particular, a party engaged on an incompletely established call shall be assigned an IPL of 3.

The following diagram illustrates which ICLs are allowed to intrude upon which IPLs for two PBXs supporting the full intrusion service. An arrow indicates that intrusion is allowed.

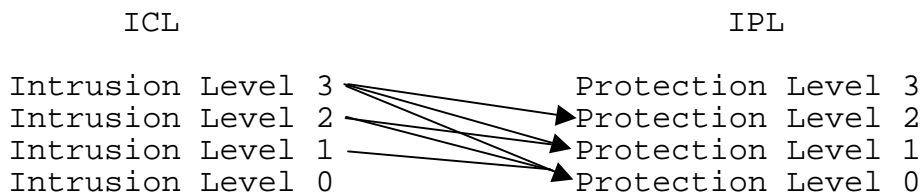

The way in which extensions are assigned ICLs and IPLs is PBX-dependent. For example, extensions may be assigned individual ICLs and IPLs. Alternatively, classes of extensions may be assigned values. In addition, users may be given some degree of dynamic control to override the default values assigned to them.

Example :-

A system may offer Executive Intrusion in the following manner:

- Each extension is allowed or not allowed to intrude by a single-bit Class of Service (COS) indicator within the PBX.
- All extensions can be intruded upon - subject to type and state of call.

In the above case, the COS of the extension can be mapped on to the signalling levels in the following way:

Executive Intrusion allowed = Intrusion Level 2
All extensions = Protection Level 0

Where:

- Intrusion Level 2 represents the middle of the range of levels, allowing interworking to take place with extensions of higher, lower or equal status.
- Protection Level 0 satisfies the requirement that all extensions can be intruded upon.

By using these levels it is possible to interwork systems so that some or all of the extensions may intrude upon each other.

2.2.2 Executive Intrusion - without Prior Validation

Executive Intrusion without Prior Validation is a Supplementary Service that can be used from selected extensions following an unsuccessful call. The facility assumes that the connection associated with the unsuccessful call has been released and that Busy Indication is supplied locally from the Originating PBX.

An Executive Intrusion Request, therefore, causes a new connection to be established between the PBXs of the intruding and the wanted extensions. Following establishment of the new connection the request is validated against, the IPLs of the wanted and unwanted extensions, and the type and state of the established call. Subject to the request being acceptable an Intrusion Indication is superimposed on the established call and is also returned to the intruding extension. This indicates to all three users that intrusion is going to take place and then the three extensions are connected in a three-way conversation. A warning indication (audible to all users) is then inserted into the call.

2.2.3 Executive Intrusion - with Prior Validation

Executive Intrusion with Prior Validation is a Supplementary Service which, if registered on an extension, is used on every Simple Call Request. The facility causes the same validation procedure that is used by Executive Intrusion without Prior Validation to be performed, at normal call set up time, if the wanted extension is busy. The facility also maintains the connection to the wanted extension, whilst a Busy Intrudable Indication is given to the calling party. If the calling party then requests Executive Intrusion it has a very high probability of success. If the wanted extension is busy and unintrudable then a Busy Unintrudable Indication is given which eliminates most abortive intrusion attempts. This version of Executive Intrusion minimises time in attempting to intrude on unintrudable calls and improves the probability of a successful intrusion.

2.2.4 Withdrawal from Intrusion

Withdrawal from Intrusion is an optional facility which, if provided, allows the intruding party to end the intrusion by withdrawing from the three-party connection without clearing. The intruder is then left in the Busy Intrudable State (see 2.2.3 above) and can re-intrude or clear at any time.

2.3 OUTLINE OF OPERATION

The Executive Intrusion Service is specified by the following signalling sequences:

- 2.3.1 Executive Intrusion - without Prior Validation
- 2.3.2 Executive Intrusion - with Prior Validation
- 2.3.3 Withdrawal from Intrusion

2.3.1 EXECUTIVE INTRUSION WITHOUT PRIOR VALIDATION

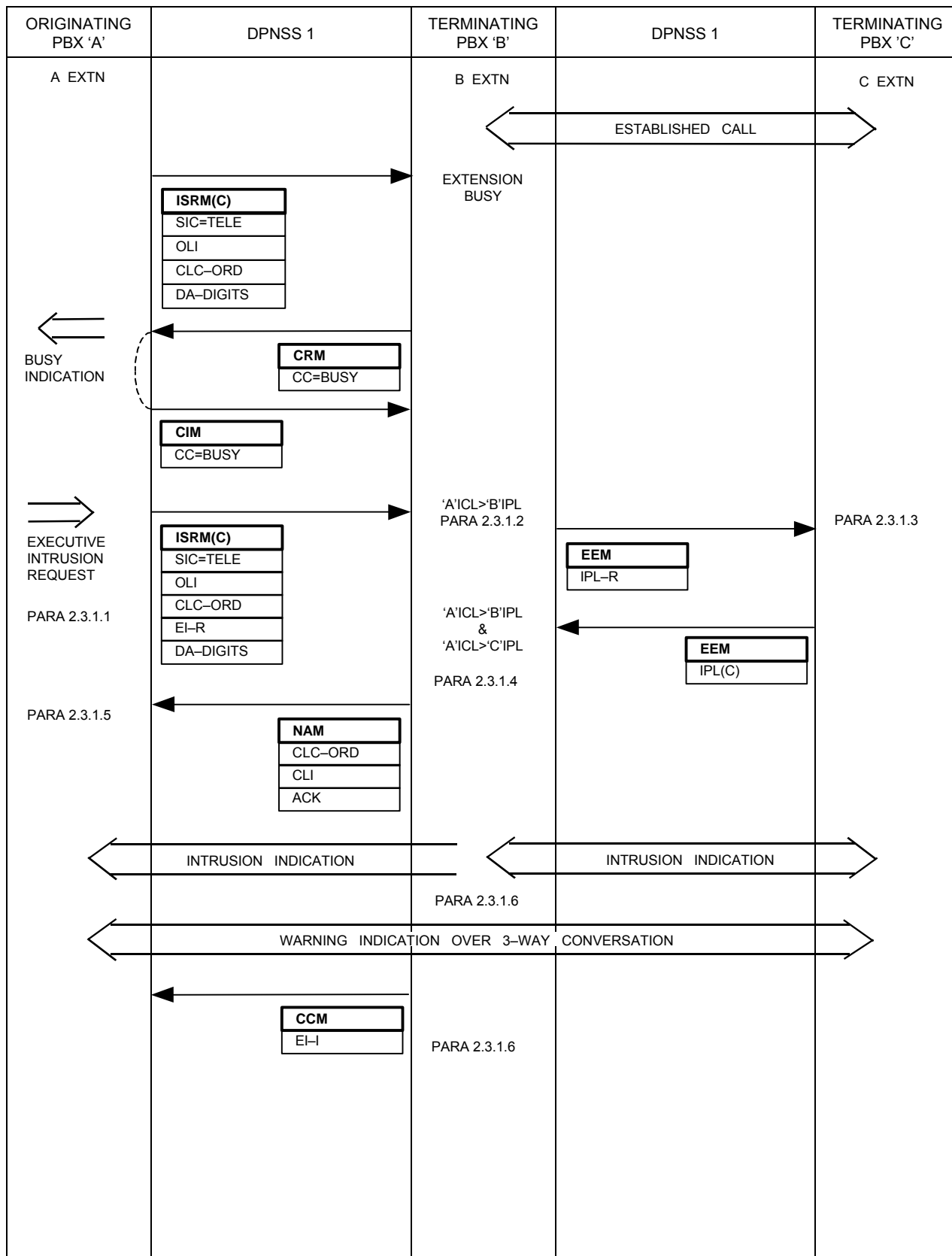

2.3.1.1 An Executive Intrusion Request will normally follow an unsuccessful call attempt. The period following an unsuccessful call attempt, during which an Executive Intrusion call can be made, is dependent upon the design of the PBX (ie It may be restricted to the period whilst the originating user remains off hook and is receiving Busy Indication. However, it may also be possible to make the request, even after clearing, if the last number dialled is stored).

Subject to the originating extension having the Executive Intrusion capability an ISRM shall be used to establish a connection to the wanted extension. The essential difference between this and a Simple Call ISRM is that the Selection Field will contain an Executive Intrusion Request (EI-R). The Parameter of EI-R is the intruding extension's Intrusion Capability Level (ICL).

2.3.1.2 If the wanted extension is still busy the request shall be validated against the wanted extension's COS, call state, etc [ie whether the intruding extension's ICL is higher than the wanted extension's Intrusion Protection Level (IPL)].

If the request is acceptable the IPL of the unwanted party shall be requested by sending an EEM, containing the String "Intrusion Protection Level Request (IPL-R)" to the unwanted party's PBX on the established call's signalling channel.

If the request is unacceptable it shall be rejected by the use of a CRM containing Clearing Cause: BY.

If the wanted extension has become free, it shall be called, the Awaiting Answer Indication shall be returned in the traffic channel and a Number Acknowledge Message (NAM), containing CLC and CLI, shall be returned to the Originating PBX. After this the call shall be treated as a Simple Call.

2.3.1.3 In response to the EEM, containing the IPL-R String, the PBX associated with the unwanted extension shall return the extension's IPL in an EEM.

The extension's IPL may be raised due to the state of the call eg Three-Party.

2.3.1.4 The intruding extension's ICL shall be compared with the unwanted extension's IPL. If the response to IPL-R is SNU instead of IPL, a value for the IPL shall be assumed. This may be a default value (such as 3 - to prevent intrusion) or it may be derived from the known details of the other party (eg CLC).

If the intruding extension's ICL is higher than the unwanted extension's IPL and the wanted extension is still intrudable, a NAM containing CLC, CLI and ACK shall be returned to the Originating PBX (this indicates that Executive Intrusion is about to take place).

According to the design of the PBX, there may be a delay before intrusion actually takes place; however, on some PBXs intrusion may take place immediately. If the PBX introduces a delay, the Intrusion Indication shall be superimposed on the established call and separately returned to the Intruding party via the traffic channel (this indicates to all the users that intrusion is going to take place).

If the intruding extension's ICL is not higher than the unwanted extension's IPL or the wanted extension has become unintrudable then the request shall be rejected by use of a Clear Request Message containing Clearing Cause: Busy.

If the wanted extension has become free it shall be called, the Awaiting Answer Indication returned in the traffic channel, and a NAM containing CLC and CLI returned to the Originating PBX, after which the call shall be treated as a Simple Call.

If the unwanted extension has cleared, such that a CRM is received instead of a EEM containing IPL, the situation shall be treated as if an EEM containing an IPL with Parameter 0 had been received before the CRM. That is, a NAM containing CLC, CLI and ACK shall be returned and the call shall be presented to the wanted extension in the same manner as if the unwanted extension had cleared during intrusion indication (see 2.3.1.6).

2.3.1.5 Receipt of a NAM containing the String Acknowledge (ACK) indicates that the intrusion request has been accepted.

If a CRM is received containing the Clearing Cause: Busy, this indicates that intrusion is not allowed on the call. Receipt of a CRM with any other Clearing Cause indicates that the intrusion request has failed. In either case, the Originating PBX shall give an indication to the intruding user.

2.3.1.6 After the application of the Intrusion Indication the intrusion shall take place. This involves connecting the speech paths for all three extensions in a three-way conference mode together with the Warning Indication. A Call Connected Message (CCM) containing EI-I shall be sent to the Originating PBX.

If the intruding extension clears before the intrusion takes place the established call shall revert to its previous state. This merely requires an exchange of clear messages on the intruding channel.

If the wanted extension clears before the intrusion takes place, the established call shall be released, the wanted extension called, the Awaiting Answer Indication returned in the traffic channel, and an EEM containing SOD Free (SOD-F) returned to the Originating PBX, after which the call shall be treated as a Simple Call.

If the unwanted extension clears during this time period the established call shall be released and the intrusion call presented to the wanted extension. Under these conditions merely making a connection between the intruding and wanted extensions may lead to confusion or embarrassment for the wanted user as the intrusion signal may not have been noticed so close to clear-down (ie the clear may have been coincidental). How the call is presented to the wanted extension depends on the PBX and extension design. If the wanted party is forced to go on-hook to accept the call, then the call shall proceed as normal for the wanted party clearing before the intrusion takes place. If the wanted party is not forced to clear, then, on connection of the wanted extension to the traffic channel, a CCM containing EI-I shall be sent, followed immediately by an EEM containing TWP, and Warning Indication shall not be applied.

2.3.1.7 The call should remain in this three-way conversation mode, with the Warning Indication superimposed, until one of the users clears, or the intruder withdraws.

If the intruding extension clears, the original call shall revert to its previous state.

If the wanted extension clears, the original call shall be released. If the wanted extension is then to be re-rung, the Awaiting Answer Indication shall be returned in the traffic channel, and an EEM containing SOD-F returned to the Originating PBX, after which the call shall be treated as a Simple Call. If the wanted extension is not to be re-rung, the intruding call shall be released by sending a CRM containing Clearing Cause: Call Termination (CT).

If the unwanted extension clears, the original call shall be released. If the remaining call between the intruder and the wanted party is to be converted to a Simple Call, Warning Indication shall be removed and an EEM containing TWP sent to the intruding party's PBX. If the remaining call is not to be converted to a Simple Call, the intruding call shall be released by sending a CRM containing Clearing Cause: Call Termination (CT).

When intrusion is initiated, there is the possibility that, on detection of the intrusion, the unwanted party may clear in order to drop-out and the wanted party may clear in order to be rung back. In the case where clearing of the unwanted party leads to a Simple Call, there is a possibility that the unwanted party's clearing will be detected first, causing conversion of the remaining call to a Simple Call, and that this will then be cleared on detection of the wanted party's clearing.

In order to cater for this case, a timer (suggested value 5 s) may be started at the wanted party's PBX when the unwanted party clears. If the wanted party clears before expiry of this timer, the wanted extension shall be called, Awaiting Answer Indication shall be applied to the traffic channel and an EEM containing SOD-F returned to the Originating PBX. The call shall then proceed as a Simple Call.

NOTE: Where National regulations require a delay before Intrusion takes place, then compliance to that requirement shall be provided by the PBX.

CEPT recommends a delay of 2 s before intrusion takes place.

2.3.2 EXECUTIVE INTRUSION WITH PRIOR VALIDATION

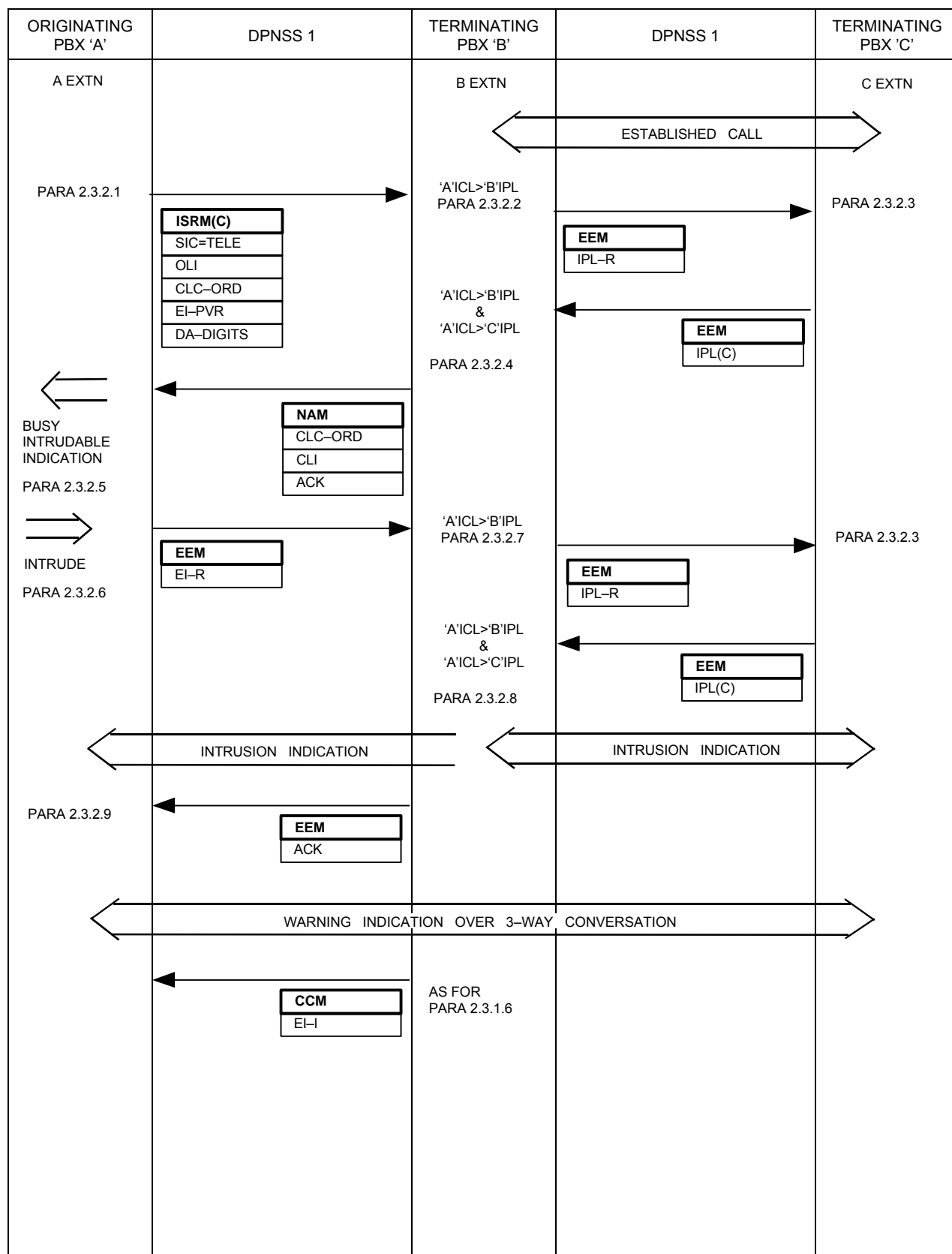

2.3.2.1 All call requests, from extensions with a COS indicating Executive Intrusion with Prior Validation capability, shall use an ISRM which contains Supplementary Information String, "Executive Intrusion Prior Validation-Request (EI-PVR)", with the Intrusion Capability Level (ICL) of the originating extension as a Parameter.

2.3.2.2 If the wanted extension is busy the request shall be validated against the wanted extension's COS, call state, etc [ie whether the originating extension's ICL is higher than the wanted extension's Intrusion Protection Level (IPL)].

If the wanted extension is busy and intrudable the IPL of the unwanted extension shall be requested using an EEM containing the Intrusion Protection Level Request (IPL-R) String on the signalling channel of the established call.

If the wanted extension is busy and unintrudable the request shall be rejected by means of a Clear Request Message, containing Clearing Cause: Busy.

If the wanted extension is free it shall be called, the Awaiting Answer Indication returned in the traffic channel and a NAM containing CLI and CLC returned to the Originating PBX, after which the call shall be treated as a Simple Call. This also applies if the wanted extension becomes free before receipt of the EEM containing the IPL of the unwanted extension. The NAM shall not contain an acknowledgement to EI-PVR.

2.3.2.3 In response to the EEM containing the IPL-R String, the PBX associated with the unwanted extension shall return the extension's IPL in an EEM. The extension's IPL may be raised due to the state of the call.

2.3.2.4 The originating extension's ICL is compared with the unwanted extension's IPL. If the response to IPL-R is SNU, instead of IPL, a value for the IPL must be assumed. This may be a default value (such as 3 - to prevent intrusion) or it may be derived from the known details of the other party (eg CLC).

If the originating extension's ICL is higher than the unwanted extension's IPL and the wanted extension is still intrudable a NAM containing CLC, CLI and ACK shall be sent to the Originating PBX.

If the originating extension's ICL is not higher than the unwanted extension's IPL or the wanted extension has become unintrudable then the request shall be rejected by use of a Clear Request Message, containing Clearing Cause: Busy.

If the unwanted extension has cleared, such that a CRM is received instead of a EEM containing IPL, the situation shall be treated as if an EEM containing an IPL with Parameter 0 had been received before the CRM. That is, a NAM containing CLC, CLI and ACK shall be returned.

2.3.2.5 On receipt of the NAM containing the ACK String Busy Intrudable Indication shall be given to the originating user. As a connection is being held during this period a short timeout (eg 10 s) shall be started. On expiry of this timeout if intrusion has not been requested the connection shall be released.

2.3.2.6 On receipt of an intrusion request an EEM containing the Executive Intrusion-Request (EI-R) String shall be sent to the wanted party's PBX.

2.3.2.7 On receipt of the EEM containing the EI-R String when the wanted extension is still busy and intrudable, the IPL of the unwanted extension shall be requested using the sequence described in paragraphs 2.3.2.2 to 2.3.2.4.

If the wanted extension has become free it should be called, the Awaiting Answer Indication returned in the traffic channel and an EEM containing SOD-F returned to the Originating PBX, after which the call shall be treated as a Simple Call.

If the wanted extension has become unintrudable (eg the unwanted party may have cleared and the wanted party may still be off-hook and listening to dial tone) the intrusion request shall be rejected by returning to the Originating PBX a Clear Request Message containing Clearing Cause: Busy.

2.3.2.8 On receipt of the unwanted extension's IPL and, subject to the intruding extension's ICL being greater than the wanted and unwanted extensions' IPLs, the Intrusion Indication shall be superimposed on the established call and separately returned to the intruding user via the traffic channel. At the same time an EEM containing ACK shall be returned to the Originating PBX.

According to the design of the PBX there may be a delay before Intrusion actually takes place (see paragraph 2.3.1.4). From this point onwards the call shall be treated as a Without Prior Validation intruding call (see paragraphs 2.3.1.6 and 2.3.1.7).

If the call has become unintrudable the intrusion request shall be rejected by returning a Clear Request Message containing Clearing Cause: Busy to the Originating PBX.

If the wanted extension becomes free, before receipt of the EEM containing the unwanted extension's IPL, the extension shall be called, the Awaiting Answer Indication returned in the traffic channel and an EEM containing SOD-F returned to the Originating PBX, after which the call shall be treated as a Simple Call.

If the unwanted extension has cleared, such that a CRM is received instead of a EEM containing IPL, the situation shall be treated as if an EEM containing an IPL with Parameter 0 had been received before the CRM. That is, Intrusion Indication shall be returned to the requesting party on the traffic channel; an EEM containing ACK shall be sent to the Originating PBX, and the call shall be presented to the wanted extension in the same manner as if the unwanted extension had cleared during Intrusion Indication (see 2.3.1.6).

2.3.2.9 Receipt of an EEM containing ACK indicates that the intrusion request has been accepted. From this point onwards the call is treated identically to a Without Prior Validation intruding call.

Receipt of a CRM containing Clearing Cause: Busy indicates that intrusion is not possible; Busy Indication shall be given to the intruding user and a CIM returned in response.

2.3.3 WITHDRAWAL FROM INTRUSION

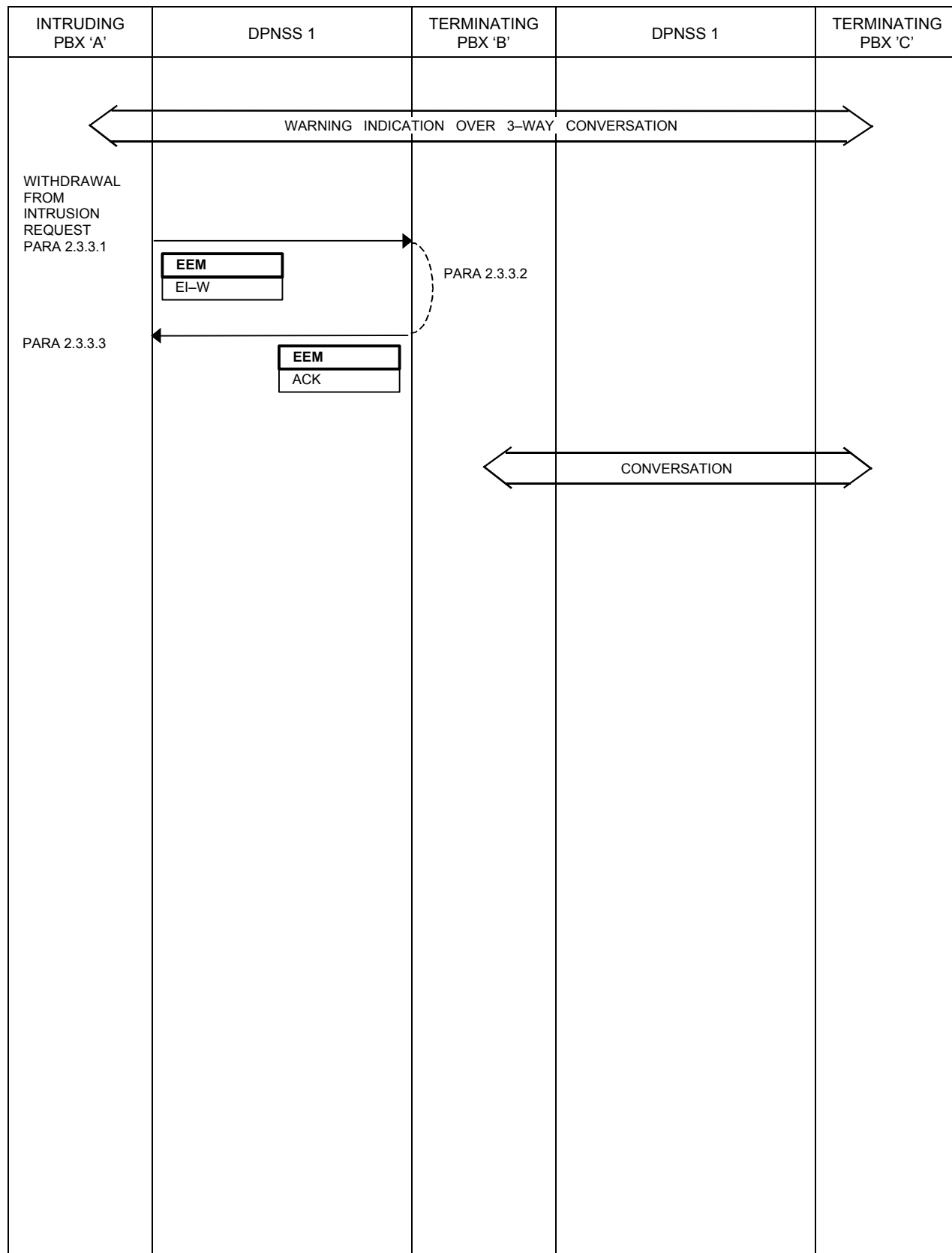

2.3.3.1 When the intruding party requests Withdrawal from Intrusion an End to End Message, containing Executive Intrude Withdraw (EI-W) shall be sent to the wanted party's PBX.

2.3.3.2 On receipt of the EEM containing EI-W the wanted party's PBX shall remove the warning indication, disconnect the traffic channel to the Intruding PBX, re-establish the connection between the wanted and unwanted parties, and send an EEM containing ACK to the Intruding PBX.

If Withdrawal from Intrusion is not supported, EI-W will be treated as an unrecognised String and an EEM containing SNU will be returned to the Intruding PBX, in accordance with general signalling procedures (see SECTION 5).

If the unwanted party has cleared, causing conversion of the remaining call to a Simple Call, or the wanted party has cleared and is being rerung, EI-W shall be ignored.

2.3.3.3 On receipt of an EEM containing ACK the Intruding PBX shall return to the Wait Intrusion-Request State and may give an appropriate indication to its party.

If the Intruding PBX receives an EEM containing SNU the call shall remain in the Intrusion Completed State.

If the Intruding PBX receives an EEM containing TWP or SOD-F, this indicates that the call has been converted to a Simple Call and that EI-W has been ignored by the wanted party's PBX.

3 COMPLIANCE SHEET FOR SUPPLEMENTARY SERVICE: EXECUTIVE INTRUSION

The Executive Intrusion Supplementary Service is an optional part of DPNSS 1 and its provision on a PBX is a matter for negotiation between a customer and his supplier (see FOREWORD in SECTION 0 of this specification). This Subsection may be used as an aid to those negotiations.

NOTE: Whilst the provision of this service is optional, if it is provided, compliance with certain features of the service becomes mandatory.

Compliance with the service is considered in terms of the function(s) to be performed by the PBX, ie Transit, End or Branching, and the extent to which extensions on the PBX can request the service.

The options available are given in TABLE 1. This table should be completed by a manufacturer to indicate PBX capability and by a purchaser to indicate PBX requirements.

TABLES 2 to 4 indicate the features that are required/provided at each PBX. The pre-printed "YES" indicates that the feature is a mandatory part of the service for that PBX function.

TABLE 1

PBX FUNCTION		APPLICABLE TABLE
PBX with operators or extensions, some of which can request the service.		TABLES 2 & 3
PBX with operators or extensions none of which can request the service.		TABLE 2
Transit PBX		TABLE 4

TABLE 2

COMPLIANCE TABLE FOR A PBX WITH OPERATORS OR EXTENSIONS IN A NETWORK THAT SUPPORTS EXECUTIVE INTRUSION		
SERVICE VARIANT		COMMENT
Able to accept an Executive Intrusion Without Prior Validation call?	YES	
Able to accept an Executive Intrusion with Prior Validation call?		
Able to respond correctly to an Intrusion Protection Level Request?	YES	
Able to send an Intrusion Protection level Request?	YES	
Able to apply a delay before intrusion takes place?		State time
Able to re-ring the wanted party if it hangs up during intrusion?		
Default Intrusion Protection Level assumed if Signal Not Understood is indicated in response to Intrusion Protection Level Request?	YES	State how default IPL is assigned
Able to accept a Withdrawal from Intrusion Request?		

TABLE 3

ADDITIONAL COMPLIANCE TABLE FOR A PBX WITH OPERATORS OR EXTENSIONS THAT ARE ABLE TO REQUEST EXECUTIVE INTRUSION		
SERVICE VARIANT		COMMENT
Able to request Executive Intrusion without Prior Validation?		
Able to request Executive Intrusion with Prior Validation?		
Able to request Withdrawal from Intrusion?		

TABLE 4

COMPLIANCE TABLE FOR A TRANSIT PBX THAT SUPPORTS EXECUTIVE INTRUSION		
SERVICE VARIANT		COMMENT
Able to act as a Transit for the Executive Intrusion Supplementary Service?	YES	Inherent DPNSS 1 Capability

DIGITAL PRIVATE NETWORK SIGNALLING SYSTEM NO 1 (DPNSS 1)

SECTION 11 - SUPPLEMENTARY SERVICE: DIVERSION

CONTENTS

1	GENERAL	Page 3
2	CALL DIVERSION WITHIN DPNSS 1	Page 4
2.1	DEFINITION.....	Page 4
2.2	DESCRIPTION.....	Page 4
2.3	OUTLINE OF OPERATION.....	Page 6
2.3.1	Registration from the Controlling Extension.....	Page 7
2.3.2	Registration from the Nominated Extension (Follow Me).....	Page 9
2.3.3	Registration from Other Extensions.....	Page 10
2.3.4	Cancellation from the Nominated Extension.....	Page 11
2.3.5	Immediate via a Separate Channel.....	Page 13
2.3.6	Immediate via the Same Channel.....	Page 16
2.3.7	On Busy via a Separate Channel.....	Page 18
2.3.8	On Busy via the Same Channel.....	Page 20
2.3.9	On No Reply via a Separate Channel.....	Page 22
2.3.10	On No Reply via the Same Channel.....	Page 25
2.3.11	Immediate on the Same PBX.....	Page 27
2.3.12	On Busy on the Same PBX.....	Page 27
2.3.13	On No Reply on the Same PBX.....	Page 27
2.3.14	Bypass of Call Diversion.....	Page 28

3	CHAINING OF CALL DIVERSIONS WITHIN DPNSS 1	Page 30
3.1	DEFINITION	Page 30
3.2	DESCRIPTION	Page 30
3.3	OUTLINE OF OPERATION	Page 30
3.3.1	Chained Diversions Immediate and/or On Busy	Page 30
3.3.2	Chained Diversions On No Reply	Page 30
3.3.3	Diversion Immediate and/or On Busy Following Diversion On No Reply	Page 31
3.3.4	Identification of the Last Controlling Extension in a Chain of Diversions	Page 32
4	COMPLIANCE	Page 33
4.1	COMPLIANCE SHEETS FOR THE DIVERSION IMMEDIATE SERVICE	Page 34
4.2	COMPLIANCE SHEETS FOR THE DIVERSION ON BUSY SERVICE	Page 39
4.3	COMPLIANCE SHEETS FOR THE DIVERSION ON NO REPLY SERVICE	Page 44

HISTORY

Issue 1 - May 1983
Issue 2 - February 1984
Issue 3 - September 1984
Issue 4 - March 1986
Issue 5 - December 1989

Issue 6 - March 2001 - Specification renamed as DPNSS[188]
- Clearing during DVG-R Call Set Up added
- Last Controlling Extension Identity added

1 GENERAL

1.1 This Section details the signalling requirements of DPNSS 1 for the Diversion Supplementary Service.

1.2 Subsection 2 details the service within DPNSS 1.

1.3 Subsection 3 details the chaining of call diversions within DPNSS 1.

1.4 Subsection 4 shows the Compliance.

1.5 The description is given in the form of Message Sequence Diagrams (MSDs) followed by explanatory text.

1.6 The text is referenced from MSDs at appropriate points in the sequences.

1.7 Message contents for successful calls are shown in MSDs. Messages and their contents for alternative sequences (eg for unsuccessful calls) are detailed in the text.

1.8 Coding of the contents of messages is given in SECTION 4.

2 CALL DIVERSION WITHIN DPNSS 1

2.1 DEFINITION

Call Diversion offers users who are absent or busy the capability of having their calls forwarded to a third party.

The following variations are specified:

- Call Diversion - Immediate,
- Call Diversion - On Busy,
- Call Diversion - On No Reply.

A common validation procedure is used for registering the nominated number from the controlling extension for the three diversion types: Immediate, On Busy and On No Reply. A special validation procedure is used when registering a new nominated number from the currently nominated extension for Diversion Immediate to give "Follow Me" Diversion.

In the case where a calling party does not want a particular call to be diverted, it is possible to bypass any call diversion that may be active. This Subsection deals only with the case of a call encountering a single diversion. Chaining of diversions is defined in Subsection 3.

IMPORTANT: When an off-PBX Diversion Immediate or On Busy is encountered, the co-operation of the Originating PBX is required in order to complete the diversion. Calls originating at PBXs which do not support this Section of the specification will consequently fail. Therefore it is essential that all PBXs capable of originating calls to destinations where off-PBX Diversion Immediate or On Busy may be encountered comply with this Section of the specification to the extent of being able to respond correctly to requests to divert.

2.2 DESCRIPTION

Registration and cancellation of call diversion may be by one or more of the following methods:

- At system configuration.
- From an operator centre.
- From a network management centre.
- By a user.

Registration at system configuration does not involve signalling and is therefore not covered. Registration and cancellation from operators, network management centres and users on PBXs other than the currently nominated number are covered in SECTION 33 (Remote Registration of Diversion).

Diversion Follow Me can be requested only from an extension currently nominated for a Diversion Immediate (see paragraph 2.3.2).

Diversion Follow Me updates the nominated extension. This allows it to be carried out an indefinite number of times but only from the currently nominated extension.

Call Diversion may be cancelled from the controlling extension (no signalling requirements) or the nominated extension (see Paragraph 2.3.4).

Registration and Cancellation of diversion may also be carried out from another extension or by an operator on the same PBX as the controlling extension. If this is done, the signalling sequences are the same as for the controlling extension carrying out the action.

Figure A shows the possible locations of a nominated extension (C) in relation to the controlling extension (B) and a calling extension (A).

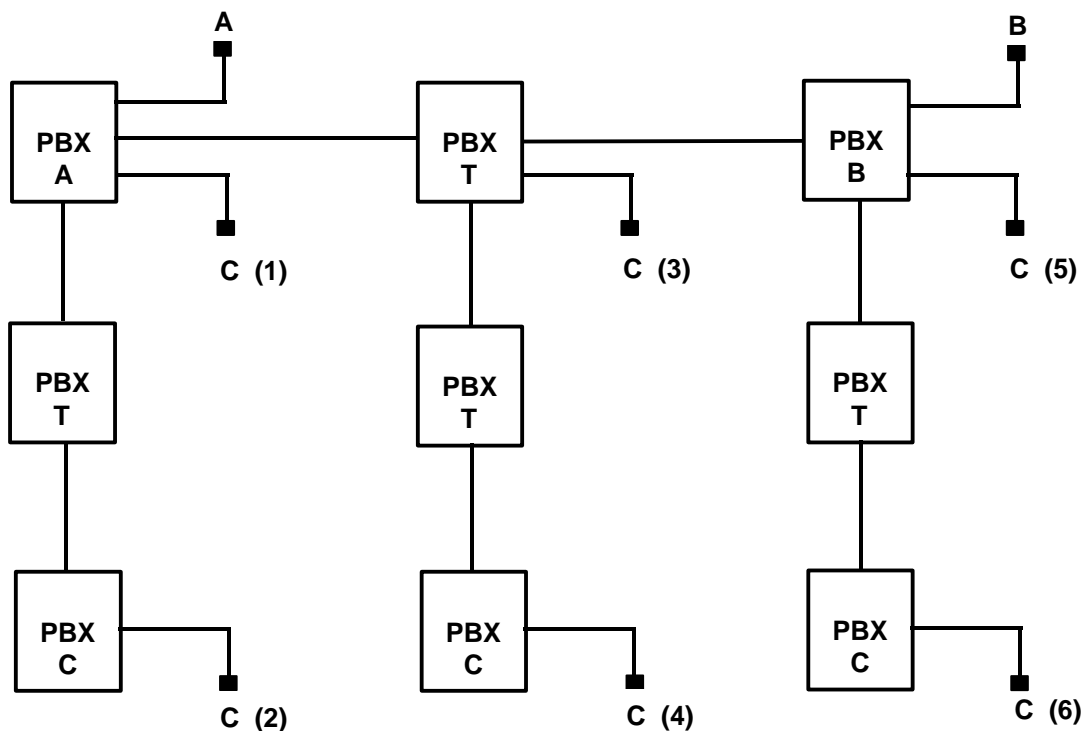

FIGURE A

The possible locations of the nominated extension C are:

- (1) On the Originating PBX (A),
- (2) On a different route from the Originating PBX,
- (3) On a Transit PBX (T) involved in the original call,
- (4) On a different route from a Transit PBX (T) on the original call,
- (5) On the original Terminating PBX (B),
- (6) On a route from the original Terminating PBX (B).

NOTE: In cases (2), (4) and (6), the Branching connection may or may not be through Transit PBXs.

2.3 OUTLINE OF OPERATION

The call diversion facilities are provided by the following signalling sequences:

- 2.3.1 Registration from the Controlling Extension
- 2.3.2 Registration from the Nominated Extension (Follow Me)
- 2.3.3 Registration from Other Extensions
- 2.3.4 Cancellation from the Nominated Extension
- 2.3.5 Immediate via a Separate Channel
- 2.3.6 Immediate via the Same Channel
- 2.3.7 On Busy via a Separate Channel
- 2.3.8 On Busy via the Same Channel
- 2.3.9 On No Reply via a Separate Channel
- 2.3.10 On No Reply via the Same Channel
- 2.3.11 Immediate on the Same PBX
- 2.3.12 On Busy on the Same PBX
- 2.3.13 On No Reply on the Same PBX
- 2.3.14 Bypass of Call Diversion

2.3.1 REGISTRATION FROM THE CONTROLLING EXTENSION

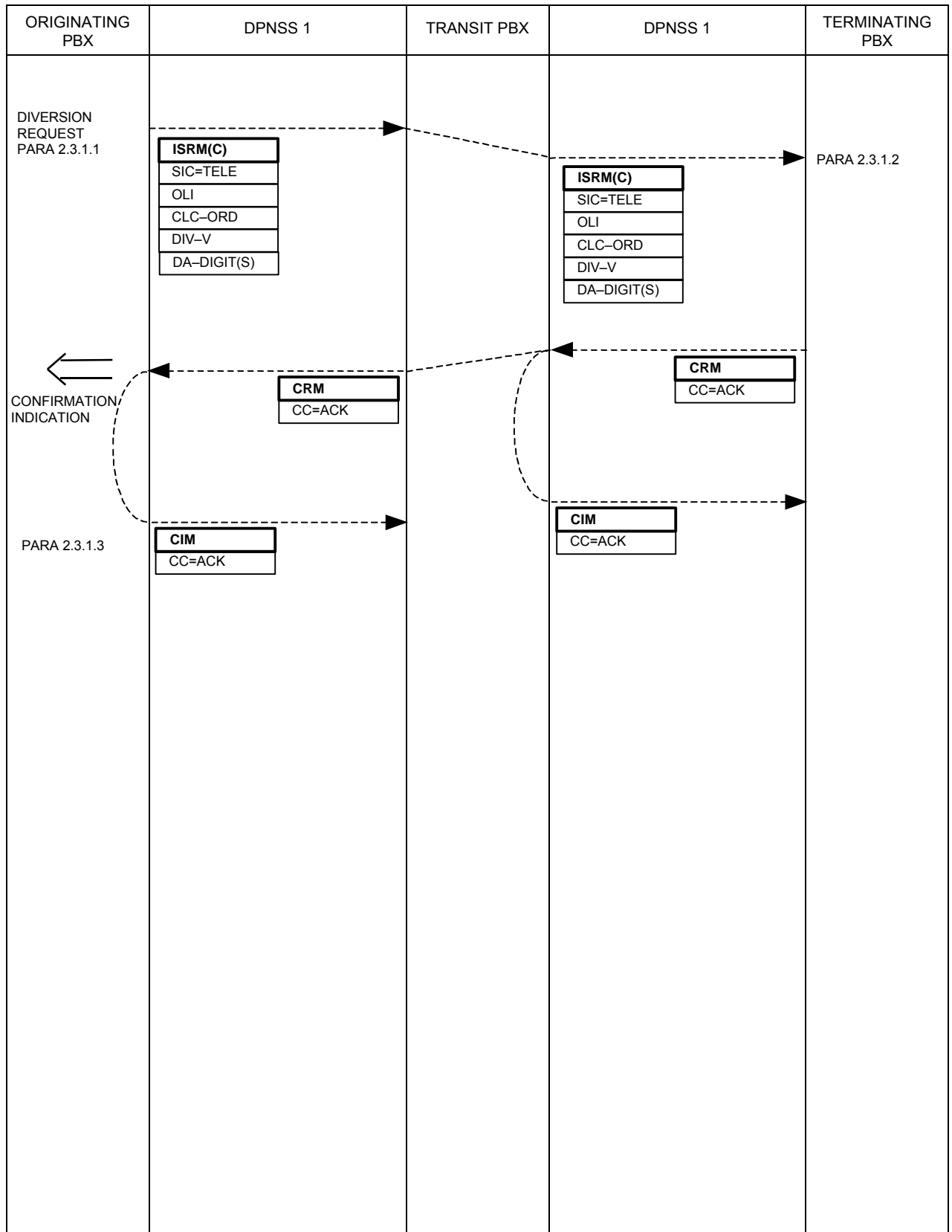

2.3.1.1 The Diversion Request is validated at the Originating PBX (some PBXs may limit the use of diversion facilities by use of appropriate internal COS codes). If the extension is allowed to have its calls diverted then a Virtual Call is established to validate the nominated extension number to confirm that calls will be diverted to a compatible extension.

2.3.1.2 The nominated extension number is validated (eg as to whether incoming calls are allowed). If the diversion is allowed, a CRM containing a Clearing Cause Acknowledge (ACK) is returned to the Originating PBX.

If diversion to a particular extension is not allowed, a CRM containing a Clearing Cause: Reject (REJ) is returned.

2.3.1.3 On receipt of the Clear Request Message (CRM) containing Clearing Cause ACK, the nominated extension number together with the diversion condition are stored against the controlling extension (cancelling any previous registration of diversion of the same type). A confirmation indication is given to the originating user.

Receipt of a CRM containing any other Clearing Cause results in a rejection indication being given to the originating user.

2.3.2 REGISTRATION FROM THE NOMINATED EXTENSION (FOLLOW ME)

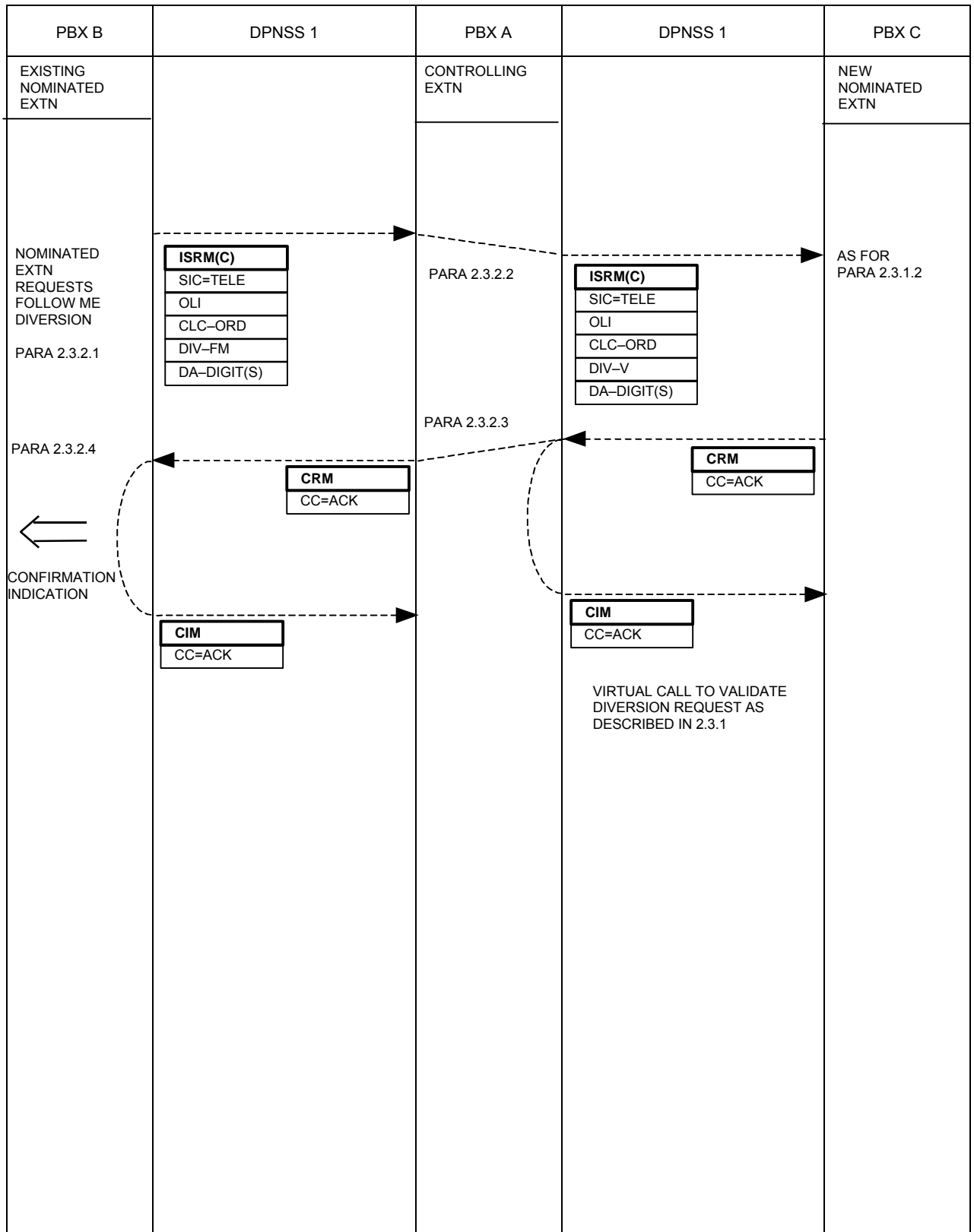

2.3.2.1 The Diversion Follow Me Request is validated at PBX B and if all of the parameters appear to be valid, a Virtual Call is established to PBX A (the PBX associated with the controlling extension).

2.3.2.2 PBX A, on receipt of the ISRM containing Diversion Follow-Me (DIV-FM) checks that extension B is the extension currently nominated by extension A for Diversion Immediate. If so, and extension A is permitted to divert calls to the new nominated number, then the sequence for Registration from the controlling extension as specified in 2.3.1 is used to validate the new nominated extension number.

If extension B is not currently nominated by extension A for Diversion Immediate, then the request is rejected by use of a Clear Request Message containing a Clearing Cause: Facility Not Registered (FNR).

If the diversion is not allowed, the request is rejected by use of a Clear Request Message containing the Clearing Cause: Reject (REJ).

2.3.2.3 If a CRM containing Clearing Cause: ACK is received from the sequence for Registration from the controlling extension, then the nominated extension number recorded against the controlling extension is updated to cause subsequent calls to be diverted to extension C instead of extension B. Following this, a CRM containing a Clearing Cause: ACK is sent to PBX B.

If a CRM containing any other Clearing Cause is received following the sequence for Registration from the controlling extension, then the diversion record is left unchanged and a CRM containing the same Clearing Cause is sent to PBX B.

2.3.2.4 On receipt of a CRM containing Clearing Cause: ACK, a confirmation indication is given to the user.

Receipt of a CRM containing a Clearing Cause other than ACK indicates that the request has failed. An appropriate indication may be given to the user.

2.3.3 REGISTRATION FROM OTHER EXTENSIONS

Remote Registration of Diversion is detailed in SECTION 33 of this specification.

2.3.4 CANCELLATION FROM THE NOMINATED EXTENSION

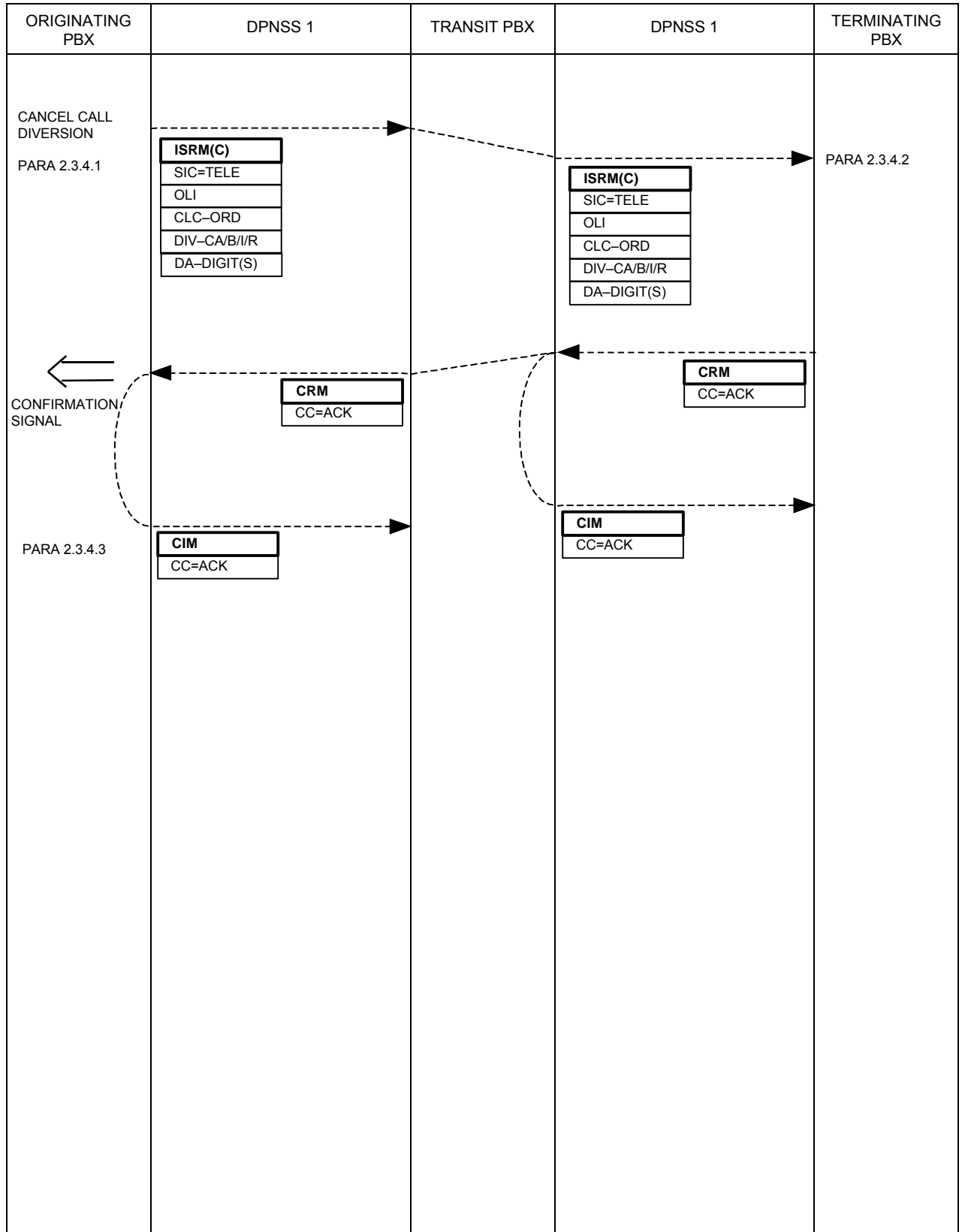

2.3.4.1 The Diversion Cancellation is validated at the Originating PBX and, if all the parameters appear to be valid, a Virtual Call is established to the distant PBX (ie the PBX associated with the controlling extension).

2.3.4.2 On receipt of the ISRM containing Diversion Cancellation (DIV-CA, DIV-CI, DIV-CB or DIV-CR), the Terminating PBX checks that the extension identified by the OLI is currently nominated for the type indicated by DIV-CI, DIV-CB or DIV-CR, or for any type in the case of DIV-CA. If the extension is currently nominated, the record for the appropriate diversion type is deleted and a CRM containing Clearing Cause: ACK is sent to the Originating PBX. In the case of DIV-CA, the records for each type of diversion where the nominated extension corresponds to the received OLI are deleted.

If the extension is not currently nominated for the type specified (or any type in the case of DIV-CA), a CRM containing Clearing Cause: FNR is sent to the Originating PBX.

2.3.4.3 On receipt of a CRM containing Clearing Cause: ACK, a confirmation indication is given to the user. Receipt of a CRM containing any other Clearing Cause results in a rejection indication being sent to the user.

2.3.5 IMMEDIATE VIA A SEPARATE CHANNEL

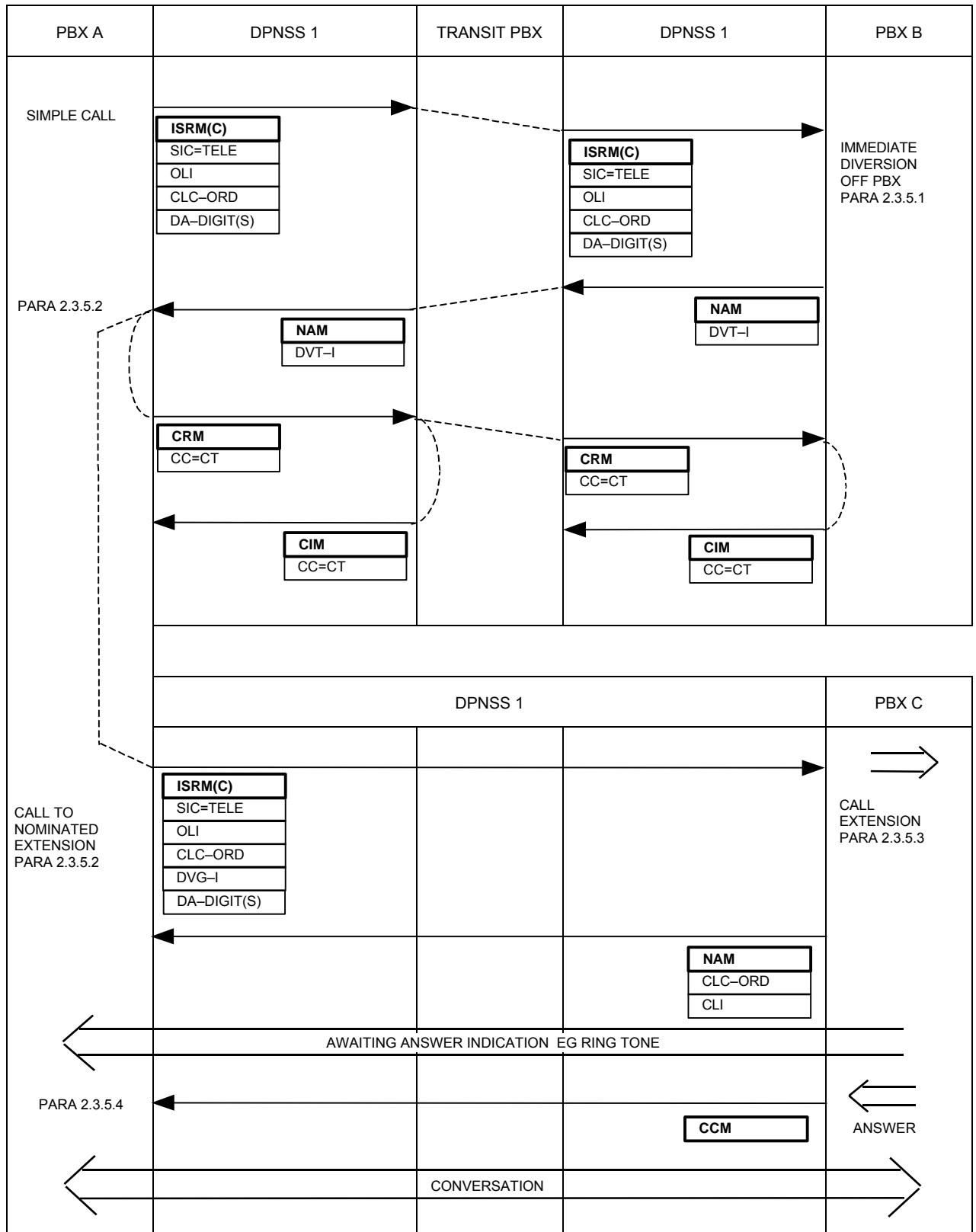

2.3.5.1 When a call terminates at an extension with Diversion Immediate active and the nominated extension is on a different PBX from the called extension then a Number Acknowledge Message (NAM) containing Divert Immediate (DVT-I) (with the Destination Address of the nominated extension as a Parameter) is returned to the Originating PBX. When the nominated extension is on the same PBX as the called extension, paragraph 2.3.11 applies.

After sending the NAM, a timeout (suggested value 10 s) is started at the B PBX to guard against non-receipt of the CRM (which should be sent in accordance with 2.3.5.2) or alternatively, in the case of Single-Channel Working, non-receipt of the RM (sent in accordance with 2.3.6.1). On expiry of the timeout, the call shall be cleared with Clearing Clause: Network Termination (NT).

If the nominated extension is the same as the originating extension then the diversion is bypassed.

2.3.5.2 When a NAM containing DVT-I is received at the Originating PBX, a new connection can be established to the nominated extension.

This sequence assumes that the nominated extension is on a different route from the original called number or that Single-Channel Working is not available on the Originating PBX or the next PBX on the route.

As Separate-Channel Working is assumed, the original connection is released by sending a CRM containing Clearing Cause: Call Termination (CT). In parallel with the release of the original connection, a new connection can be established using an Initial Service Request Message (ISRM) containing Diverting Immediate (DVG-I) with the controlling extension's identity as a Parameter.

NOTE: The DVT-I string is classed as mandatory to End PBXs. Consequently, an Originating PBX not supporting this Section of the specification will clear down the call on receipt of a NAM containing DVT-I and indicate call failure to the calling party.

2.3.5.3 On receipt of the ISRM containing DVG-I at the Terminating PBX, the call is presented to the nominated extension. Some PBXs may use a special call arrival indication to present diverted calls; some may have the capability of displaying the original called number.

If the nominated extension is free and the connection is permitted then Calling Indication signal is sent to the called extension, Awaiting Answer Indication is returned in the traffic channel and a NAM is returned in the signalling channel.

From this point on, the call is treated as a Simple Call.

If the nominated extension can not be called, then a CRM containing an appropriate Clearing Cause (eg BY, SOS) shall be returned by the Terminating PBX and a CIM expected in response. If the nominated extension is prevented from accepting diverting calls (for example due to a change of attributes since the validation was accepted) then the Clearing Cause: Service Unavailable (SU) shall be used.

2.3.5.4 On receipt of the NAM, the nominated extension number may be displayed at the originating extension (if appropriate) to indicate that the call has been diverted. From this point on, the call is treated as a Simple Call.

If a CRM is received it shall be treated as for a Simple Call (SECTION 6).

2.3.6 IMMEDIATE VIA THE SAME CHANNEL

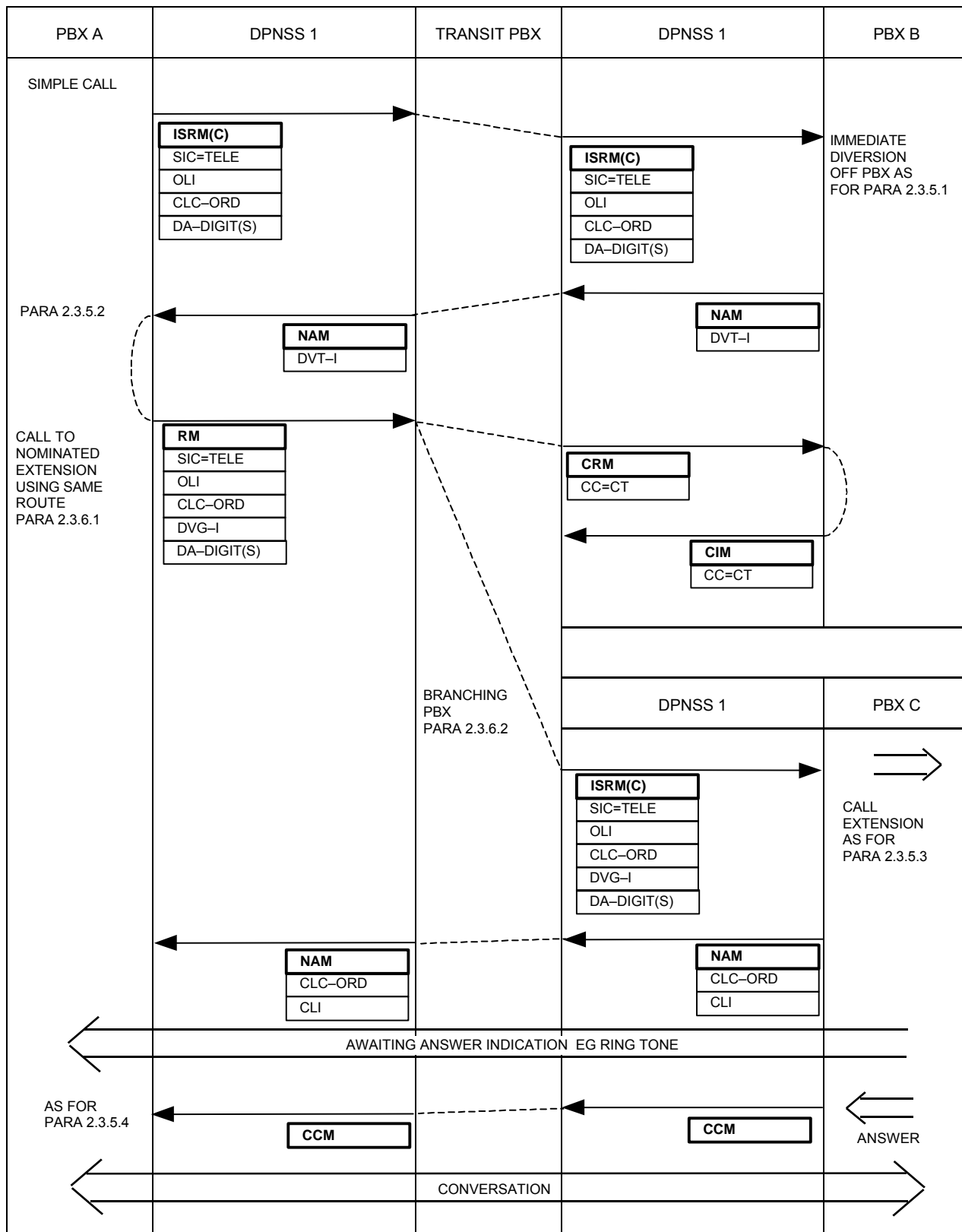

2.3.6.1 Up to this point, the sequence is identical to Separate-Channel Working. This sequence assumes that the nominated extension is on the same route as the original called number and that the next PBX can accept a Recall Message (RM) containing DVG-I to re-route the call to the nominated extension.

2.3.6.2 When the RM containing DVG-I is received at a Transit PBX and the nominated extension is on the same route as the original called number then the same outgoing channel can be used (subject to Single-Channel working being available on the next PBX). In order to illustrate a mixture of Single- and Separate-Channel Working, the sequence assumes that the call branches at the Transit PBX. It should then be possible to imagine a call re-using a number of channels in tandem and even via Transits beyond the original Terminating PBX. As branching is assumed, the original outgoing channel is cleared and released in parallel with an ISRM containing DVG-I being used to route the call on a new channel. From this point on, the call is treated in the same manner as Separate-Channel Working. However, had Single-Channel Working as far as the original Terminating PBX been used then the RM containing DVG-I would be processed as follows:

If the nominated extension is on the same PBX as the original called number (ie on-PBX Diversion Immediate has been treated as off-PBX diversion) then the call can be presented to the nominated extension as if an ISRM containing DVG-I had been received.

If the nominated extension is not on the original Terminating PBX then an ISRM will be used to route the call on an outgoing channel.

2.3.7 ON BUSY VIA A SEPARATE CHANNEL

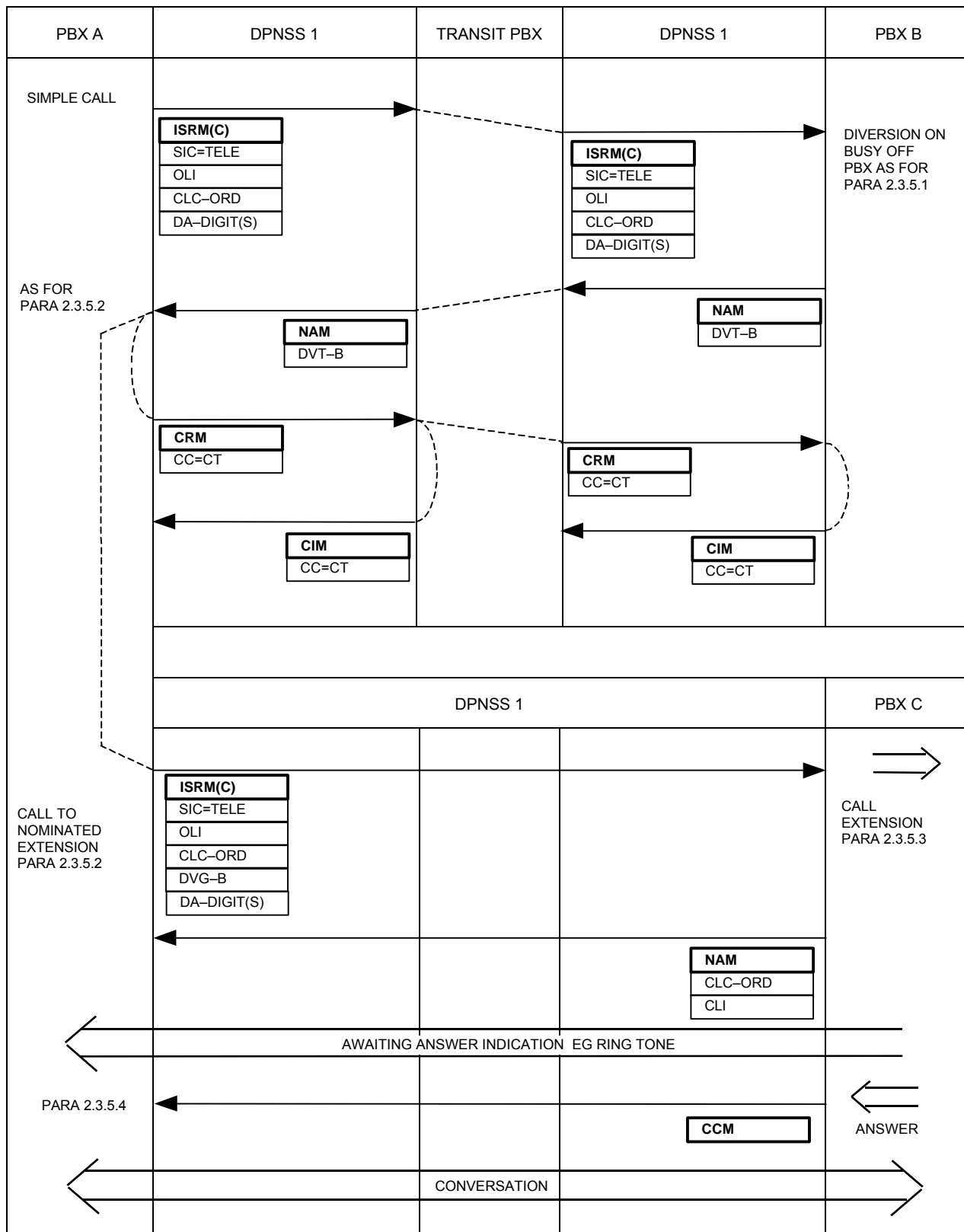

The sequence for Divert-On-Busy via a Separate Channel is essentially the same as the one for Call Diversion Immediate via a Separate Channel. Only the reason for diversion and the corresponding indication in the ISRM and NAM are different (See 2.3.5).

2.3.8 ON BUSY VIA THE SAME CHANNEL

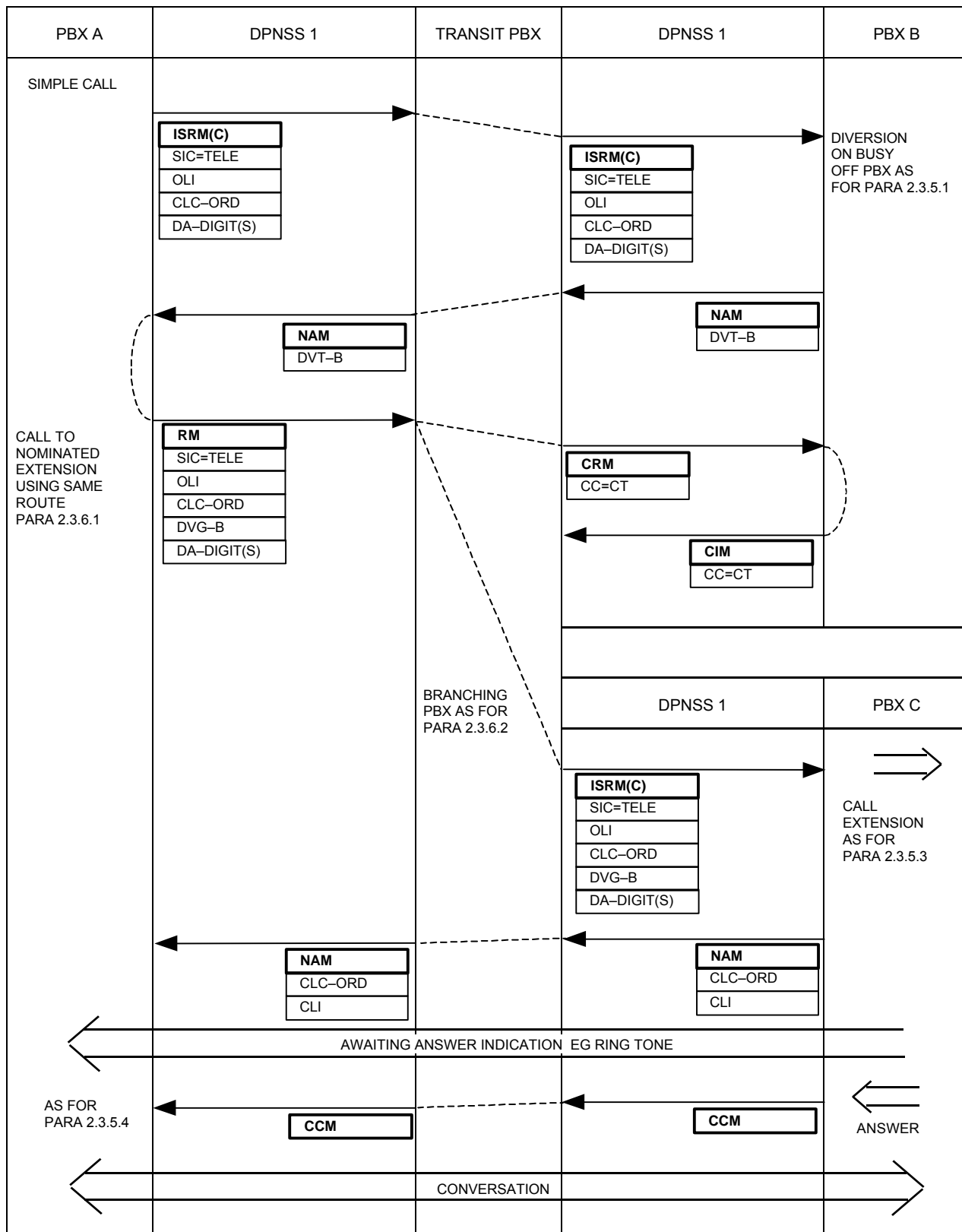

The sequence for Diversion-On-Busy via the Same Channel is essentially the same as the one for Call Diversion Immediate via the Same Channel. Only the reason for Diversion and the corresponding indication in the ISRM and NAM are different (See 2.3.6).

2.3.9 ON NO REPLY VIA A SEPARATE CHANNEL

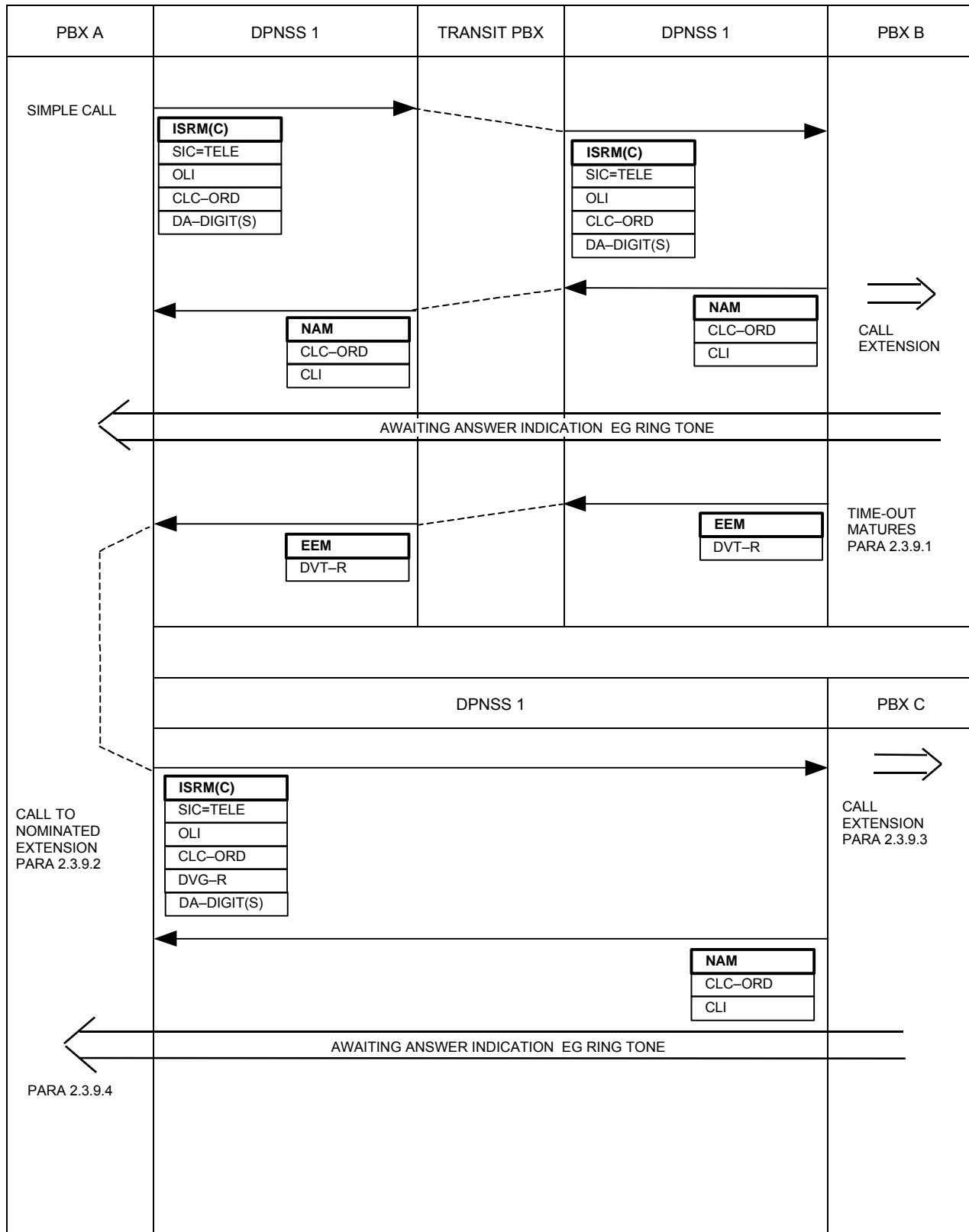

2.3.9.1 When a call terminates at an extension with Diversion On No Reply active the call will be processed in the same manner as a Simple Call. After presenting the call in the normal manner and sending a NAM, a timeout will be started. This timeout will be cancelled if the call is answered.

If the timeout matures and the nominated extension is on a different PBX from the called extension then an EEM containing Divert On No Reply (DVT-R) (with the Destination Address of the nominated extension as a Parameter) is returned to the Originating PBX. The calling signal is maintained on the original call.

Where the nominated extension is on the same PBX as the called extension then paragraph 2.3.13 applies.

2.3.9.2 On Receipt of an EEM containing Divert On No Reply (DVT-R) at the Originating PBX, an attempt is made to divert the call. This sequence assumes that the nominated extension is on a different route from the original called number or that Single-Channel Working is not available on the Originating PBX on the route.

The existing connection cannot be released until a connection has been established to the nominated extension. Therefore, a new channel is selected and a new connection established using an ISRM containing Diverting On No Reply String (DVG-R).

2.3.9.3 On receipt of the ISRM containing DVG-R at the Terminating PBX, the call is presented to the nominated extension.

Some PBXs may use a special call arrival indication to present diverted calls; some may have the capability of displaying the original called number.

If the nominated extension is free and the connection is permitted then Calling Indication is sent to the called extension, Awaiting Answer Indication is returned in the traffic channel and a NAM is returned in the signalling channel. From this point on, the call is treated as a Simple Call.

2.3.9.4 On receipt of a NAM on the new connection and before a CCM on the original connection the Originating PBX will:

- Switch the connection from the original outgoing channel to the new one;
- Clear and release the original outgoing channel;
- If appropriate, display the nominated extension number at the originating extension.

If a CCM is received on the original connection before a NAM on the new connection then the original connection is put in the Answered State and the new connection is cleared and released.

If a CRM is received on the new call, then the original connection is left in the Awaiting Answer State.

If the old connection is cleared before a NAM on the new connection has been received, either by receipt of a CRM on the old connection or by the originating extension clearing, then the new connection is cleared and released.

2.3.10 ON NO REPLY VIA THE SAME CHANNEL

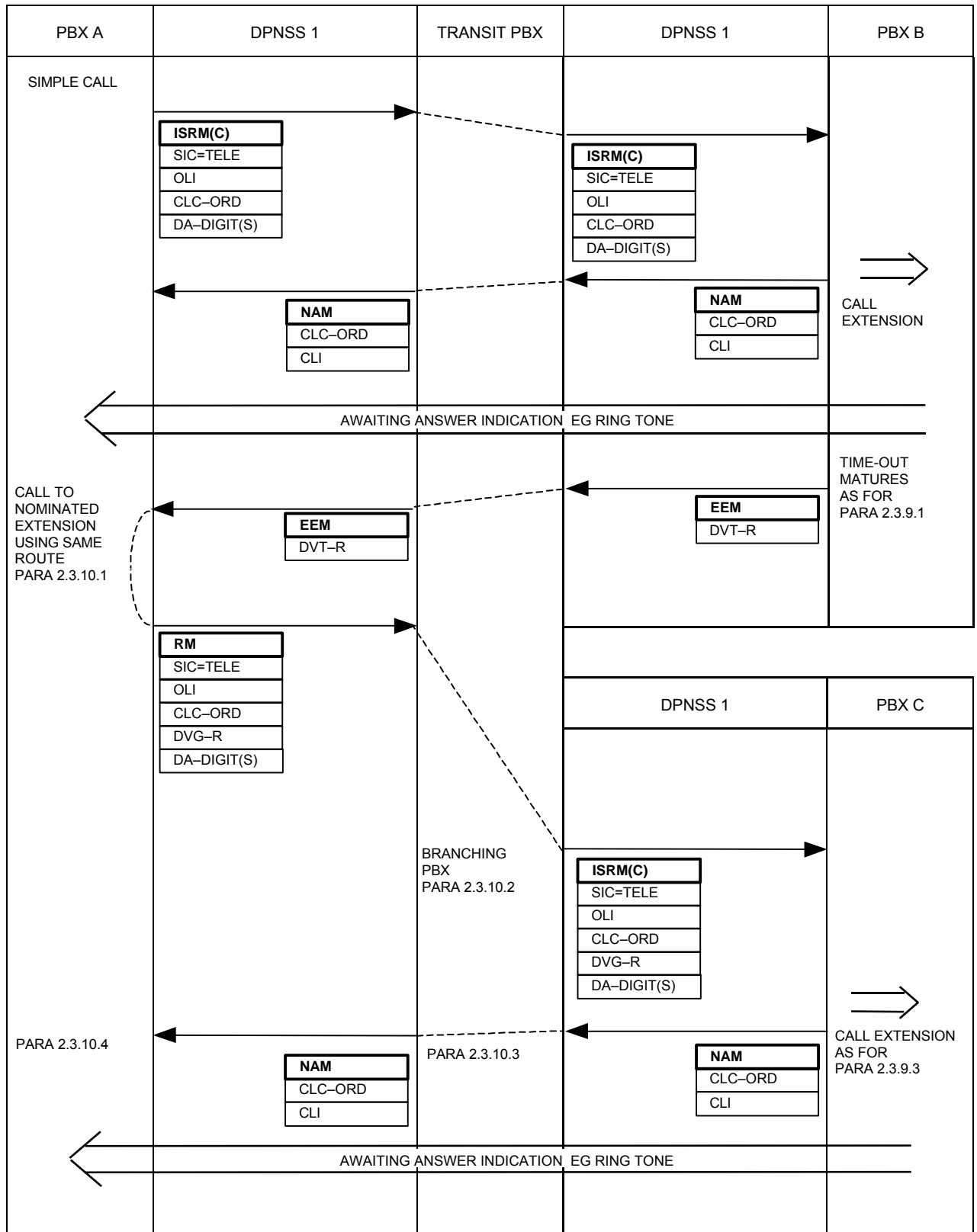

2.3.10.1 Up to this point the sequence is identical to Separate-Channel Working. This sequence assumes that the nominated extension is on the same route as the original called number and that the next PBX can accept an RM containing Diverting On No Reply (DVG-R). An RM(C) containing DVG-R is sent along the existing channel. The traffic channel is disconnected.

2.3.10.2 When the RM containing DVG-R is received at a Transit PBX and the nominated extension is on the same route as the original called number then the same outgoing channel can be used (subject to Single-Channel Working being available on the next PBX). In order to illustrate a mixture of Single-Channel and Separate-Channel Working, the sequence assumes that the call branches at the Transit PBX. It should be possible to imagine a call re-using a number of channels in tandem and even transiting on beyond the original Terminating PBX. The existing connection cannot be released until a connection has been established to the nominated extension. Therefore, a new channel is selected and a new connection established using an ISRM containing DVG-R.

2.3.10.3 On receipt of a NAM on the new connection before a Call Connected Message (CCM) on the original connection, the Branching PBX will:

- Connect the traffic channel to the new outgoing channel
- Clear and release the original outgoing channel;
- Send a NAM to the Originating PBX.

If a CCM is received on the original connection before a NAM on the new connection then the Branching PBX will:

- Clear and release the new connection;
- Send a CCM followed by an RRM containing Rejection Cause: Network Termination (NT) to the Originating PBX.

If a CRM is received on the new call, then the original connection is left in the Awaiting Answer State and an RRM containing a Rejection Cause the same as the Clearing Cause in the CRM shall be sent to the Originating PBX.

2.3.10.4 Receipt of a NAM indicates successful diversion of the call. The traffic channel is reconnected. At this point the new called number may be displayed if appropriate.

Receipt of an RRM indicates failure of the diversion and that the original called number is still being called.

If a CCM is received before receiving a NAM or a RRM, it is saved; if a NAM is subsequently received, the CCM is discarded but if a RRM is received, the CCM is processed.

2.3.11 IMMEDIATE ON THE SAME PBX

When a call terminates at an extension with Diversion Immediate active and the nominated extension is on the same PBX, the diversion is completed and (with the exception of the message contents described below) the call is handled as a Simple Call.

If the nominated extension is free, the Terminating PBX sends a NAM containing the Called Line Category and a Diverted Immediate Signal (DVD-I) (with the identity of the nominated extension as a Parameter). DVD-I is sent in place of the CLI.

If the nominated extension is busy, the Terminating PBX sends a CRM containing Clearing Cause: BY and DVD-I.

2.3.12 ON BUSY ON THE SAME PBX

This sequence is essentially the same as that for Immediate on the same PBX, except that Diverted On Busy (DVD-B) is used in place of DVD-I.

2.3.13 ON NO REPLY ON THE SAME PBX

When a call terminates at an extension with Diversion On No Reply active, the call will be processed in the same manner as a Simple Call. After the call is presented in the normal manner and the NAM is sent, a timeout will be started. This timeout will be cancelled if the call is answered.

If the timeout matures and the nominated extension is on the same PBX as the called extension and it is free then the diversion may be completed and an EEM containing Diverted On No Reply (DVD-R) (with the identity of the nominated extension as a Parameter) is sent to the Originating PBX. The CLC of the nominated extension is also included in the EEM.

If the timeout matures and the nominated extension is on the same PBX as the called extension and it is busy, the diversion cannot take place, thus no signalling is required.

2.3.14 BYPASS OF CALL DIVERSION

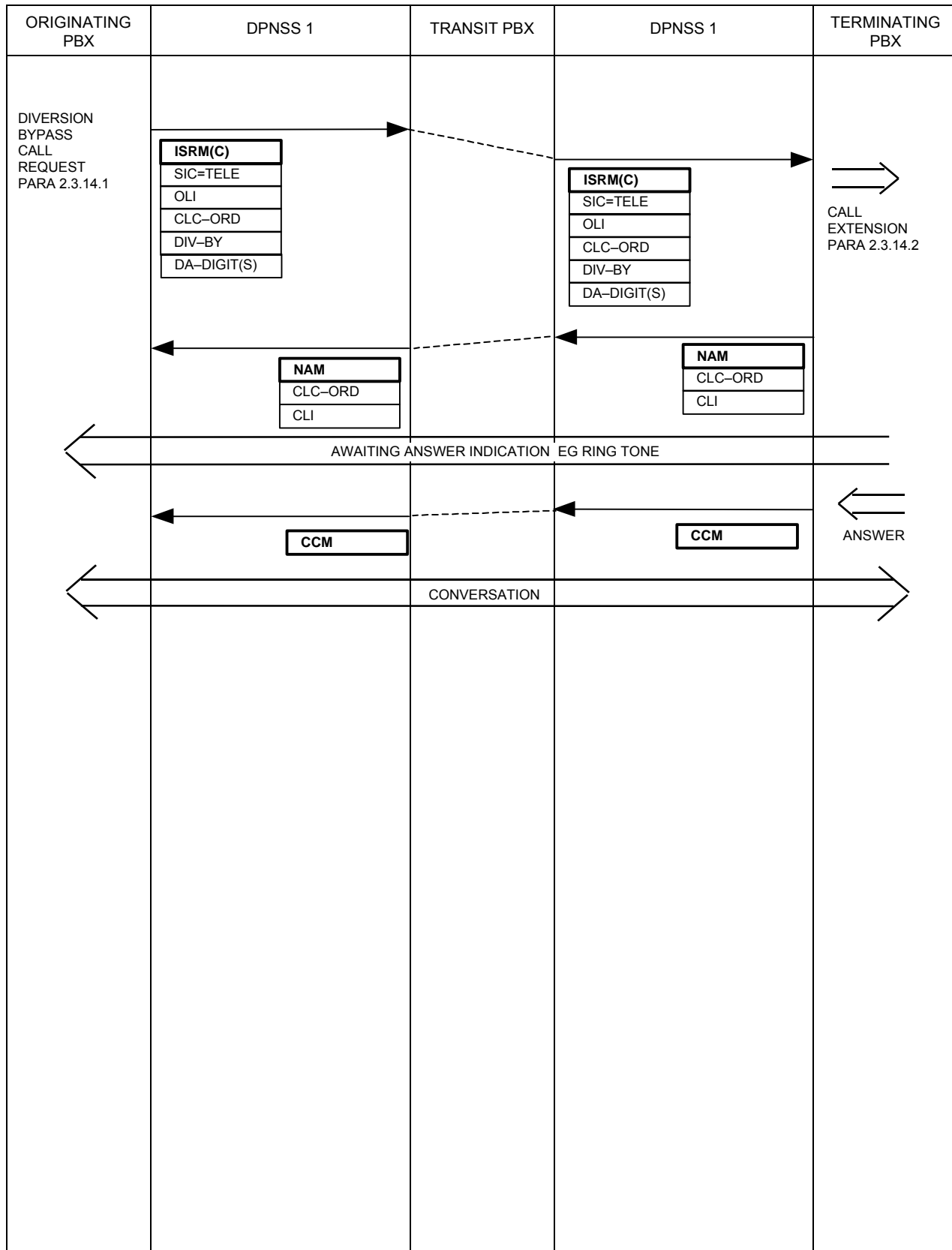

2.3.14.1 When a user requests a call with Diversion Bypass, the appropriate Supplementary Service String (DIV-BY) is included in the ISRM.

2.3.14.2 On receipt of an ISRM containing DIV-BY, the Terminating PBX will ignore any diversion (Immediate, On Busy or On No Reply) that would otherwise have been operative and process the call in the same manner as a Simple Call.

3 CHAINING OF CALL DIVERSIONS WITHIN DPNSS 1

3.1 DEFINITION

Chaining of Call Diversions offers the possibility of calls which have already been diverted undergoing further diversions.

3.2 DESCRIPTION

It is possible for a call which has undergone diversion to encounter a further diversion, either of the same type or of a different type. DPNSS 1 permits diversions to be chained in this way, but it is the responsibility of PBXs to ensure that unlimited chaining does not occur.

Since the Originating PBX has to co-operate in Off-PBX diversions, it is able to impose a limit. Terminating PBXs are responsible for limiting On-PBX diversions.

3.3 OUTLINE OF OPERATION

3.3.1 Chained Diversions Immediate and/or On Busy

3.3.1.1 On-PBX Diversions

If Diversions Immediate and/or On Busy are chained within a single PBX, the DVD-I or DVD-B string sent in the NAM or CRM reflects the first diversion but the Parameter of the String identifies the final extension.

3.3.1.2 Off-PBX Diversions

If an Off-PBX diversion occurs after a previous Off-PBX diversion, the normal rules for Diversion Immediate (paragraphs 2.3.5 and 2.3.6) and Diversion on Busy (paragraphs 2.3.7 and 2.3.8) apply. However, the Parameter of string DVG-I or DVG-B in the ISRM or RM is the ORIGINAL Destination Address.

3.3.1.3 On-PBX Diversion(s) Following Off-PBX Diversion

The rules of paragraph 3.3.1.1 apply.

3.3.1.4 Off-PBX Diversion Following On-PBX Diversion(s)

The Off-PBX diversion is carried out normally and the On-PBX diversion(s) is/are not signalled.

3.3.2 Chained Diversions On No Reply

3.3.2.1 On-PBX Diversions

Each On-PBX Diversion On No Reply obeys the rules of Paragraph 2.3.13.

3.3.2.2 Off-PBX Diversions

Each Off-PBX Diversion on No Reply obeys the rules of Paragraph 2.3.9 or 2.3.10. However, the Parameter of string DVG-R in the ISRM or RM is the ORIGINAL Destination Address.

3.3.3 Diversion Immediate and/or On Busy Following Diversion On No Reply

3.3.3.1 On-PBX

The rules for On-PBX Diversion on No Reply (Paragraph 2.3.13) apply.

The other diversion(s) is/are not signalled. The Parameter of DVD-R identifies the final extension.

3.3.3.2 Off-PBX

Off-PBX Diversion Immediate or On Busy may occur after Off-PBX Diversion On No Reply. On receipt of the ISRM containing DVG-R, the Terminating PBX clears the new call by sending a CRM containing Clearing Cause: ACK, and either DVT-I or DVT-B.

The Originating PBX, on receipt of a CRM containing Clearing Cause: ACK and either DVT-I or DVT-B, responds with a CIM. Alternatively, if Single-Channel Working is being used, the Originating PBX will receive an RRM with Rejection Cause: ACK and either DVT-I or DVT-B. The original ringing call is maintained and a third call is established to the address given in the DVT-I or DVT-B string. This call is set up according to the rules for Diverting on No Reply (paragraph 2.3.9 or 2.3.10), with string DVG-R (not DVG-I or DVG-B) being sent in the ISRM or RM. The Parameter of DVG-R is the ORIGINAL Destination Address.

3.3.3.3 Off-PBX Diversion Immediate and/or On Busy Following On-PBX Diversion On No Reply

The normal procedure for On-PBX Diversion On No Reply does not apply and the Diversion Immediate and/or On Busy is carried out using the rules for Off-PBX diversion on No Reply (paragraph 2.3.9 or 2.3.10), with string DVT-R being sent in the EEM and string DVG-R in the ISRM or RM. The Parameter of DVG-R is the ORIGINAL Destination Address.

3.3.3.4 On-PBX Diversion Immediate and/or On Busy Following Off-PBX Diversion On No Reply

An On-PBX Diversion Immediate and/or On Busy following Off-PBX Diversion On No Reply is indicated by string DVD-I or DVD-B in the NAM. If more than one On-PBX diversion occurs, the string sent (DVD-I or DVD-B) reflects the first one but the Parameter identifies the final extension.

3.3.4 Identification of the Last Controlling Extension in a Chain of Diversions.

The identity of the last controlling extension in a chain of diversions may be indicated by sending DVL. DVL also indicates the type of diversion and whether or not presentation restriction applies to the last controlling extension's identity. DVL may accompany:

- DVT-I, DVT-B or DVT-R when a Controlling PBX requests the Originating PBX to perform a diversion. DVL may be used in this case to indicate the identity of the controlling extension when the off-PBX diversion that is being requested has been preceded by an on-PBX diversion at the Controlling PBX.
- DVD-I, DVD-B, DVD-R or DVD-E (See DPNSS[189]) when the Controlling PBX informs the Originating PBX that an on-PBX diversion has taken place. DVL may be used in this case to indicate the identity of the last controlling extension when a chain of two or more on-PBX diversions has been followed at the Controlling PBX.
- DVG-I, DVG-B or DVG-R, when an Originating PBX initiates the diverting leg of a call. DVL may be used in this case when following a chain of diversions to indicate the identity of the controlling extension of the current diversion.

4 COMPLIANCE SHEETS FOR SUPPLEMENTARY SERVICE: DIVERSION

The Diversion Supplementary Service may be split into three types and each is an optional part of DPNSS 1, and their provision on a PBX is a matter for negotiation between a customer and his supplier (see FOREWORD in SECTION 0 of this specification). This Subsection may be used as an aid to those negotiations.

NOTE: Whilst the provision of each type of Diversion is optional, if a version is provided, compliance with certain features of that version becomes mandatory.

Compliance with the service is considered in terms of the function(s) to be performed by the PBX, ie Transit, End or Branching, and the extent to which extensions on the PBX can request the service.

The Diversion Service is split into three types:

- Diversion Immediate,
- Diversion on No Reply,
- Diversion on Busy.

The Compliance Tables are allocated a separate Subsection for each type of Diversion.

TABLE 0 should be completed by a manufacturer to indicate PBX capability and by a purchaser to indicate PBX requirements.

TABLE 0

SERVICE		APPLICABLE SUBSECTION OF COMPLIANCE SHEETS
Diversion Immediate		4.1
Diversion on Busy		4.2
Diversion on No Reply		4.3

4.1 COMPLIANCE SHEETS FOR THE DIVERSION IMMEDIATE SERVICE

The options available are given in TABLE 1. This table should be completed by a manufacturer to indicate PBX capability and by a purchaser to indicate PBX requirements.

TABLES 2 to 6 indicate the features which are required/provided at each PBX. The pre-printed "YES" indicates that the feature is a mandatory part of the service for that PBX function.

It should be noted that the Diversion Immediate Service requires co-operation between the PBXs involved in a call, and unless all of the PBXs in a private network support the service, the extension users will experience inconsistent results.

TABLE 1

PBX FUNCTION		APPLICABLE TABLE
PBX with operators or extensions, some of which can request the service.		TABLES 2 & 4
PBX supporting Single-Channel Working for the service with operators or extensions some of which can request the service.		TABLES 2,3 and 4
PBX with operators or extensions, none of which can request the service.		TABLE 2
Transit PBX.		TABLE 5
Transit PBX supporting Single-Channel Working for the service.		TABLES 5 and 6

TABLE 2

COMPLIANCE TABLE FOR A PBX WITH OPERATORS OR EXTENSIONS IN A NETWORK THAT SUPPORTS THE DIVERSION IMMEDIATE SERVICE		
SERVICE VARIANT		COMMENT
Able to make a diverted call via a separate channel on receipt of a Divert-Immediate instruction from a called extension on another DPNSS 1 PBX?	YES	
Able to make a diverted call to a PBX extension on receipt of a Divert- Immediate instruction from a called extension on another DPNSS 1 PBX?	YES	
Able to accept Diverted-Immediate calls via a separate channel from other DPNSS 1 PBXs?	YES	
Able to process a Diversion Validation Request from other DPNSS 1 PBXs ?	YES	
Extensions on the PBX able to request Follow-Me Diversion to extensions on other DPNSS 1 PBXs?		
Able to request, from the nominated extension, cancellation of the Diversion-Immediate Instruction on another DPNSS 1 PBX?		
Able to request Bypass of Diversion when it is encountered on another DPNSS 1 PBX?		
Able, whilst following a chain of diversions, to indicate the identity of the current controlling extension on a call when making a Divert-Immediate call to another DPNSS 1 PBX?		

TABLE 3

COMPLIANCE TABLE FOR A PBX WITH OPERATORS OR EXTENSIONS IN ANETWORK THAT SUPPORTS THE DIVERSION IMMEDIATE SERVICE USING SINGLE-CHANNEL WORKING		
SERVICE VARIANT		COMMENT
Able to make a Diverted-Immediate Call via the same channel as the original call on receipt of a Divert instruction from a called extension on another DPNSS 1 PBX?	YES	
Able to accept Diverted-Immediate Calls via the same channel from another DPNSS 1 PBX?	YES	

TABLE 4

ADDITIONAL COMPLIANCE TABLE FOR A PBX WITH EXTENSIONS THAT ARE CAPABLE OF HAVING THEIR CALLS DIVERTED IMMEDIATE		
SERVICE VARIANT		COMMENT
Able to process a Diversion-Follow-Me Request or Cancellation from other DPNSS 1 PBXs?	YES	
Able to Bypass Diversion on own PBX extensions when requested by other DPNSS 1 PBXs?	YES	
Able to inform another DPNSS 1 PBX that an incoming call has been Diverted Immediate to an extension within the PBX?	YES	
Able to make a diverted call to another PBX when Diversion Immediate is encountered on a call between extensions on the PBX?	YES	
Extensions on the PBX able to register a request that incoming DPNSS 1 calls are Diverted Immediate to extensions on other PBXs?		
Able to instruct incoming calls to Divert Immediate to extensions on other PBXs?	YES	
Able to process a Diversion-Immediate Cancellation from other DPNSS 1 PBXs?	YES	
Able to make a Diversion Validation Request to other DPNSS 1 PBXs?	YES	
Able, following one or more on-PBX diversions, to indicate the identity of the last controlling extension when instructing an incoming call to Divert Immediate?		
Able, following more than one on-PBX diversion, to indicate the identity of the last controlling extension when a call has been Diverted-Immediate to an extension within the PBX?		

TABLE 5

COMPLIANCE TABLE FOR A TRANSIT PBX IN A NETWORK THAT SUPPORTS THE DIVERSION IMMEDIATE SERVICE		
SERVICE VARIANT		COMMENT
Able to act as a Transit PBX for Diverted-Immediate Calls received on a separate channel to the original call?	YES	Inherent DPNSS 1 capability

TABLE 6

COMPLIANCE TABLE FOR A TRANSIT PBX IN A NETWORK THAT SUPPORTS THE DIVERSION IMMEDIATE SERVICE USING SINGLE-CHANNEL WORKING		
SERVICE VARIANT		COMMENT
Able to act as a Transit PBX for Diverted-Immediate Calls received on the same channel as the original call?	YES	
Able to act as a Branching PBX for Diverted-Immediate calls?		

4.2 COMPLIANCE SHEETS FOR THE DIVERSION-ON-BUSY SERVICE

The options available are given in TABLE 1. This table should be completed by a manufacturer to indicate PBX capability and by a purchaser to indicate PBX requirements.

TABLES 2 to 6 indicate the features which are required/provided at each PBX. The pre-printed "YES" indicates that the feature is a mandatory part of the service for that PBX function.

It should be noted that the Diversion-On-Busy Service requires co-operation between the PBXs involved in a call and unless all of the PBXs in a private network support the service, the extension users will experience inconsistent results.

TABLE 1

PBX FUNCTION	APPLICABLE TABLE
PBX with operators or extensions, some of which can request the service	TABLES 2 & 4
PBX supporting Single-Channel Working for the service with operators or extensions some of which can request the service.	TABLES 2,3 and 4
PBX with operators or extensions, none of which can request the service.	TABLE 2
Transit PBX.	TABLE 5
Transit PBX supporting Single-Channel Working for the service.	TABLES 5 and 6

TABLE 2

COMPLIANCE TABLE FOR A PBX WITH OPERATORS OR EXTENSIONS IN A NETWORK THAT SUPPORTS THE DIVERSION-ON-BUSY SERVICE		
SERVICE VARIANT		COMMENT
Able to make a diverted call via a separate channel on receipt of a Divert-On-Busy instruction from a called extension on another DPNSS 1 PBX?	YES	
Able to make a diverted call to a PBX extension on receipt of a Divert-On-Busy instruction from a called extension on another DPNSS 1 PBX?	YES	
Able to accept Diverted-On-Busy calls via a separate channel from other DPNSS 1 PBXs?	YES	
Able to process a Diversion Validation Request from other DPNSS 1 PBXs ?	YES	
Able to request, from the nominated extension, cancellation of the Diversion-On-Busy Instruction on another DPNSS 1 PBX?		
Able to request Bypass of Diversion when it is encountered on another DPNSS 1 PBX?		
Able, whilst following a chain of diversions, to indicate the identity of the current controlling extension on a call when making a Divert-On-Busy call to another DPNSS 1 PBX?		

TABLE 3

COMPLIANCE TABLE FOR A PBX WITH OPERATORS OR EXTENSIONS IN A NETWORK THAT SUPPORTS THE DIVERSION-ON-BUSY SERVICE USING SINGLE-CHANNEL WORKING		
SERVICE VARIANT		COMMENT
Able to make a Diverted-On-Busy Call via the same channel as the original call on receipt of a Divert instruction from a called extension on another DPNSS 1 PBX?	YES	
Able to accept Diverted-Immediate Calls via the same channel from another DPNSS 1 PBX?	YES	

TABLE 4

ADDITIONAL COMPLIANCE TABLE FOR A PBX WITH EXTENSIONS THAT ARE CAPABLE OF HAVING THEIR CALLS DIVERTED-ON-BUSY		
SERVICE VARIANT		COMMENT
Able to Bypass Diversion on own PBX extensions when requested by other DPNSS 1 PBXs?	YES	
Able to inform another DPNSS 1 PBX that an incoming call has been Diverted-On-Busy to an extension within the PBX?	YES	
Able to make a diverted call to another PBX when Diversion-On-Busy is encountered on a call between extensions on the PBX?	YES	
Extensions on the PBX able to register a request that incoming DPNSS 1 calls are Diverted-On-Busy to extensions on other PBXs?		
Able to instruct incoming calls to Divert-On-Busy to extensions on other PBXs?	YES	
Able to process a Diversion-On-Busy cancellation from other DPNSS 1 PBXs?	YES	
Able to make a Diversion Validation Request to other DPNSS 1 PBXs?	YES	
Able, following one or more on-PBX diversions, to indicate the identity of the last controlling extension when instructing an incoming call to Divert-On-Busy?		
Able, following more than one on-PBX diversion, to indicate the identity of the last controlling extension when a call has been Diverted-On-Busy to an extension within the PBX?		

TABLE 5

COMPLIANCE TABLE FOR A TRANSIT PBX IN A NETWORK THAT SUPPORTS THE DIVERSION-ON-BUSY SERVICE		
SERVICE VARIANT		COMMENT
Able to act as a Transit PBX for Diverted-On-Busy Calls received on a separate channel to the original call?	YES	Inherent DPNSS 1 capability

TABLE 6

COMPLIANCE TABLE FOR A TRANSIT PBX IN A NETWORK THAT SUPPORTS THE DIVERSION-ON-BUSY SERVICE USING SINGLE-CHANNEL WORKING		
SERVICE VARIANT		COMMENT
Able to act as a Transit PBX for Diverted-On-Busy Calls received on the same channel as the original call?	YES	
Able to act as a Branching PBX for Diverted-On-Busy calls?		

4.3 COMPLIANCE SHEETS FOR THE DIVERSION-ON-NO-REPLY SERVICE

The options available are given in TABLE 1. This table should be completed by a manufacturer to indicate PBX capability and by a purchaser to indicate PBX requirements.

TABLES 2 to 6 indicate the features which are required/provided at each PBX. The pre-printed "YES" indicates that the feature is a mandatory part of the service for that PBX function.

It should be noted that the Diversion-on-No-Reply Service requires co-operation between the PBXs involved in a call and unless all of the PBXs in a private network support the service, the extension users will experience inconsistent results.

TABLE 1

PBX FUNCTION		APPLICABLE TABLE
PBX with operators or extensions, some of which can request the service.		TABLES 2 & 4
PBX supporting Single-Channel Working for the service with operators or extension some of which can request the service.		TABLES 2,3 and 4
PBX with operators or extensions, none of which can request the service.		TABLE 2
Transit PBX.		TABLE 5
Transit PBX supporting Single-Channel Working for the service.		TABLES 5 and 6

TABLE 2

COMPLIANCE TABLE FOR A PBX WITH OPERATORS OR EXTENSIONS IN A NETWORK THAT SUPPORTS THE DIVERSION-ON-NO-REPLY SERVICE		
SERVICE VARIANT		COMMENT
Able to make a diverted call via a separate channel on receipt of a Divert- On-No-Reply instruction from a called extension on another DPNSS 1 PBX?	YES	
Able to make a diverted call to a PBX extension on receipt of a Divert-On-No-Reply instruction from a called extension on another DPNSS 1 PBX?	YES	
Able to accept Diverted-On-No-Reply calls via a separate channel from other DPNSS 1 PBXs?	YES	
Able to process a Diversion Validation Request from other DPNSS 1 PBXs ?	YES	
Able to request, from the nominated extension, cancellation of the Diversion-On-No-Reply Instruction on another DPNSS 1 PBX?		
Able to request Bypass of Diversion when it is encountered on another DPNSS 1 PBX?		
Able, whilst following a chain of diversions, to indicate the identity of the current controlling extension on a call when making a Divert-On-No-Reply call to another DPNSS 1 PBX?		

TABLE 3

COMPLIANCE TABLE FOR A PBX WITH OPERATORS OR EXTENSIONS IN A NETWORK THAT SUPPORTS THE DIVERSION-ON-NO-REPLY SERVICE USING SINGLE-CHANNEL WORKING		
SERVICE VARIANT		COMMENT
Able to make a Diverted-On-No-Reply Call via the same channel as the original call on receipt of a Divert instruction from a called extension on another DPNSS 1 PBX?	YES	
Able to accept Diverted-On-No-Reply Calls via the same channel from another DPNSS 1 PBX via the same channel?	YES	

TABLE 4

ADDITIONAL COMPLIANCE TABLE FOR A PBX WITH EXTENSIONS THAT ARE CAPABLE OF HAVING THEIR CALLS DIVERTED-ON-NO-REPLY		
SERVICE VARIANT		COMMENT
Able to process a Diversion-On-No-Reply Request or cancellation from other DPNSS 1 PBXs?	YES	
Able to Bypass Diversion on own PBX extensions when requested by other DPNSS 1 PBXs?	YES	
Able to inform another DPNSS 1 PBX that an incoming call has been Diverted-On-No-Reply to an extension within the PBX?	YES	
Able to make a diverted call to another PBX when Diversion-On-No-Reply being encountered on a call between extensions on the PBX?	YES	
Extensions on the PBX able to register a request that incoming DPNSS 1 calls are Diverted-On-No-Reply to extensions on other PBXs?		
Able to instruct incoming calls to Divert-On-No-Reply to extensions on other PBXs?	YES	
Able to make a Diversion Validation Request to other DPNSS 1 PBXs?	YES	
Able, following one or more on-PBX diversions, to indicate the identity of the last controlling extension when instructing an incoming call to Divert-On-No-Reply?		
Able, following more than one on-PBX diversion, to indicate the identity of the last controlling extension when a call has been Diverted-On-No-Reply to an extension within the PBX?		

TABLE 5

COMPLIANCE TABLE FOR A TRANSIT PBX IN A NETWORK THAT SUPPORTS THE DIVERSION-ON-NO-REPLY SERVICE		
SERVICE VARIANT		COMMENT
Able to act as a Transit PBX for Diverted-On-No-Reply calls received on a separate channel to the original call?	YES	Inherent DPNSS 1 capability

TABLE 6

COMPLIANCE TABLE FOR A TRANSIT PBX IN A NETWORK THAT SUPPORTS THE DIVERSION-ON-NO-REPLY SERVICE USING SINGLE-CHANNEL WORKING		
SERVICE VARIANT		COMMENT
Able to act as a Transit PBX for Diverted-On-No-Reply Calls received on the same channel as the original call?	YES	
Able to act as a Branching PBX for Diverted-On-No-Reply calls?		

DIGITAL PRIVATE NETWORK SIGNALLING SYSTEM NO 1 (DPNSS 1)

SECTION 12 - SUPPLEMENTARY SERVICE : HOLD

CONTENTS

1	GENERAL	Page 2
2	HOLD SERVICE WITHIN DPNSS 1	Page 3
	2.1 DEFINITION.....	Page 3
	2.2 DESCRIPTION.....	Page 3
	2.3 OUTLINE OF OPERATION.....	Page 3
	2.3.1 Hold Service.....	Page 4
3	COMPLIANCE	Page 7

HISTORY

Issue 1 - February 1984
Issue 2 - September 1984
Issue 3 - March 1986
Issue 4 - December 1989

Issue 5 - March 2001 - Specification renamed as DPNSS[188]

1 GENERAL

- 1.1** This Section details the signalling requirements of DPNSS 1 for the Hold Supplementary Service.
- 1.2** Subsection 2 details the service within DPNSS 1.
- 1.3** Subsection 3 shows the Compliance.
- 1.4** The description is given in the form of Message Sequence Diagrams (MSDs) followed by explanatory text.
- 1.5** The text is referenced from MSDs at appropriate points in the sequences.
- 1.6** Message contents for successful calls are shown in MSDs. Messages and their contents for alternative sequences (eg for unsuccessful calls) are detailed in the text.
- 1.7** Coding of the contents of messages is given in SECTION 4.

2 HOLD SERVICE WITHIN DPNSS 1

2.1 DEFINITION

The Hold Supplementary Service permits an extension user to hold an existing call to a second party, either for privacy reasons or in order to make use of another Supplementary Service such as establishing an Enquiry Call or answering a waiting call.

2.2 DESCRIPTION

This Supplementary Service permits a user to place an existing call into a suspended state, with the possibility of a holding indication being given to the held extension. The user may at any time reconnect to the Held Call, removing any holding indication.

This Supplementary Service enables a holding indication (eg music, silence) to be applied locally to the held party.

This Supplementary Service offers the possibility of preventing certain types of party being placed on Hold.

This Supplementary Service offers the possibility of preventing both parties having Hold invoked at the same time, thus avoiding possible confusion to users.

If a user who has a call on Hold clears, calling signal may be applied to that extension and the held call reconnected on answer. Some designs of PBX may permit a holding extension to clear and not be called back immediately.

While a call is on Hold, the holding user may perform various actions such as establishing an Enquiry Call (Three Party Service Invocation) or answering a waiting call.

2.3 OUTLINE OF OPERATION

The Hold Supplementary Service is implemented using the signal sequences given in paragraph 2.3.1.

2.3.1 HOLD SERVICE

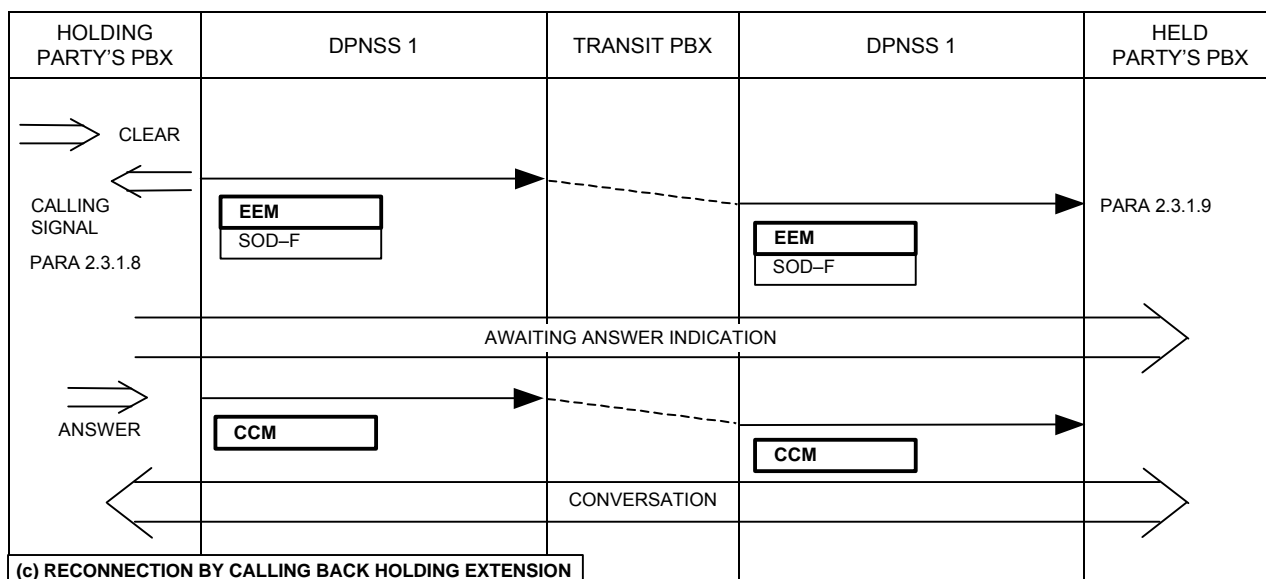
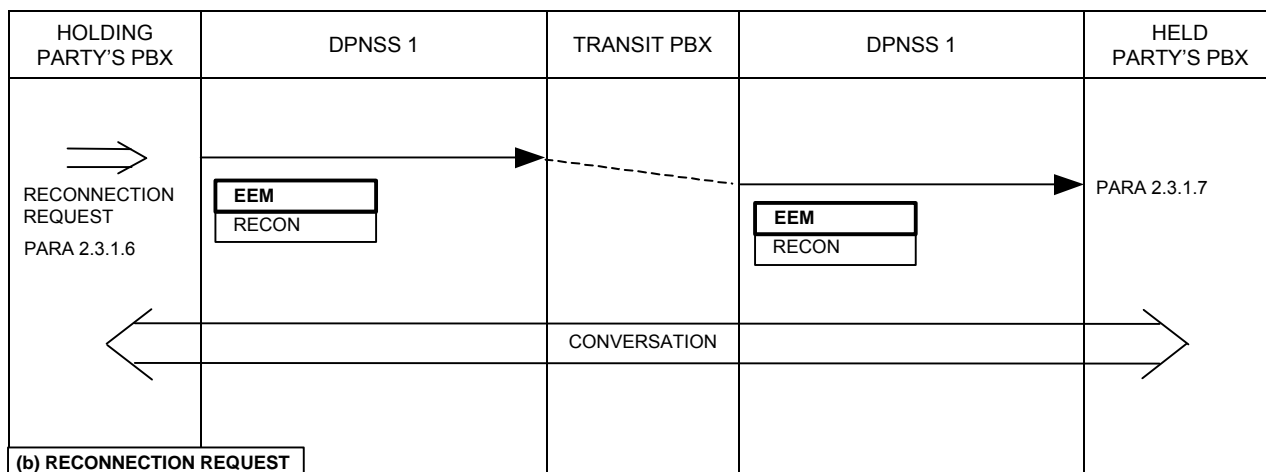
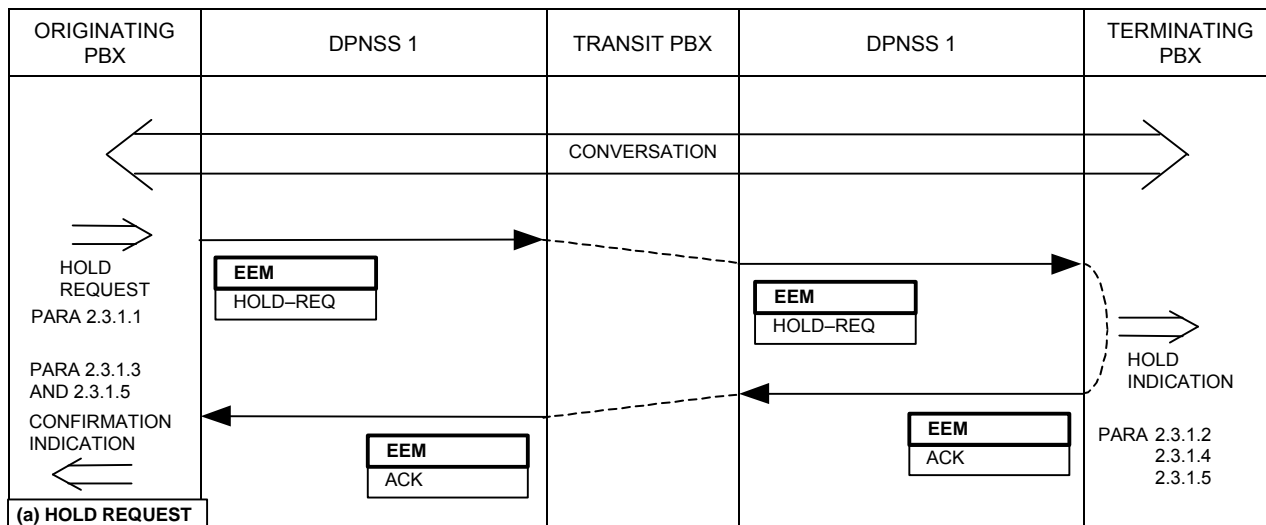

2.3.1.1 Either party of a call in the conversation state may request Hold. An EEM containing Hold Request (HOLD-REQ) is sent to the other party's PBX.

2.3.1.2 On receipt of the Hold Request the other party's PBX checks that the extension can be placed on Hold, and if so disconnects the traffic path across the PBX (maintaining the connection across the network), applies holding indication, and returns an EEM containing Acknowledge (ACK).

If Hold is not permitted the request may be rejected by returning an EEM containing Reject (REJ) for example when:

- i. The other extension is of a type which is not permitted to be placed on Hold.
- ii. The other extension is already holding the call or has made a Hold Request.

2.3.1.3 On receipt of an EEM containing Acknowledge (ACK), the requesting extension's PBX disconnects the extension's traffic channel across the PBX (maintaining the connection across the network) and gives an appropriate indication (eg dial tone) to show that the Hold Request was successful.

On receipt of an EEM containing REJ the requesting extension's PBX rejects the Hold Request.

If the target PBX does not support the Hold service it replies with an EEM containing Signal Not Understood (SNU). In this case the requesting extension's PBX may still proceed as if the Hold Request had been successful, although there is no protection from the other extension putting the call on local hold.

2.3.1.4 Any subsequent Hold Request by the held extension can be rejected by its own PBX without the need for DPNSS 1 signalling.

2.3.1.5 If the held extension subsequently clears, or if the holding extension requests termination of the Held Call, the clear down sequences for a Simple Call (SECTION 6) apply.

2.3.1.6 If the holding user requests reconnection, the traffic channel is reconnected and an EEM containing Reconnected (RECON) is sent to the held extension's PBX.

2.3.1.7 On receipt of an EEM containing RECON, the held extension's PBX reconnects the traffic channel and removes holding indication.

2.3.1.8 If the holding extension clears, its PBX may apply calling signal either immediately or after a delay. When calling signal is applied, Awaiting Answer Indication is applied to the held traffic channel and an EEM containing State of Destination - Free (SOD-F) is sent to the held extension's PBX.

2.3.1.9 On receipt of an EEM containing SOD-F, the held extension's PBX reconnects the traffic channel and removes holding indication. The call then behaves as a Simple Call awaiting answer.

3 COMPLIANCE SHEET FOR SUPPLEMENTARY SERVICE: HOLD

The Hold Supplementary Service is an optional part of DPNSS 1 and its provision on a PBX is a matter for negotiation between a customer and his supplier (see FOREWORD in SECTION 0 of this specification). This Subsection may be used as an aid to those negotiations.

NOTE: Whilst the provision of this service is optional, if it is provided, compliance with certain features of the service becomes mandatory.

Compliance with the service is considered in terms of the function(s) to be performed by the PBX ie Transit, End or Branching and the extent to which operators or extensions on the PBX can request the service.

The options available are given in TABLE 1. This table should be completed by a manufacturer to indicate PBX capability and by a purchaser to indicate PBX requirements.

TABLES 2 to 4 indicate the features that are required/provided at each PBX. The pre-printed "YES" indicates that the feature is a mandatory part of the service for that PBX function.

TABLE 1

PBX FUNCTION		APPLICABLE TABLE
PBX with operators or extensions, some of which can request the service		TABLES 2 & 3
PBX with operators or extensions none of which can request the service		TABLE 2
Transit PBX		TABLE 4

TABLE 2

COMPLIANCE TABLE FOR A PBX WITH OPERATORS OR EXTENSIONS IN A NETWORK THAT SUPPORTS HOLD		
SERVICE VARIANT		COMMENT
Able to put an extension on Hold on receipt of a Hold Request from another DPNSS 1 PBX?	YES	
Able to reconnect an extension which is on Hold on receipt of a Reconnected Indication from another DPNSS 1 PBX?	YES	
Able to reconnect an extension which is on Hold on receipt of an indication that the Holding party has cleared and is being re-rung?	YES	

TABLE 3

ADDITIONAL COMPLIANCE TABLE FOR A PBX WITH OPERATORS OR EXTENSIONS THAT ARE ABLE TO REQUEST HOLD		
SERVICE VARIANT		COMMENT
Able to request that the other party in a call be placed on Hold?	YES	
Able to indicate to the other party that it has been reconnected?	YES	
Able to re-ring the holding extension if it clears?	YES	

TABLE 4

COMPLIANCE TABLE FOR A TRANSIT PBX IN A NETWORK THAT SUPPORTS HOLD		
SERVICE VARIANT		COMMENT
Able to transit: - Hold Request, - Reconnection Indication, - Holding Party Cleared Indication?	YES	Inherent DPNSS 1 capability

DIGITAL PRIVATE NETWORK SIGNALLING SYSTEM NO 1 (DPNSS 1)

SECTION 13 - SUPPLEMENTARY SERVICE : THREE-PARTY

CONTENTS

1	GENERAL	Page 3
2	THREE-PARTY SERVICE WITHIN DPNSS 1	Page 4
2.1	DEFINITION	Page 4
2.2	DESCRIPTION	Page 4
2.3	OUTLINE OF OPERATION	Page 7
2.3.1	Enquiry Using a New Path	Page 10
2.3.2	Enquiry Using an Existing Path	Page 12
2.3.3	Call Termination after Enquiry Using a New Path	Page 15
2.3.4	Call Termination after Enquiry Using an Existing Path	Page 16
2.3.5	Shuttle after Enquiry Using a New Path ...	Page 19
2.3.6	Shuttle after Enquiry Using an Existing Path	Page 20
2.3.7	Transfer after Enquiry Using a New Path ..	Page 22
2.3.8	Transfer after Enquiry Using an Existing path	Page 24
2.3.9	Add-On after Enquiry Using a New Path	Page 27
2.3.10	Add-On after Enquiry Using an Existing path	Page 30
2.3.11	Cleardown after Add-On	Page 33
2.3.12	Clear Conference	Page 35
2.3.13	Split Using Separate Paths	Page 37
2.3.14	Split Using a Shared Path	Page 39
2.3.15	Interactions within the Service	Page 42
3	COMPLIANCE	Page 45

HISTORY

Issue 1 - February 1984
Issue 2 - September 1984
Issue 3 - March 1986
Issue 4 - December 1989

Issue 5 - March 2001 - Specification renamed as DPNSS[188]

1 GENERAL

1.1 This Section details the signalling requirements of DPNSS 1 for the Three-Party Supplementary Service.

1.2 Subsection 2 details the service within DPNSS 1.

1.3 Subsection 3 shows the Compliance.

1.4 The description is given in the form of Message Sequence Diagrams (MSDs) followed by explanatory text.

1.5 The text is referenced from MSDs at appropriate points in the sequences.

1.6 Message contents for successful calls are shown in MSDs. Messages and their contents for alternative sequences (eg for unsuccessful calls) are detailed in the text.

1.7 Coding of the contents of messages is given in SECTION 4.

1.8 **IT IS STRONGLY RECOMMENDED THAT THIS SUPPLEMENTARY SERVICE IS IMPLEMENTED IN CONJUNCTION WITH THE HOLD SUPPLEMENTARY SERVICE (SECTION 12).**

2 THREE-PARTY SERVICE WITHIN DPNSS 1.

2.1 DEFINITION

The Three-Party Supplementary Service permits an extension user, whilst holding an existing call, to make a call to a third party. The following possibilities are then available:

- i. Ability to switch between the two calls, with secrecy between them (Shuttle);
- ii. Connection of the other two parties (Transfer);
- iii. Introduction of a common speech path between the three parties (Add-On third party).

2.2 DESCRIPTION

This Supplementary Service permits a user who has placed an existing call into a suspended state (held) to make an Enquiry Call to a third party. The controlling party may then make use of any of the following service options:

- i. Shuttle. The connection is switched so that the controlling party is connected to the party who was on hold, and the party to whom the controlling party was connected is placed on hold. By repeated use of this option the controlling party may speak to each of the other two parties alternately. The party to whom the controlling party is currently connected is known as the connected party. Before the first Shuttle, the enquired-to party is the connected party;
- ii. Transfer. A connection is established between the two non-controlling parties and the controlling extension is released;
- iii. Add-On. The three parties are connected together to form a three-party conference.

The Hold Supplementary Service (SECTION 12), when used in conjunction with this Supplementary Service, may prevent a call being placed on hold by both parties at the same time. However, it is still possible for both parties in a call to have an Enquiry Call, but one must Shuttle back before the other can Enquire or Shuttle away.

Following Add-On, any of the three parties may place the conference on hold and make an Enquiry Call to a fourth party. The controller of the Enquiry Call may use Shuttle, to switch from the fourth party back to the conference, and vice-versa.

Use of the Hold Supplementary Service (SECTION 12) permits the placing of restrictions on more than one party holding a conference at the same time, in order to avoid any confusion

to users. For example, the two non-controlling parties could be prevented from holding simultaneously, whilst allowing the controlling party and one non-controlling party to hold simultaneously. This would allow the controlling party to hold at any time, and also allow a non-controlling party to make an Enquiry Call or Shuttle to an existing Enquiry Call.

This service does not permit the use of Transfer or Add-On to introduce a fourth party to a conference. Where a conference of more than three parties is required the Add-On Conference Service (SECTION 29) should be used.

The controlling party may Split a three-party conference so that it reverts to a two-party call with the third party held.

If one party of a three-party conference clears, the call reverts to a simple two-party call.

As an option a party may request clear-down of the entire conference.

Channel optimisation is possible on Enquiry Calls. If all or part of the path used by the Held Call is along the best available route for the Enquiry Call and if Single-Channel Working is supported by the PBXs concerned, the Enquiry Call may share that path. This reduces the transmission channel traffic and call-blocking probability. However, any part of the path already in dual use as a result of an Enquiry Call by one party shall not be used for an Enquiry Call by the other party.

A PBX at which the Enquiry Call ceases to share the existing path is known as the Branching PBX. If an entirely new path is used (none of the existing path is shared) the controlling party's PBX (Controlling PBX) will be the Branching PBX (see Figure A). Figure B shows the case of the Enquiry Call sharing some of the existing path before branching on to a new path at a Transit. If the Enquiry Call shares the existing path as far as the enquired-to party's PBX, then that PBX will be the Branching PBX (see Figure C).

When Add-On occurs, the three parties are connected together at the Branching PBX, which becomes known as the Conference PBX. In Single Channel Working a subsequent Enquiry Call may share all or part of the existing path to the Conference PBX if it follows the best available route for the Enquiry Call. It must not, however, share either of the existing paths beyond the Conference PBX, since these are required to maintain conversation between the two remaining parties.

When Transfer occurs, the path from the Controlling PBX to the Branching PBX is cleared, and the remaining channels are connected together at the Branching PBX (see Figure D).

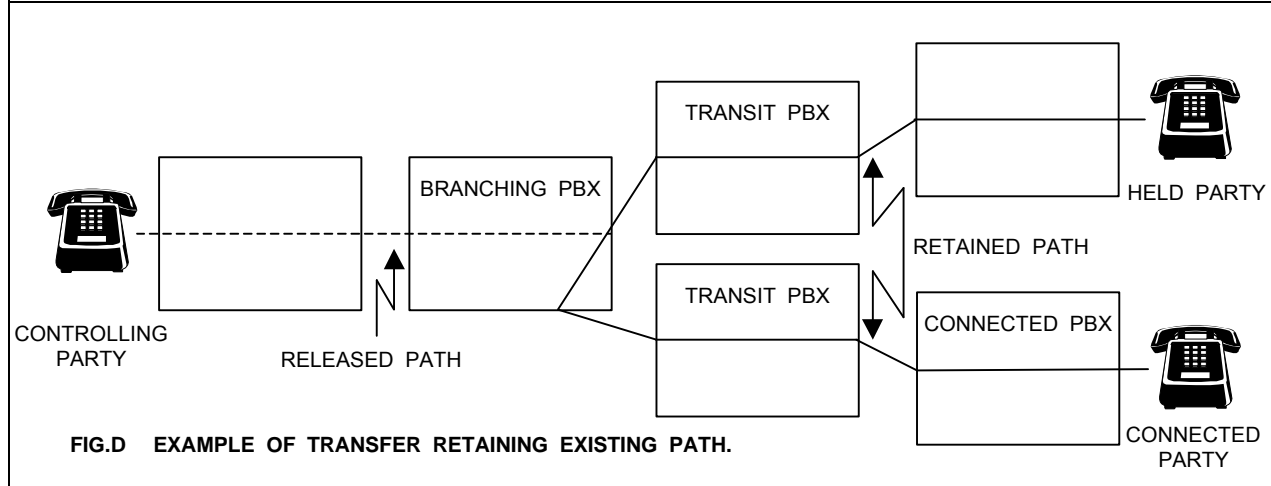
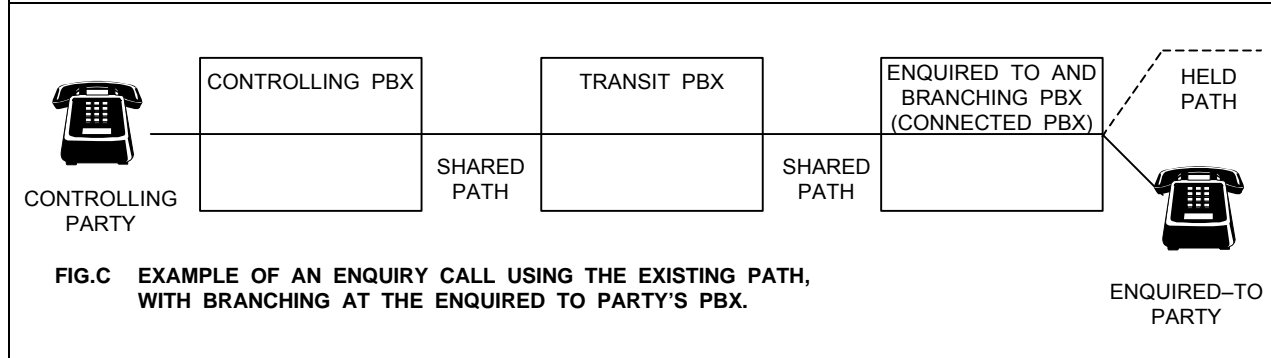
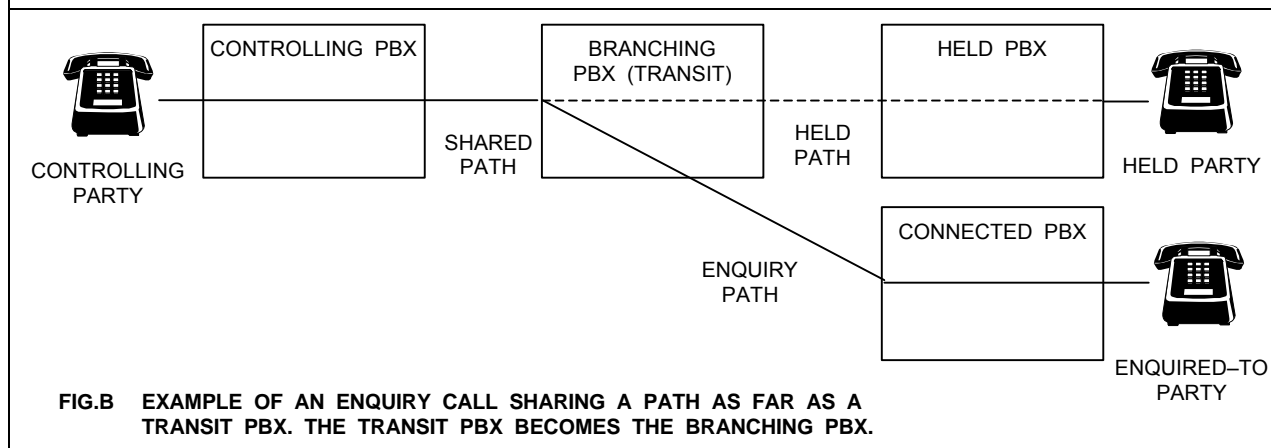
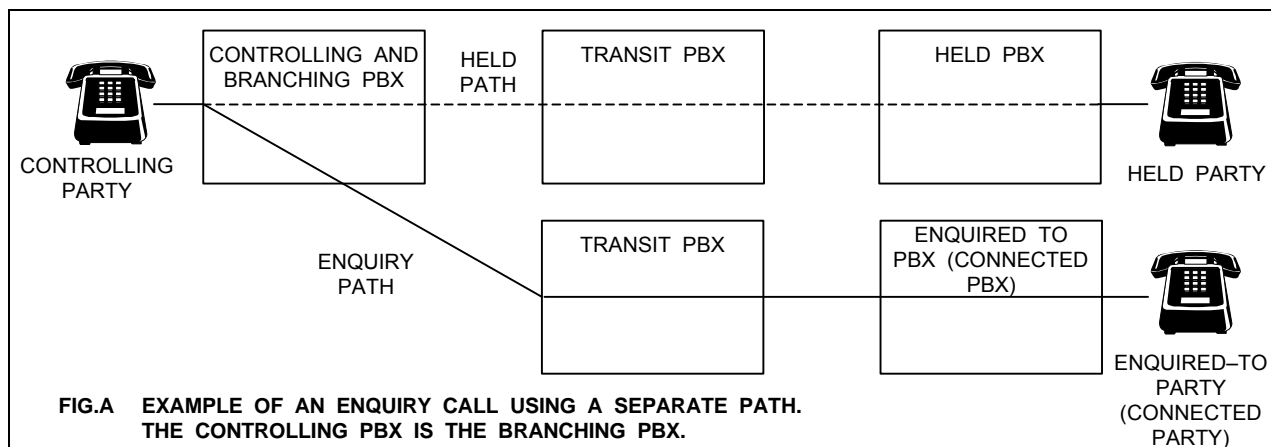

2.3 OUTLINE OF OPERATION

IT IS STRONGLY RECOMMENDED THAT THIS SUPPLEMENTARY SERVICE IS IMPLEMENTED IN CONJUNCTION WITH THE HOLD SUPPLEMENTARY SERVICE (SECTION 12).

The facilities of this Supplementary Service are provided by means of separate signalling sequences which are described in relation to a number of Message Sequence Diagrams.

The signalling sequences described are based on the following two configurations:

- i. where the Enquiry call has been made over a new path (Separate-Channel Working) as per Figure A, and
- ii. where the Enquiry Call has been made by sharing some of the path of the original call (Single-Channel Working) as per Figure B.

The sequences for the other two Separate-Channel Working configurations [ie where either the held or connected party is located at the Controlling (Branching) PBX] can be derived from those described as follows:

- where the held party is on the Controlling PBX, the signalling shown between the Controlling and Held PBXs is not applicable, but the other signalling is the same.
- where the connected party is on the Controlling PBX, the signalling shown between the Controlling and Connected PBXs is not applicable, but the other signalling is the same.

The sequences for the other three Single-Channel Working configurations (ie where the held party, the connected party, or both the held and connected parties are located at the Branching PBX) can be derived from those described as follows:

- where the held party is on the Branching PBX, the signalling shown between the Branching PBX and the Held PBX is not applicable, but the other signalling is the same.
- where the connected party is on the Branching PBX (as in Figure C), the signalling shown between the Branching PBX and the Connected PBX is not applicable, but the other signalling is the same.
- where both the connected and held parties are on the Branching PBX, neither the signalling shown between the Branching and Connected PBXs nor that shown between the Branching and Held PBXs is applicable but that between the Controlling and Branching PBXs is the same.

The sequences described are as follows:

2.3.1 Three-Party Service - Enquiry Using a New Path.

This sequence is used when a party attempts Enquiry and the Enquiry Call is unable to share any of the existing path either because the route of the Enquiry Call is not along any of the existing path or because Single-Channel Working is not available. The controlling party's PBX is the Branching PBX. This is known as Separate-Channel Working.

2.3.2 Three-Party Service - Enquiry Using the Existing Path.

This sequence is used when a party attempts Enquiry and the Enquiry Call can share some of the existing path. The Controlling PBX is not the Branching PBX. This is known as Single-Channel Working.

2.3.3 Three-Party Service - Call Termination After Enquiry Using a New Path.

This sequence is used if either the Connected Call or the Held Call is terminated (Separate-Channel Working).

2.3.4 Three-Party Service - Call Termination After Enquiry Using an Existing Path.

This sequence is used if either the Connected Call or the Held Call is terminated (Single Channel Working).

2.3.5 Three-Party Service - Shuttle After Enquiry Using a New Path.

This sequence is used if the controlling party, who is located at the Branching PBX, requests Shuttle from one party to the other.

2.3.6 Three-Party Service - Shuttle After Enquiry Using an Existing Path.

This sequence is used if the controlling party, who is not located at the Branching PBX, requests Shuttle from one party to the other.

2.3.7 Three-Party Service - Transfer After Enquiry Using a New Path.

This sequence is used if the controlling party, located at the Branching PBX, requests Transfer.

2.3.8 Three-Party Service - Transfer After Enquiry Using an Existing Path.

This sequence is used if the controlling party, not located at the Branching PBX, requests Transfer.

2.3.9 Three-Party Service - Add-On After Enquiry Using a New Path.

This sequence is used if the controlling party, located at the Branching PBX, requests Add-On.

2.3.10 Three-Party Service - Add-On After Enquiry Using an Existing Path.

This sequence is used if the controlling party, not located at the Branching PBX, requests Add-On.

2.3.11 Three-Party Service - Cleardown After Add-On.

This sequence is used if any of the three parties clears.

2.3.12 Three-Party Service - Clear Conference

This sequence is used if a party requests cleardown of the entire conference.

2.3.13 Three-Party Service - Split by a Party at the Conference PBX.

This sequence is used if a party at the Conference PBX of a three-party conference requests splitting.

2.3.14 Three-Party Service - Split by a Party not at the Conference PBX.

This sequence is used if a party not at the Conference PBX of a three-party conference requests splitting.

The above sequences are detailed in paragraphs 2.3.1 to 2.3.14 inclusive. These paragraphs contain references to the use of signalling procedures defined for the Hold Supplementary Service (SECTION 12). If that service is not supported, these procedures are omitted.

2.3.1 THREE-PARTY SERVICE - ENQUIRY USING A NEW PATH

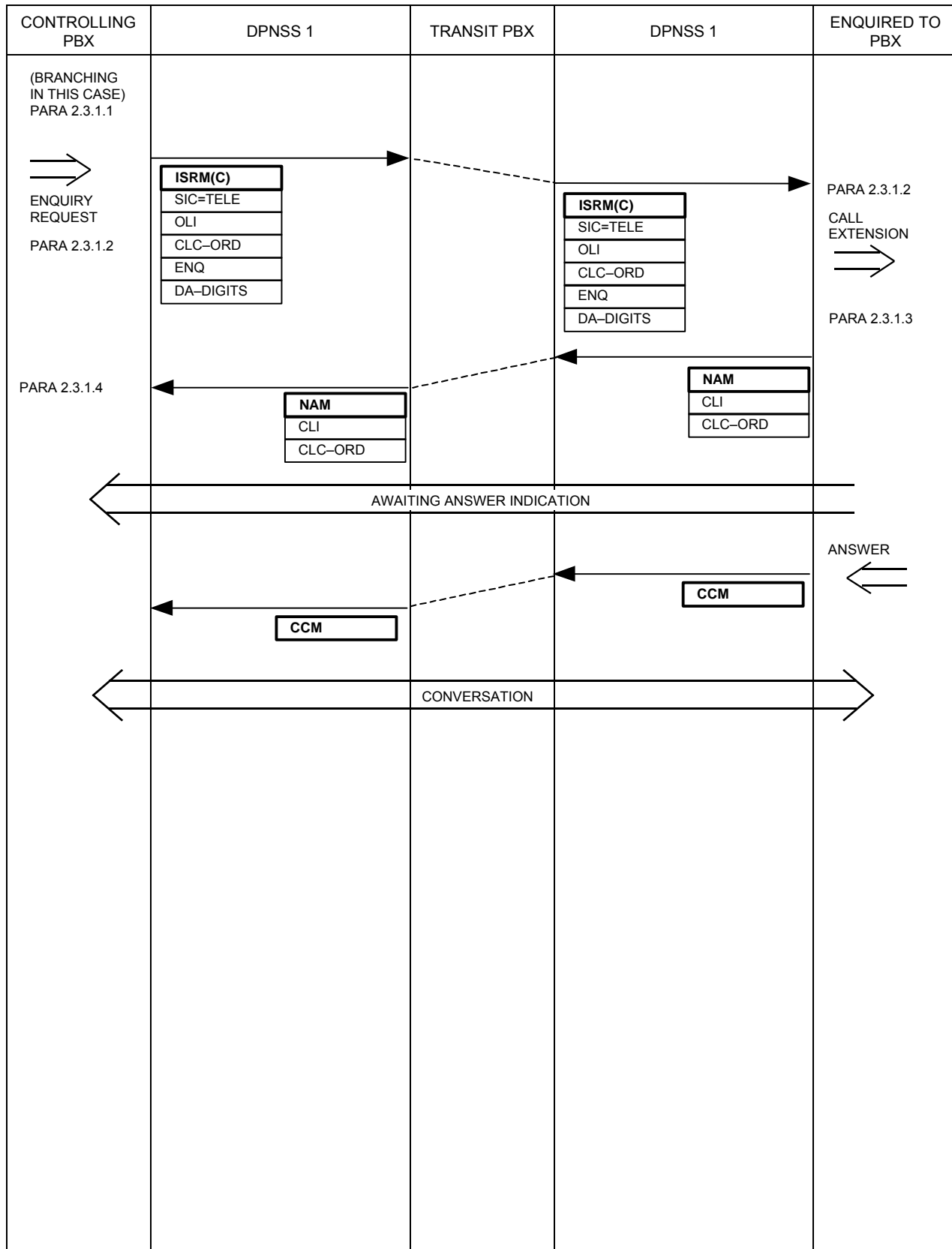

2.3.1.1 Either party of a two-party call may make an Enquiry Call, thus becoming the controlling party of the resultant three-party situation. Before making an Enquiry Call, the existing call must be placed on hold. This is done either as a result of a separate request by the user before the Enquiry Request, or as part of the Enquiry Request itself. The hold procedure defined for the Hold Supplementary Service (SECTION 12) may be used, and if rejection occurs the Enquiry Request must be rejected.

2.3.1.2 On receipt of an Enquiry Request, when the existing call has been placed on hold, the Enquiry Call is initiated. The Enquiry Call may require a new path out of the Controlling PBX for one of the following reasons:

- i. The existing path is not on the best available route.
- ii. The existing path is already in dual use as a result of an Enquiry Call by the other party.
- iii. Single-Channel Working is not supported.

In general, Simple Call procedures are followed:

A new path shall be selected and an ISRM (Complete or Incomplete) containing Enquiry (ENQ) sent. The Enquiry String contains the held party's category as a Parameter. The controlling party's traffic channel shall be connected to the new outgoing traffic channel.

The Controlling PBX is the Branching PBX.

2.3.1.3 On receipt of a ISRM containing ENQ, if the Destination Address identifies a user extension, the action taken at the Enquiry Call's Terminating PBX shall be the same as for a Simple Call, except that the ENQ String may be used to give a special calling signal.

2.3.1.4 The Controlling PBX shall receive a NAM if the Enquiry Request was accepted.

If the Enquiry Request is rejected for any reason, a CRM containing the appropriate Clearing Cause will be received. The Controlling PBX shall respond with a CIM, disconnect the controlling party's traffic channel, and give an appropriate indication.

2.3.2 THREE-PARTY SERVICE - ENQUIRY USING AN EXISTING PATH

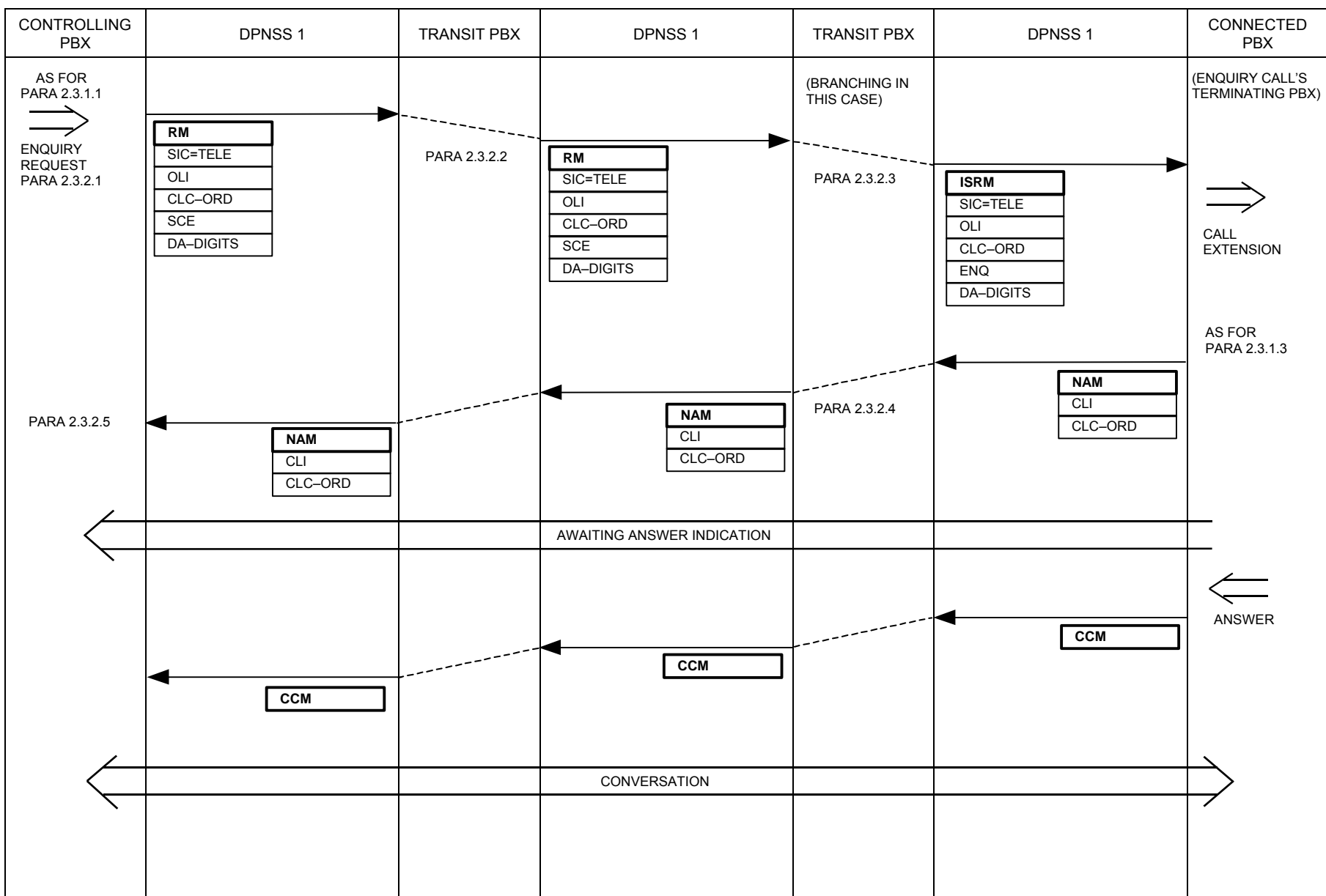

2.3.2.1 On receipt of an Enquiry Request, when the other party has been placed on hold, if the Enquiry Call is able to use the existing path out of the Controlling PBX an RM containing Single Channel Enquiry (SCE) shall be sent with the held party's category as a Parameter.

The controlling party shall be reconnected to the outgoing traffic channel. The Enquiry Call must not share the existing path where it is already in dual use as a result of an Enquiry Call by the held party.

2.3.2.2 If an existing Transit PBX receives an RM containing SCE, the Enquiry Call shall continue to share the existing path only if the Destination Address indicates that the same route can be followed and the path is not already in dual use. If the existing path can be shared an RM containing SCE shall be passed on and the PBX shall act as a Transit PBX for the Enquiry Call.

2.3.2.3 On receipt of an RM containing SCE, a PBX will become the Branching PBX in any of the following circumstances:

- i. The existing call terminates at that PBX (ie the Held PBX);
- ii. The Destination Address indicates that the Enquiry Call is to be terminated at that PBX;
- iii. The Destination Address indicates that an outgoing DPNSS 1 route different from the existing route is required;
- iv. The existing path is already in dual use as a result of an Enquiry Call by the held party.

In the case of i, iii and iv, a new outgoing path shall be selected and an ISRM containing ENQ sent along the new signalling channel. The shared traffic channel shall be disconnected from the held party's traffic channel and connected to the new traffic channel.

If there is no suitable path available, the Enquiry Call Request shall be rejected by sending an RRM with the Rejection Cause: Congestion (CON).

In the case of ii, the Enquiry Call will be handled internally by the Branching PBX (see Figure C) and no outgoing channel will be selected. A NAM or RRM shall be returned as appropriate to the SOD of the enquired-to party.

2.3.2.4 The Branching PBX shall pass the NAM on towards the Controlling PBX. Any subsequent EEMs, LLMs, SMs or CCMs relating to the Enquiry (Connected) Call shall include the COC string when passing between the Branching PBX and the Controlling PBX, in accordance with SECTION 5, paragraph 3.4.5. The Branching PBX shall be responsible for inserting or removing the COC string. EEMs, LLMs, SMs or CCMs relating to the Held Call shall pass through the Branching PBX unchanged.

If the Branching PBX receives a CRM indicating rejection of the Enquiry Call, it shall respond with a CIM and send an RRM towards the Controlling PBX. The original traffic connection shall be restored.

2.3.2.5 Receipt of a NAM shall denote successful establishment of the Enquiry Call.

If the Controlling PBX receives an RRM, it shall disconnect the traffic channel and give an appropriate indication to the controlling party. The controlling party may be reconnected to the Held Call, either on request or as a result of clearing, using the procedures defined for the Hold Supplementary Service (SECTION 12).

2.3.3 THREE PARTY SERVICE - CALL TERMINATION AFTER ENQUIRY USING A NEW PATH

2.3.3.1 Either the controlling party or the connected party may clear the enquiry call at any time. The clearing sequence shall be as for a Simple Call (see SECTION 6).

Following termination of the Connected Call, the controlling party may be reconnected to the Held Call (using, where supported, the procedures defined for the Hold Supplementary Service in SECTION 12). For this reconnection to take place the controlling party may be connected directly or may need to be re-rung.

After reconnection, the call between the controlling party and the held party shall become a simple two-party call.

2.3.3.2 Either the controlling party or the held party may clear the Held Call at any time. The clearing sequence shall be as for a Simple Call (SECTION 6).

Following termination of the Held Call, the Connected Call shall become a simple two-party call.

2.3.4 THREE-PARTY SERVICE – CALL TERMINATION AFTER ENQUIRY USING AN EXISTING PATH

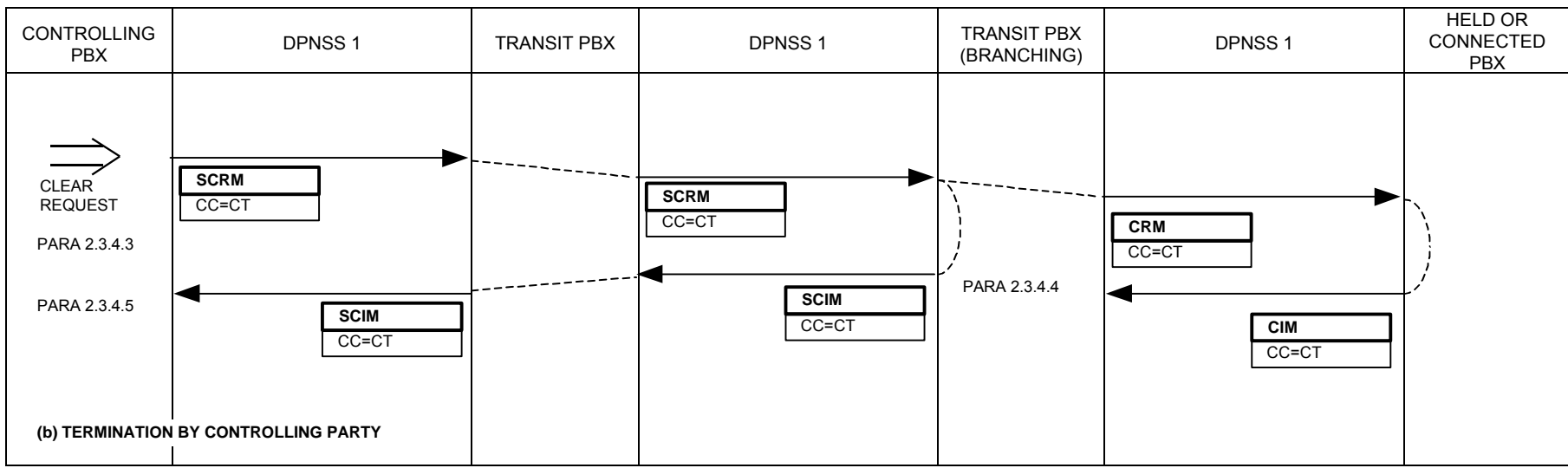
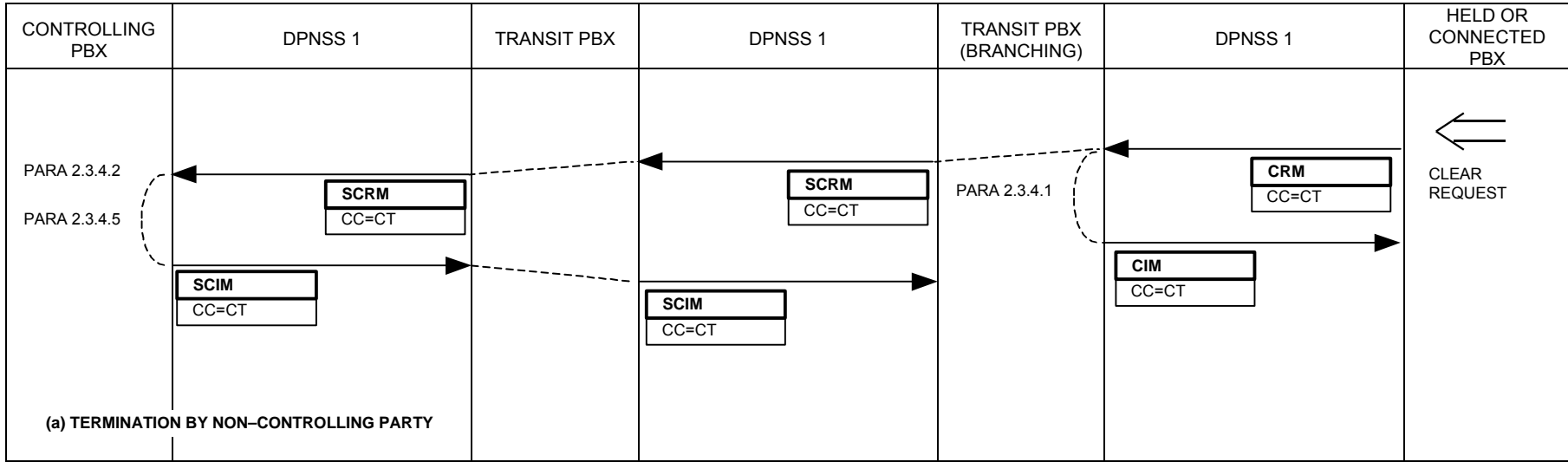

2.3.4.1 Either the held party or the connected party may clear their own call at any time. The Branching PBX will receive a CRM with the appropriate Clearing Cause, and shall respond with a CIM.

If the Routing Phase of the Enquiry Call is complete, the Branching PBX shall initiate the Shared Channel Release Sequence (SECTION 5, paragraph 3.4.7). The Branching PBX shall send a SCRM, with the same content as received in the CRM, to the Controlling PBX and shall expect a SCIM in response. String COC shall be included in the SCRM if the Connected Call is being released.

If the Held Call is cleared during the Routing Phase of the Enquiry Call, the Branching PBX shall wait until that phase is complete. If the Routing Phase is successfully completed, the Branching PBX shall initiate the Shared Channel Release Sequence. If the Enquiry Call is rejected, the Branching PBX shall release the entire call by sending a CRM, and shall expect a CIM in response.

If the Enquiry Call is cleared during the Routing Phase, this indicates rejection of the Enquiry Call (see paragraph 2.3.2.4).

2.3.4.2 On receipt of an SCRM, the Controlling PBX shall return an SCIM as an acknowledgement. If it is the Connected Call that has cleared, the controlling party's traffic channel shall be disconnected and an appropriate indication given. The controlling party may be reconnected to the Held Call, either on request or as a result of clearing, using the procedures defined for the Hold Supplementary Service (SECTION 12). If it is the Held Call that has cleared, the controlling party shall remain connected and may be given an appropriate indication.

2.3.4.3 The controlling party may request clearing of either the Held or the Connected Call at any time.

If the Routing Phase of the Enquiry Call is complete, or the Enquiry Call is released during the Routing Phase, the Controlling PBX shall initiate the Shared Channel Release Sequence (SECTION 5, paragraph 3.4.7). The Controlling PBX shall send a SCRM to the Branching PBX and shall expect a SCIM in response. String COC shall be included in the SCRM if the Connected Call is being released.

If the controlling party requests clearing of the Held Call during the Routing Phase of the Enquiry Call, the Controlling PBX shall wait until that phase is complete. If the Routing Phase is successfully completed, the Controlling PBX shall initiate the Shared Channel Release Sequence. If the Enquiry Call is rejected, the Controlling PBX shall release the entire call by sending a CRM and shall expect a CIM in response.

2.3.4.4 On receipt of an SCRM the Branching PBX shall respond with an SCIM. A CRM shall be sent along the unwanted path and a CIM expected in response. The two remaining traffic channels shall be connected together and the Branching PBX shall revert to a Transit PBX for the remaining call.

2.3.4.5 Following termination of the Connected Call, the controlling party may be reconnected to the Held Call (using, where supported, the procedures defined for the Hold Supplementary Service in SECTION 12). For this reconnection to take place the controlling party may need to be re-rung or may be connected directly.

After termination of the Held Call, or after termination of the Connected Call and reconnection of the controlling party to the Held Call, the remaining call shall become a simple two-party call.

2.3.4.6 Normal call termination procedures, as detailed in the foregoing paragraphs, do not involve the use of CRMs and CIMs on a path in dual use. However, if a CRM is received it shall be treated as follows:

- i. The Controlling PBX shall return a CIM and indicate to the controlling party that both calls have cleared;
- ii. When the Branching PBX receives a CRM from the shared path, it shall respond with a CIM. It shall pass the CRM along both the held channel and the connected channel and expect a CIM from each in response.

2.3.5 THREE-PARTY SERVICE - SHUTTLE AFTER ENQUIRY USING A NEW PATH.

There is no signalling specific to the Three Party service in this case since all the processing required to perform Shuttle takes place internally to the Controlling PBX. However, signalling may arise as a consequence of using the Hold Supplementary Service.

2.3.5.1 Before performing Shuttle, the Connected Call must be placed on hold. This is done either as a result of a separate request by the user before the Shuttle Request, or as part of the Shuttle Request itself. The hold procedure defined for Hold Supplementary Service (SECTION 12) may be used and, if rejection occurs, the Shuttle Request must be rejected. A Hold or Shuttle Request before the Enquiry Call is answered shall be rejected.

2.3.5.2 When the Controlling PBX has received the Shuttle Request and has placed the Connected Call on hold, it shall switch the two calls. The Controlling PBX shall then treat the Connected Call as the Held Call and vice-versa. The controlling party may be reconnected to the NEW Connected Call using the procedure defined for the Hold Supplementary Service (SECTION 12).

2.3.6 THREE-PARTY SERVICE – SHUTTLE AFTER ENQUIRY USING AN EXISTING PATH

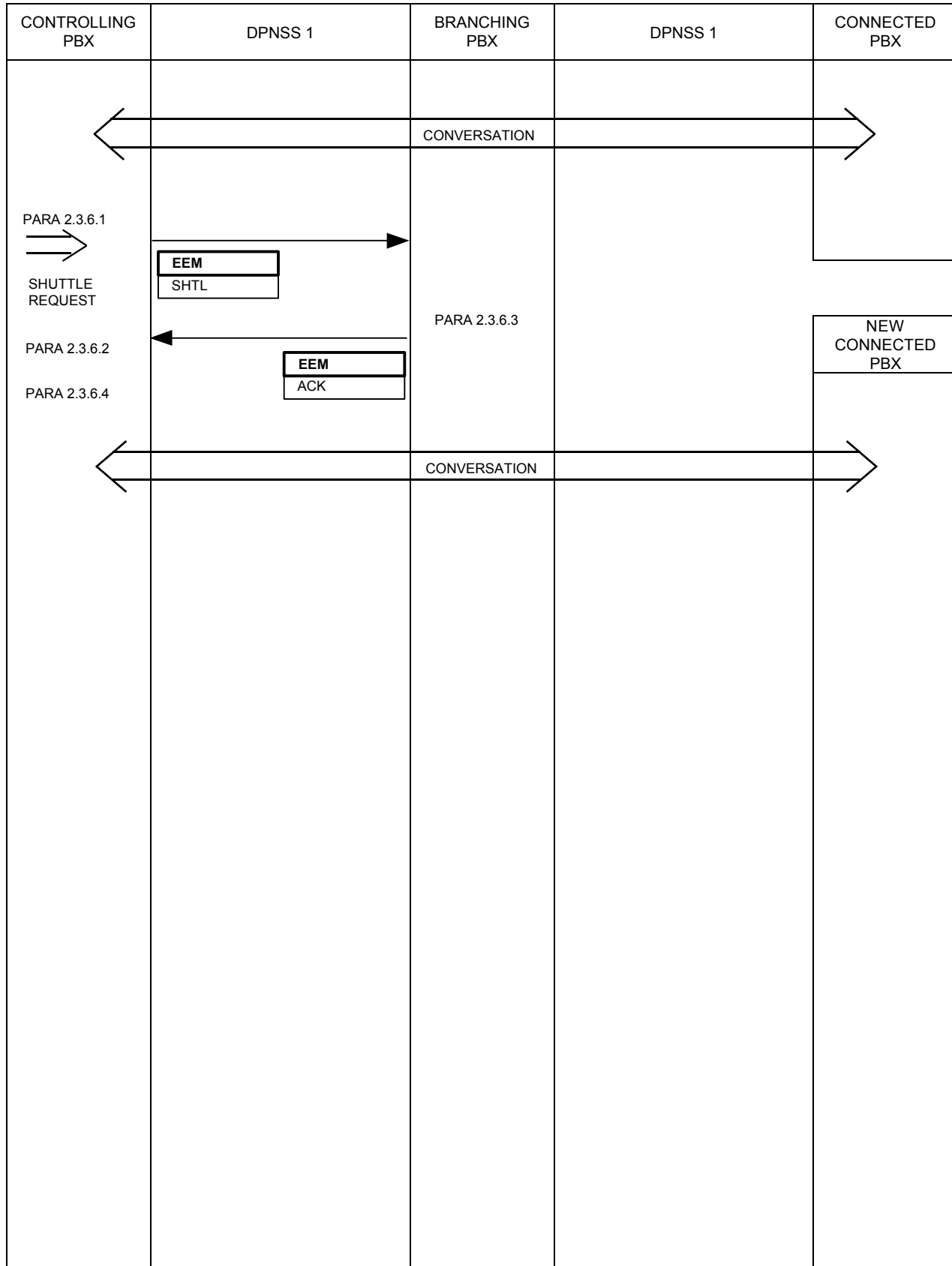

2.3.6.1 Before performing Shuttle, the Connected Call must be placed on hold. This is done either as a result of a separate request by the user before the Shuttle Request, or as part of the Shuttle Request itself. The hold procedure defined for the Hold Supplementary Service (SECTION 12) may be used and, if rejection occurs, the Shuttle Request must be rejected. A Hold or Shuttle Request before the Enquiry Call is answered shall be rejected.

2.3.6.2 When the Controlling PBX has received the Shuttle Request and has placed the Connected Call on hold, it shall send an EEM containing Shuttle (SHTL) to the Branching PBX. No further EEMs, LLMs, CCMs, SMs or SCRMs shall be sent until an acknowledgement has been received.

2.3.6.3 When the Branching PBX has received an EEM, containing SHTL, it shall switch the two calls. The shared traffic channel shall be disconnected from the connected traffic channel and connected to the held traffic channel, and an EEM containing ACK shall be returned to the Controlling PBX. The Branching PBX shall then treat the Connected Call as the Held Call and vice-versa. The presence of the COC String in subsequent EEMs, LLMs, CCMs, SMs and SCRMs (sent and received) shall denote the NEW Connected Call.

2.3.6.4 When the Controlling PBX receives an EEM containing ACK, it shall treat the Connected Call as the Held Call and vice-versa. The presence of the COC String in subsequent EEMs, LLMs, CCMs, SMs and SCRMs (sent and received) shall denote the NEW Connected Call. The controlling party may be reconnected to the NEW Connected Call using the procedure defined for the Hold Supplementary Service (SECTION 12).

Any EEM, LLM, SM or CCM received before the acknowledgement shall refer, if the COC String is present, to the OLD Connected Call, or, if the COC String is absent, to the OLD Held call.

If an SCRm is received before the acknowledgement, it shall be treated as if the EEM containing SHTL had not been sent. The EEM containing SHTL will have been ignored.

If neither an EEM containing ACK nor an SCRm is received within 5 s, the Controlling PBX shall clear both calls, by sending a CRM containing Clearing Cause: NT, as the state of the Controlling and Branching PBXs will be inconsistent. A CIM shall be expected in response.

2.3.7 THREE-PARTY SERVICE – TRANSFER AFTER ENQUIRY USING A NEW PATH

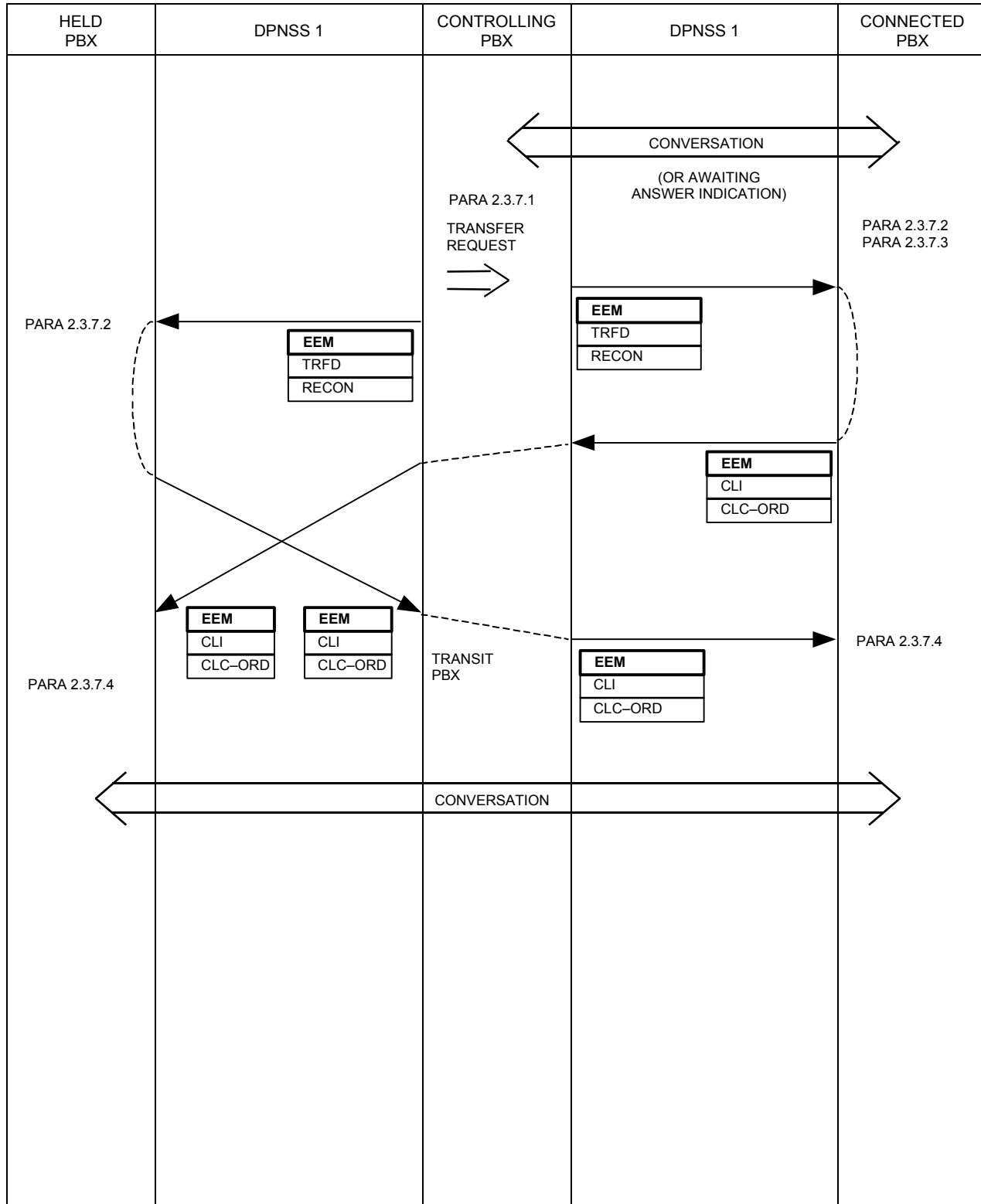

2.3.7.1 If the controlling party makes a Transfer Request, the Controlling PBX shall examine the CLCs of the other two parties to ensure that transfer is allowed. Some designs of PBX may reject a Transfer Request if the Enquiry Call has not been answered.

The Controlling PBX shall connect the two traffic channels of the non controlling parties together and become a Transit PBX for the resulting two-party call. An EEM containing TRFD and RECON shall be sent to both the Held PBX and the Connected PBX. The Parameter of String TRFD shall be used to nominate one of the remaining parties as the originating party and the other as the terminating party.

A controlling party in a Three-Party call shall not be able to invoke transfer other than to attempt to transfer together the two non-controlling parties (ie a controlling party may not transfer control of a Three-Party Call to a fourth party).

2.3.7.2 Each of the remaining PBXs on receipt of an EEM containing TRFD and RECON shall send an EEM containing its party's CLC and CLI to the other PBX. If a party is currently held, following the use of the Hold Supplementary Service by the controlling party, holding indication shall be removed and the party reconnected to the traffic channel.

The presence of String RECON in the received EEM ensures that the party shall be reconnected even if the String TRFD is not understood. This situation can arise if the PBX supports the Hold Service but not the Three-Party Service.

2.3.7.3 If transfer occurs before the Enquiry Call is answered the Connected PBX shall include String SOD-F in the EEM it sends to the Held PBX, and leave Awaiting Answer Indication connected to the traffic channel. When Answer occurs, it shall send a CCM to the Held PBX.

Note that if Answer occurs at the same time as transfer, it is possible for the CCM to cross on the link with the EEM containing TRFD. Since the Controlling PBX will have become a simple Transit PBX by the time it receives the CCM, it will pass the CCM on towards the Held PBX. The Held PBX shall ignore the CCM.

2.3.7.4 On receipt of an EEM containing the other party's CLC and CLI, this information may be stored and/or indicated to the user.

2.3.8 THREE-PARTY SERVICE – TRANSFER AFTER ENQUIRY USING AN EXISTING PATH

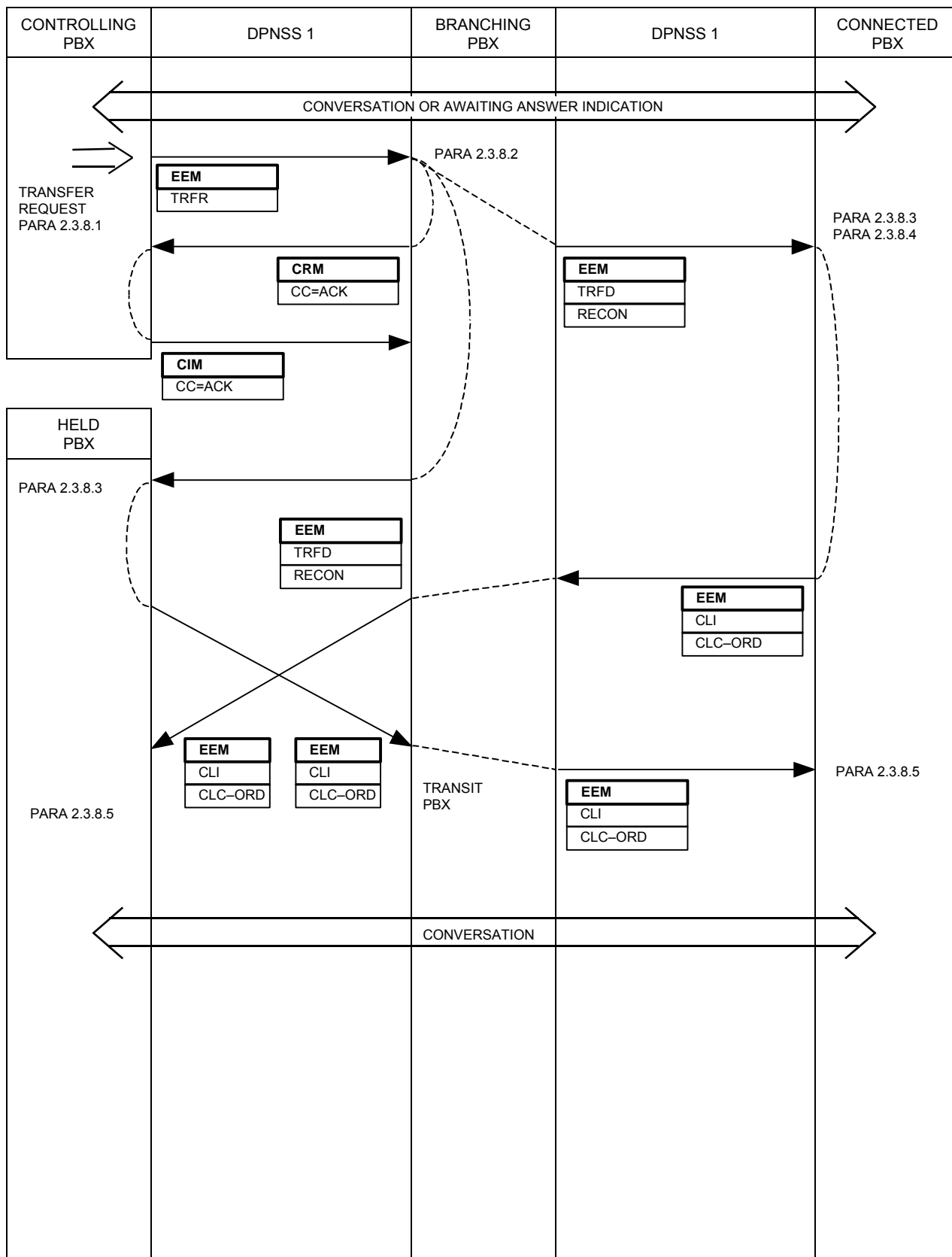

2.3.8.1 If the controlling party makes a Transfer Request, the Controlling PBX shall examine the CLCs of the other two parties to ensure that transfer is allowed. If so an EEM containing Transfer Request (TRFR) shall be sent and a CRM containing the Clearing Cause: ACK shall be expected in response. Some designs of PBX may reject a Transfer Request if the Enquiry Call has not been answered.

A controlling party in a Three-Party Call shall not be able to invoke transfer other than to attempt to transfer together the two non-controlling parties (ie a controlling party may not transfer control of a Three-Party call to a fourth party).

After sending an EEM containing TRFR and while awaiting an ACK or an EEM containing REJ, any other EEM received shall be saved. If a CRM is subsequently received, the EEMs shall be discarded. If an EEM containing REJ is subsequently received, the previous EEM shall be acted upon.

2.3.8.2 When the Branching PBX receives an EEM with String TRFR from the Controlling PBX, and is able to transfer, it shall respond with a CRM containing Clearing Cause: ACK. It shall connect the other two traffic channels together and become a Transit PBX for the resulting two-party call. An EEM containing TRFD and RECON shall be sent to both the Held PBX and the Connected PBX. The Parameter of String TRFD shall be used to nominate one of the remaining parties as the originating party and the other as the terminating party.

If the transfer is rejected by the Branching PBX an EEM containing REJ shall be sent to the Controlling PBX where appropriate action shall be taken, for example the controlling extension may be re-rung.

2.3.8.3 Each of the remaining PBXs, on receipt of an EEM containing TRFD and RECON, shall send an EEM containing its party's CLC and CLI to the other. If a party is currently held, following the use of the Hold Supplementary Service by the controlling party, holding indication shall be removed and the party shall be reconnected to the traffic channel.

The presence of String RECON in the received EEM shall ensure that the party is reconnected even if the String TRFD is not understood. This situation can arise if the PBX supports the Hold Service but not the Three-Party Service.

2.3.8.4 If transfer occurs before the Enquiry Call is answered, the Connected PBX shall include String SOD-F in the EEM it sends to the Held PBX, and shall leave Awaiting Answer Indication connected to the traffic channel. When Answer occurs, it shall send a CCM to the Held PBX.

Note that if Answer occurs at the same time as transfer, it is possible for the CCM to cross on the link with the EEM containing TRFD. Since the Branching PBX will have become a simple Transit PBX by the time it receives the CCM, it will pass the CCM on towards the Held PBX. The Held PBX shall ignore the CCM.

2.3.8.5 On receipt of an EEM containing the other party's CLC and CLI, this information may be stored and/or indicated to the user.

2.3.9 THREE-PARTY SERVICE – ADD-ON AFTER ENQUIRY USING A NEW PATH

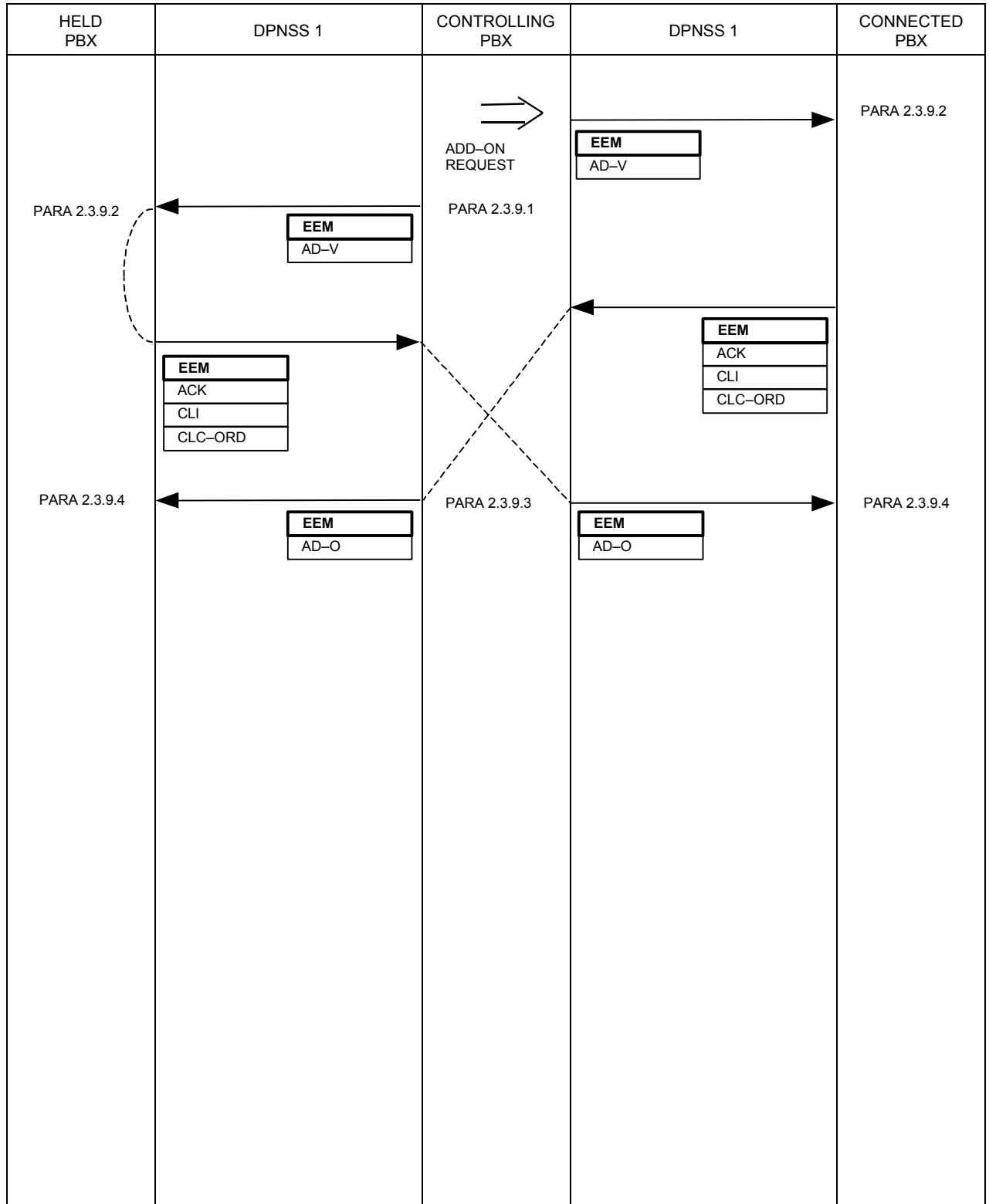

2.3.9.1 After the Enquiry Call has been answered the controlling party may make an Add-On Request. The Controlling PBX shall send an EEM containing Add-On Validation (AD-V) to each of the non-controlling parties' PBXs.

2.3.9.2 On receipt of an EEM containing AD-V, a non-controlling party's PBX shall check whether the party is allowed to be connected in conference and if so shall return an EEM containing ACK together with the party's identity and category (CLI and CLC).

If Add-On is not permitted, an EEM containing REJ shall be returned.

2.3.9.3 When the Controlling PBX has received an EEM from each of the two non-controlling parties' PBXs, if both EEMs contain ACK, the non-controlling parties' categories shall be checked to ensure that they are allowed to be connected in the same conference. If so, the two traffic channels shall be connected in conference with the controlling party. An indication may be given to the controlling party.

An EEM containing Added-On (AD-O) is sent to each of the non-controlling parties' PBXs. The Controlling PBX shall become the Conference PBX and store the identities and categories of the three parties.

If the Controlling PBX receives an EEM containing SNU, indicating non-support of Three-Party Service, it may still go ahead with Add-On although it will not know the identity or category of the party concerned and will be unable to check its compatibility with the other parties. Since an EEM containing AD-O would not be understood, an EEM containing RECON shall be sent instead to that party to ensure its removal from hold, if it has been placed on hold by the controlling party.

If either of the received EEMs contains REJ, or if the parties are not allowed to be connected together, or the Controlling PBX does not receive both responses within 5 s, the Add-On shall be aborted and an appropriate indication may be given to the controlling party.

If a CRM is received from one of the non-controlling parties, a CIM shall be sent in response and the Add-On shall be aborted.

2.3.9.4 On receipt of an EEM containing AD-O, a non-controlling party's PBX may give an indication to that party.

Any of the three parties may make an Enquiry Call. This may share all or part of the existing path from the enquiring party's PBX to the Conference PBX. If the call is routed as far as the Conference PBX and does not terminate there, it must be routed via a new channel from the Conference PBX.

Shuttle between an Enquiry Call and the conference is permitted, but any Transfer or Add-On Request shall be rejected. The sequences for Enquiry Calls described in paragraphs 2.3.1 to 2.3.5 also apply to Enquiry after Add-On, except that the Conference PBX shall act as the Held PBX (or the Connected PBX after Shuttle).

The Parameter of String ENQ in an ISRM or of SCE in an RM shall be set to indicate "Conference".

2.3.10 THREE-PARTY SERVICE – ADD-ON AFTER ENQUIRY USING AN EXISTING PATH

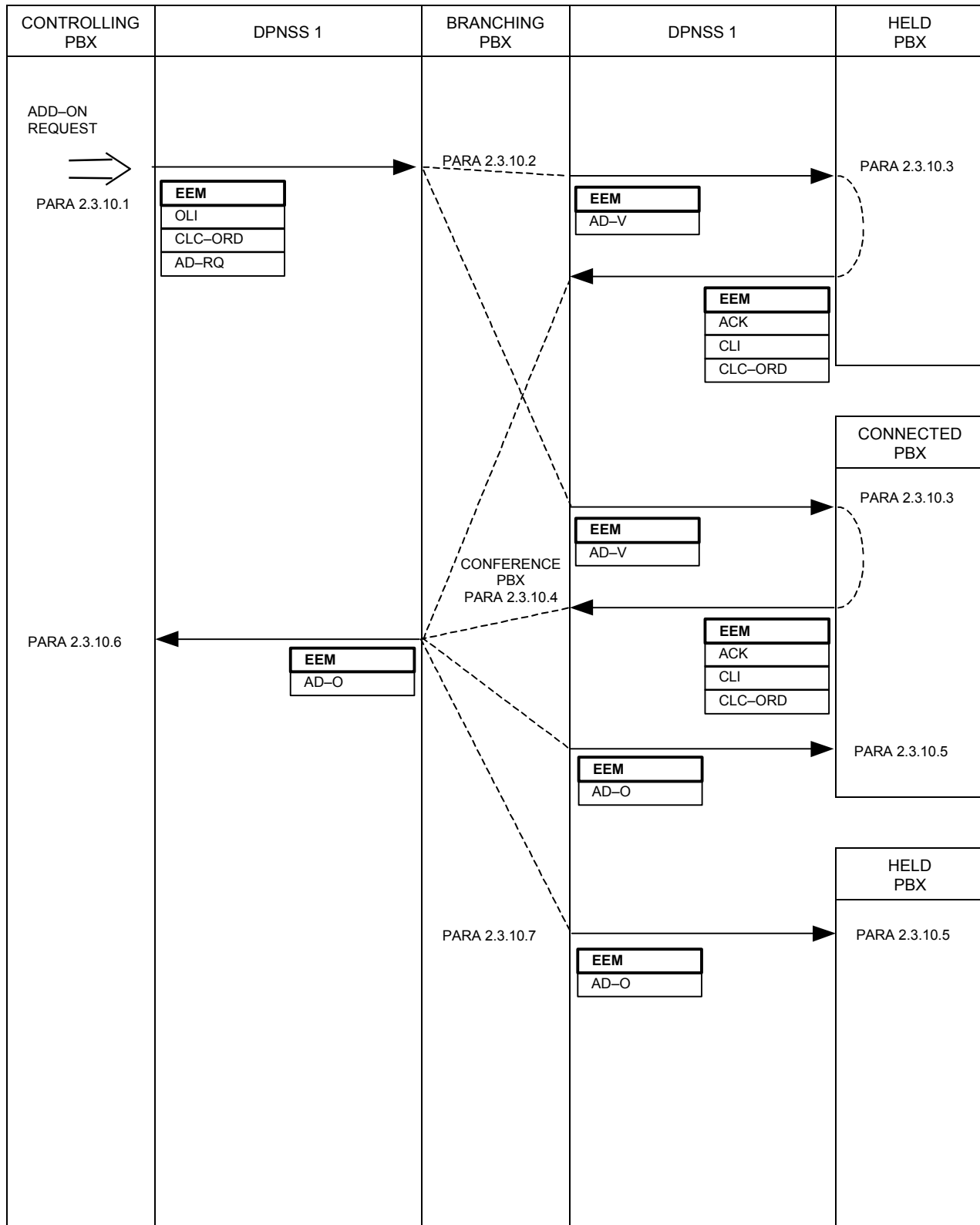

2.3.10.1 After the Enquiry Call has been answered the controlling party may make an Add-On Request. An EEM containing Add-On Request (AD-RQ) and the controlling party's identity and category (OLI and CLC) shall be sent to the Branching PBX. Having sent the EEM containing AD-RQ, the Controlling PBX must not act upon or send any further EEMs, LLMs, SMS, SCRMs or CCMs until a response has been received. Any received EEMs (other than those that contain an expected response to AD-RQ), LLMs, SMS, SCRMs or CCMs, shall be saved and acted upon only following completion of the signalling related to AD-RQ.

2.3.10.2 On receipt of an EEM containing AD-RQ, the Branching PBX shall send out an EEM containing Add-On Validation (AD-V) to each of the non-controlling parties' PBXs.

2.3.10.3 On receipt of an EEM containing AD-V, a non-controlling party's PBX shall check whether the party is allowed to be connected in conference and if so shall return an EEM containing ACK together with the party's identity and category (CLI and CLC).

If Add-On is not permitted, an EEM containing REJ shall be returned.

2.3.10.4 When the Branching PBX has received an EEM from each of the two non-controlling parties' PBXs, if both EEMs contain ACK, the non-controlling parties' categories shall be checked to ensure that they are allowed to be connected in the same conference. If so, all three traffic channels shall be connected in conference.

An EEM containing Added-On (AD-O) shall be sent to each of the non-controlling parties' PBXs and to the Controlling PBX. The Branching PBX shall become the Conference PBX and store the identities and categories of the three parties.

If the Branching PBX receives an EEM containing SNU, indicating non-support of Three-Party Service, it may still go ahead with Add-On although it will not know the identity or category of the party concerned and will be unable to check its compatibility with the other parties. Since an EEM containing AD-O would not be understood, an EEM containing RECON shall be sent instead to that party, to ensure its removal from hold, if it has been placed on hold by the controlling party.

If either of the received EEMs contains REJ, or if the parties are not allowed to be connected together, the Branching PBX shall reject the Add-On Request by returning an EEM containing REJ to the Controlling PBX .

If the Branching PBX does not receive both responses within 5 s, it shall send an EEM containing REJ to the Controlling PBX.

If a CRM is received from one of the non-controlling parties, a CIM shall be sent in response. An SCRIM (containing COC in the case of the connected party) shall be sent to the Controlling PBX and an SCIM expected in response. The Add-On shall be aborted.

2.3.10.5 On receipt of an EEM containing AD-O, a non-controlling party's PBX may give an indication to that party.

2.3.10.6 On receipt of an EEM containing AD-O, the Controlling PBX may give an indication to the controlling party in addition to reconnecting the traffic channel.

On receipt of an EEM indicating failure, an appropriate indication shall be given to the controlling party.

If the Controlling PBX receives no response within 10 s it shall send a CRM containing Clearing Cause: NT and expect a CIM in response.

If the Controlling PBX receives an SCRIM it shall treat it as normal and assume that the Add-On has been cancelled.

2.3.10.7 Following Add-On, it is no longer possible to send EEMs, LLMs, SMs and CCMs between the PBXs of the parties that are conferenced together. The Conference PBX shall act as the End PBX for any EEMs, LLMs, SMs and CCMs and handle them according to the contents of the Indication Block.

Any of the three parties may make an Enquiry Call, which may use all or part of the existing path as far as the Conference PBX. The path from the Controlling PBX to the Conference PBX shall be considered to be no longer in dual use, thus permitting its use for an Enquiry Call by the controlling party. Shuttle between an Enquiry Call and the conference shall be permitted, but any Transfer or Add-On Request shall be rejected. The sequences for Enquiry Calls described in paragraphs 2.3.1 to 2.3.5 also apply to Enquiry after Add-On, except that the Conference PBX shall act as the Held PBX (or the Connected PBX after Shuttle).

The Parameter of String ENQ in an ISRM or of SCE in an RM shall be set to indicate "Conference".

2.3.11 THREE-PARTY SERVICE – CLEARDOWN AFTER ADD-ON

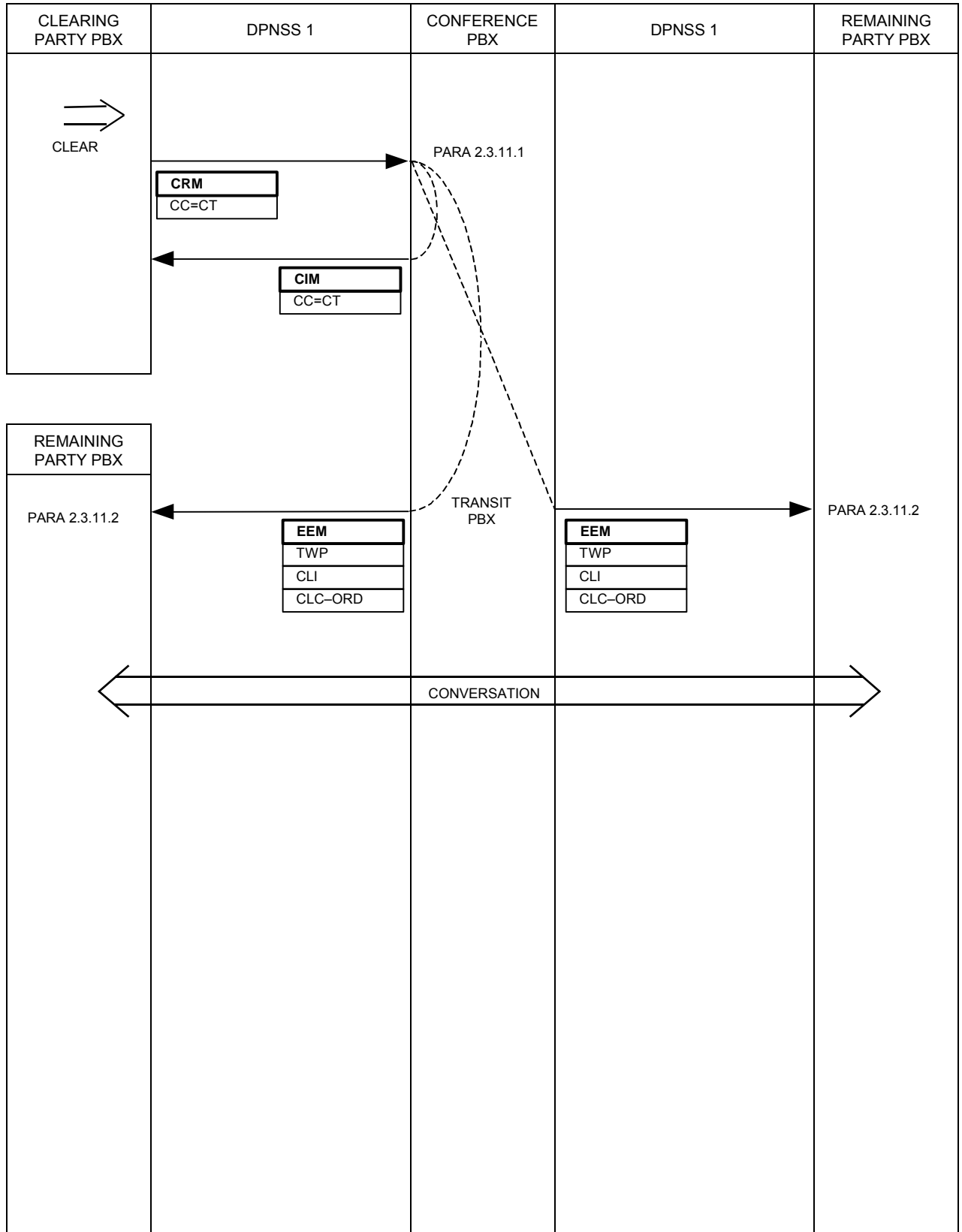

2.3.11.1 If, following Add-On, the Conference PBX receives a CRM from any of the parties, it shall return a CIM and disconnect the conference. If the clearing party is connected directly to the Conference PBX then no DPNSS 1 signalling is involved but the conference shall be disconnected. If the two remaining parties are allowed to remain connected together, they shall be reconnected and an EEM containing Two-Party (TWP) and CLC and CLI (if previously received) shall be sent on each remaining channel. The Parameter of String TWP shall be used to nominate one of the remaining parties as the originating party and the other as the terminating party of the resulting two-party call. The Conference PBX shall then behave as a normal Transit PBX.

If the two remaining parties are not allowed to remain connected together, a CRM containing the Clearing Cause: NT shall be sent along each of their signalling channels and a CIM expected in response from each.

2.3.11.2 When a remaining PBX receives an EEM containing TWP, it may give an appropriate indication to its party.

2.3.12 THREE-PARTY SERVICE – CLEAR CONFERENCE

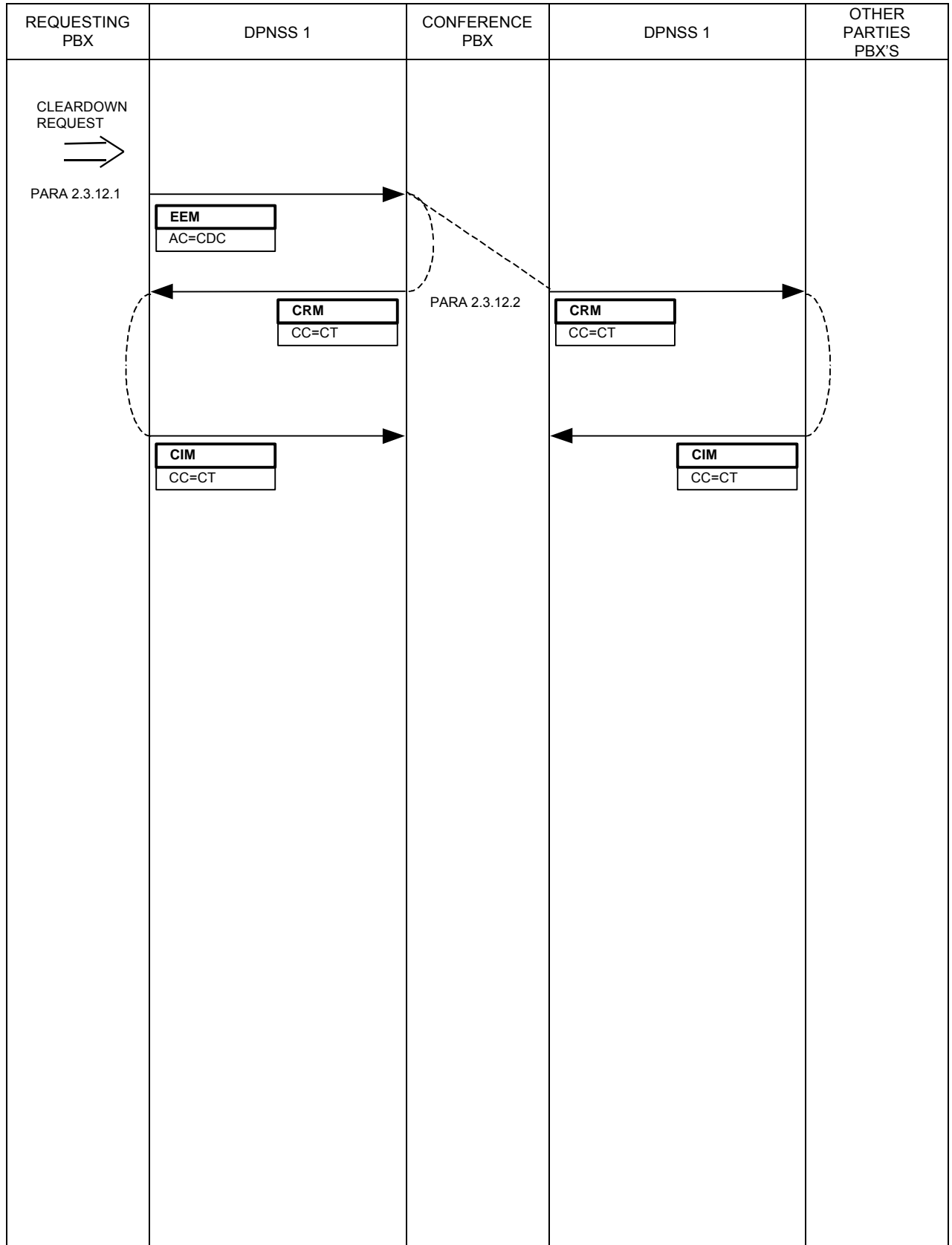

2.3.12.1 While a Three-Party Conference is in progress a party may request cleardown of the entire conference. An EEM containing the Supplementary Information String AC-CDC shall be sent from that party's PBX to the Conference PBX .

2.3.12.2 On receipt of an EEM containing AC-CDC, the Conference PBX shall disconnect all parties from the conference and shall send a CRM containing Clearing Cause: CT to each party involved in the conference. A CIM shall be expected in response from each.

If any party has an Enquiry Call, the Enquiry Call shall remain connected.

If the Enquiry Call is routed via the same channel as the Conference Call (ie a channel in dual use) then an SCRM shall be used to release the conference call. An SCIM shall be expected in response.

If the party was connected to the conference at the time (with the Enquiry Call on hold), String COC shall be included in the SCRM and SCIM.

NOTE: It is not mandatory for a PBX to support this part of the Three-Party Supplementary Service and thus the String AC-CDC may be treated as unrecognised. In such a case, an EEM containing SNU will be received at the requesting party's PBX in response to the EEM containing AC-CDC. An appropriate indication shall be given to the requesting party.

2.3.13 THREE-PARTY SERVICE – SPLIT USING SEPARATE PATHS

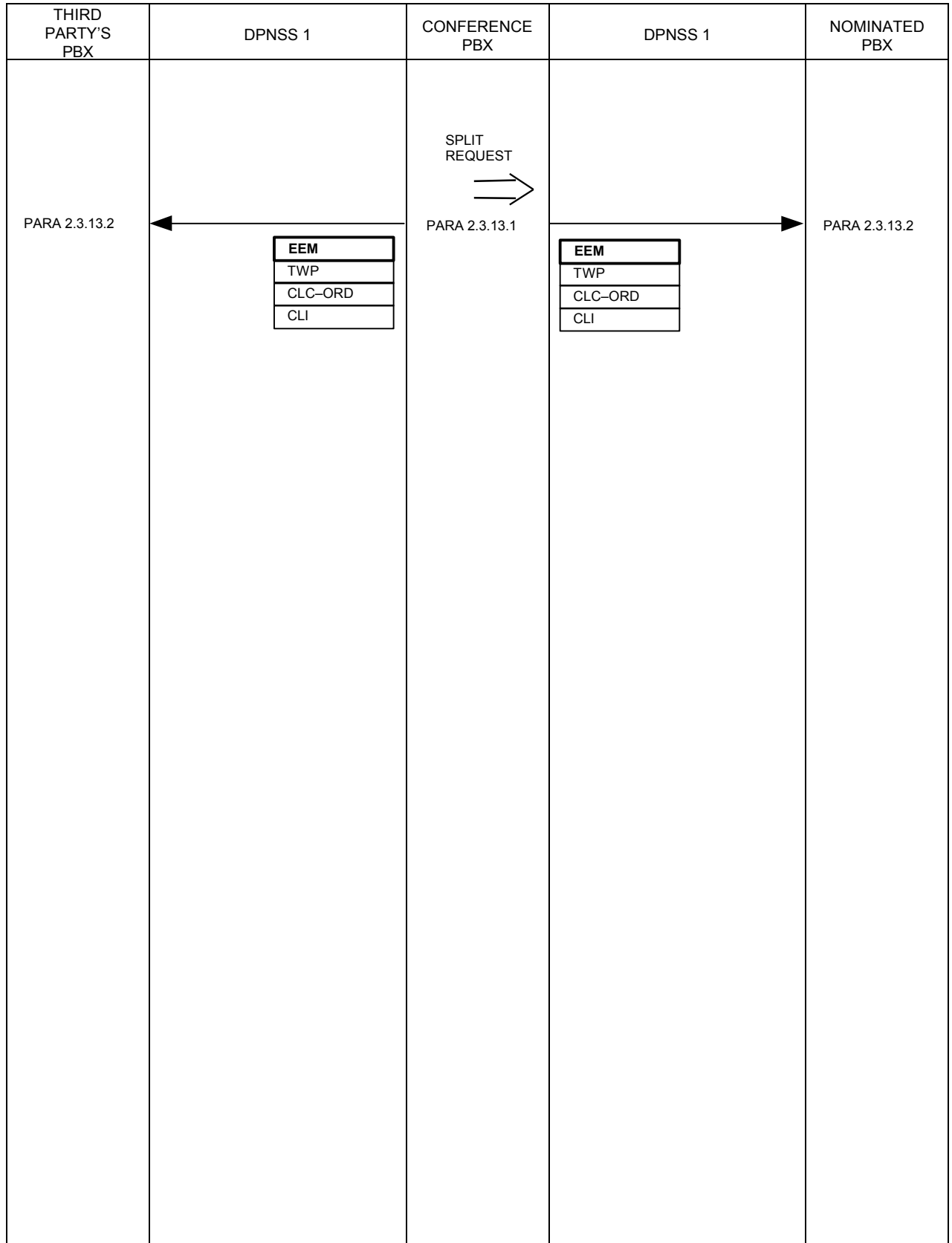

2.3.13.1 Following Add-On, any party at the Conference PBX may request Split in order to be connected to one of the other parties, the third party being placed on hold. (The procedures applicable to handling a Split Request by a party at any other PBX are covered in 2.3.14).

The Conference PBX shall disconnect the conference and connect the requesting party to the nominated party.

An EEM containing TWP (Parameter: Call Direction = T) together with the requesting party's identity and category shall be sent to each non-requesting party's PBX. The resultant call involving the requesting party and the nominated party shall be treated as an Enquiry Call for which the requesting party is the controlling party. The Conference PBX shall then behave as a Controlling PBX.

The options then available to the requesting party shall be the same as those available to a controlling party following the establishment of an Enquiry Call, ie, Shuttle, Release, Enquiry, Transfer and Add-On.

If the Hold Supplementary Service is to be used to notify the third-party's PBX that the third party is being placed on hold, the Conference PBX shall attempt to place that party on hold, using the Hold Supplementary Service procedures, before performing the Split. If, as a result, an EEM containing REJ is received from the third-party's PBX, the Split shall be abandoned.

2.3.13.2 When a non-requesting party's PBX receives an EEM containing TWP, it shall treat the call as a simple two-party call.

2.3.14 THREE-PARTY SERVICE – SPLIT USING A SHARED PATH

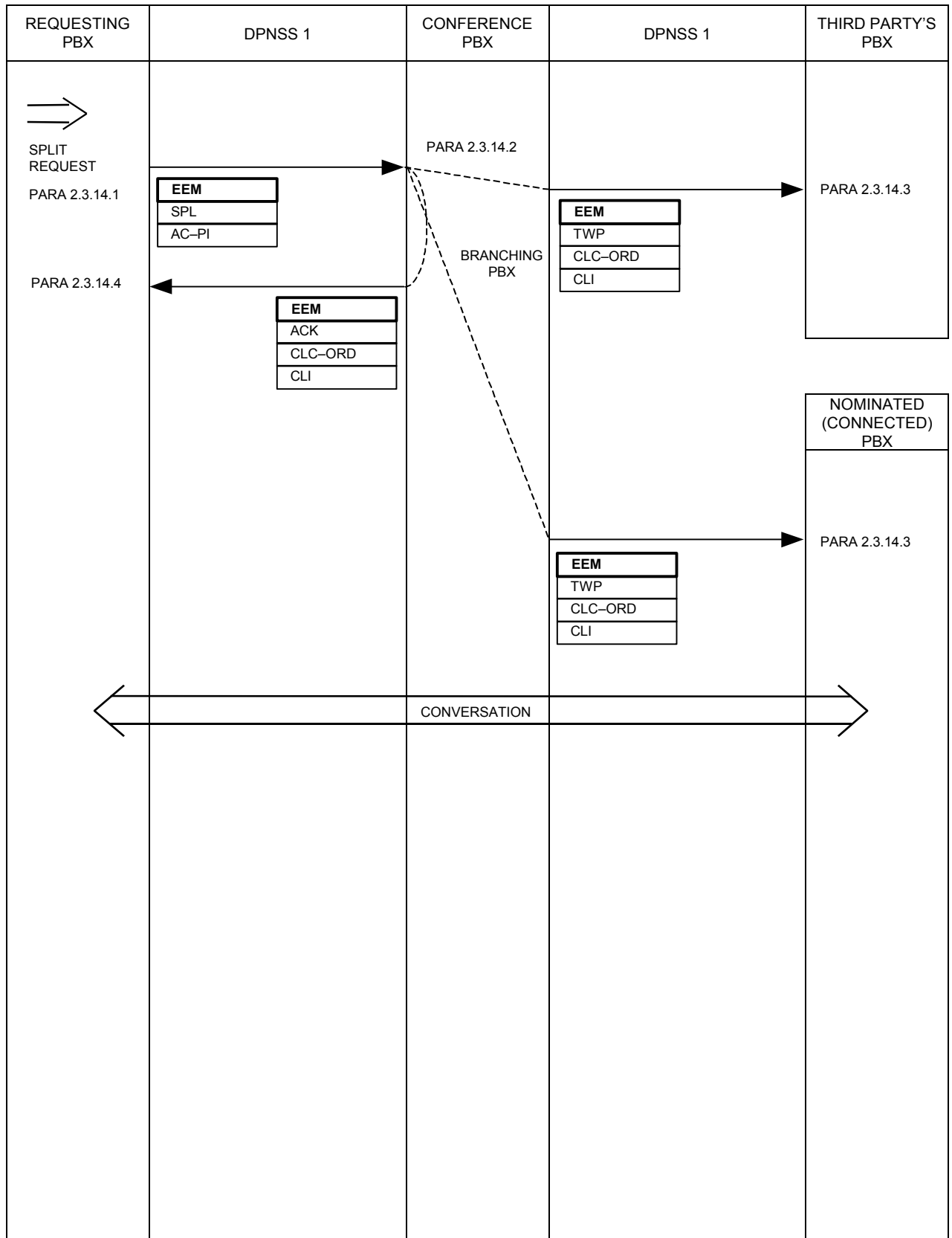

2.3.14.1 Following Add-On, any party not at the Conference PBX may request Split in order to be connected to another party, the third party being placed on hold. (The procedures applicable to handling a Split Request by a party at the Conference PBX are covered in 2.3.13). Such a request requires the support of Single-Channel Working between the Requesting PBX and the Conference PBX. If the Requesting PBX cannot support Single-Channel Working or any condition exists which precludes the dual use of the path to the Conference PBX, or if the requesting party already has an Enquiry Call, the request shall be rejected locally.

If the request is acceptable, an EEM containing Split (SPL) and Add-On Conference Party Index (AC-PI) is sent to the Conference PBX. No further EEMs shall be sent until a response has been received.

If the Hold Supplementary Service is to be used, to notify the third-party's PBX that the third party is being placed on hold, String HOLD-REQ shall be included in the EEM.

AC-PI contains the Index of the party to be connected to. When a three-party conference is formed, Index 1 shall be assigned to the party requesting Add-On, Index 2 shall be assigned to the held party and Index 3 shall be assigned to the connected party. These indices shall be retained as long as the parties remain in the conference. Note that the Add-On Conference Supplementary Service (SECTION 29) may be used to add further parties, each new party being allocated its own index (4, 5, etc.). If as a result of parties clearing, the conference reduces to three parties again, the party indices will not necessarily be 1, 2 and 3.

2.3.14.2 When the Conference PBX receives an EEM containing SPL, it shall disconnect the conference. If the String AC-PI is contained within the EEM, the traffic channels of the requesting and nominated parties shall be connected together. If the string AC-PI is not present, the traffic channel of the requesting party shall be connected to that of the party who was the controlling party, unless the requesting party was the controlling party in which case it shall be connected to the previously connected party's traffic channel.

An EEM containing TWP (Parameter: Call Direction = T) together with the requesting party's identity and category (if received previously) shall be sent to each non-requesting party's PBX, and an EEM containing ACK and the nominated extension's CLC and CLI (if received previously) shall be returned to the Requesting PBX. The resultant call involving the requesting party and the nominated party shall be treated as an Enquiry Call for which the requesting party is the controlling party. The Conference PBX shall then behave as a Branching PBX.

If the EEM containing SPL also contains HOLD-REQ the Conference PBX shall attempt to place the third party on hold, using the Hold Supplementary Service procedures, before performing the Split. If, as a result, an EEM containing REJ is received from the third-party's PBX, it shall be passed on to the Requesting PBX and the Split shall be abandoned.

If Split cannot be performed, eg because the Party Index is invalid or Single-Channel Working is not supported by the Conference PBX, the Conference PBX shall return an EEM containing SU to the Requesting PBX.

2.3.14.3 When a non-requesting party's PBX receives an EEM containing TWP, it shall treat the call as a simple two-party call.

2.3.14.4 When the Requesting PBX receives an EEM containing ACK, it shall reconnect the requesting party's traffic channel, if necessary, and may give a suitable indication to the requesting party.

The options then available to the requesting party shall be the same as those available to a controlling party following the establishment of an Enquiry Call, ie, Shuttle, Release, Enquiry, Transfer and Add-On.

If the Requesting PBX receives an EEM containing REJ or SU, it shall give a suitable indication to the requesting party.

If the Requesting PBX receives no response within 10 s it shall send a CRM containing the Clearing Cause: NT to the Conference PBX and expect a CIM in response.

2.3.15 Interactions Within The Service

It is possible for interactions internal to the Three-Party service to occur where a non controlling party in one Three-Party call is the controlling party of another. This situation is represented by the diagram below, which shows one Three-Party call involving a controlling party A, with non-controlling parties B and C and Branching PBX X, such that B is the controlling party of another Three-Party call with non-controlling parties A and D and Branching PBX Y. The PBXs to which A, B, C and D are connected are denoted by PA, PB, PC and PD, respectively.

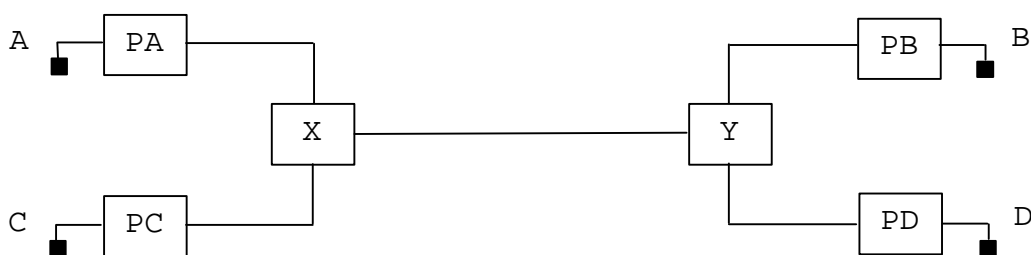

In general, the interactions which may occur, for example Add-On by a non-controlling party or simultaneous transfer by the two controlling parties, are catered for by the general signalling procedures detailed in SECTION 5 and the procedures outlined in this SECTION for the control of the various Three-Party facilities.

There are, however, two cases which require special consideration as detailed below.

2.3.15.1 Simultaneous Transfer and Add-On

A Transfer-request by any party in a conference shall be rejected locally by the PBX. That is TRFR shall not be sent, after receipt of AD-O, until further receipt of TWP. It is, however, possible for an interaction to occur if Transfer and Add-On requests are made simultaneously. Referring to the diagram, this is represented by B requesting Transfer at the same time as A requests Add-on. One of the following cases may then occur:

1. AD-O sent by X crosses with TRFD sent from Y.
2. TRFD is received by X whilst at least one of the AD-V responses is awaited.
3. TRFD sent on to PA by X crosses with AD-RQ.
4. AD-O sent from X to PB crosses with TRFR between PB and Y.

In Case 1, the Conference PBX (X) shall ignore both TRFD and the subsequent other party details sent by PD. PD, having sent D's details on receipt of TRFD from Y, will then receive AD-O whilst awaiting details of the other party involved in the transfer. Thus PD will receive AD-O without having been involved in an Add-On validation sequence. If, at the time of receipt of AD-O, PD would have rejected an EEM containing AD-V, it may clear the DPNSS 1 channel by sending a CRM containing Clearing Cause: NT. Otherwise, AD-O shall be considered as the other party details. In addition, the channel to the Conference PBX shall be considered to be in the answered state, irrespective of whether a String indicating an unanswered state, eg SOD-F, was sent with the party details.

In Case 2, TRFD shall be passed to PA in the normal manner (with or without COC added, as appropriate), and the Add-On signalling performed by the Branching PBX (X) shall also continue as normal. PA shall then behave as in Case 3. If D's details are received by X whilst still a Branching PBX, they shall be passed on to PA (with or without COC added, as appropriate). If X has become a Conference PBX by then, D's details shall be ignored by X and not passed on.

If TRFD from Y crosses with AD-V from X, then PD will receive AD-V having already responded to TRFD (from Y) with D's details. PD shall respond to AD-V as normal, and continue to expect other party details. If a conference is ultimately formed, PD will receive AD-O which it shall consider to be the other party details. If the conference request is rejected, PD will eventually receive A's details from PA.

If TRFD from Y does not cross with AD-V from X (because the validation sequence between X and PB completed before TRFD was sent by Y) then PD will not be involved in the validation sequence at all. In the event of a conference being formed, PD will receive AD-O and shall behave as in Case 1. If the conference is not formed, PD will be unaware of the conference attempt and will receive A's details as normal for the case where Transfer into an Enquiry Call has occurred.

In Case 3, PA shall not respond to TRFD until a response to AD-RQ has been received. If the response is AD-O, then it shall not respond at all since the other party in the transfer (D) will also have received AD-O and considered it as the other party details. If the response is REJ, then it shall treat TRFD as normal by responding with A's details and awaiting D's details if these have not yet arrived. All other PBXs shall behave as in Case 2.

In Case 4, PBX Y shall note that AD-O has been received and passed on to PB and shall use this to reject the Transfer Request from PB. All subsequent Transfer Requests shall be handled in the same manner until such time as TWP, caused by the breakdown of A's conference, is passed from X to PB. PB shall handle receipt of AD-O in the normal manner and may anticipate receipt of REJ as the response it is awaiting to having sent TRFR.

2.3.15.2 Simultaneous Add-Ons

A single call shall not involve more than one Conference PBX. Thus referring to the diagram, it is not permissible for both A and B to form separate conferences. Except where adding further parties into an existing conference (see SECTION 29), a conference request shall be barred locally if the requesting party is already in a conference (indicated by a previous receipt of AD-O and no subsequent receipt of TWP).

In the case where two parties try to form a conference simultaneously, then either AD-V will be received by a Conference PBX which has just sent AD-O, or AD-V will be received by a Branching PBX which is in the process of performing its own Add-On validation sequence. In the first case, the Conference PBX shall return REJ. In the second case, rather than passing AD-V onto its Controlling PBX, the Branching PBX shall respond with REJ and continue its validation process.

3 COMPLIANCE SHEET FOR SUPPLEMENTARY SERVICE: THREE PARTY

The Three-Party Supplementary Service is an optional part of DPNSS 1 and its provision on a PBX is a matter for negotiation between a customer and his supplier (see FOREWORD in SECTION 0 of this specification). This Subsection may be used as an aid to those negotiations.

NOTE: Whilst the provision of this service is optional, if it is provided, compliance with certain features of the service becomes mandatory.

Compliance with the service is considered in terms of the function(s) to be performed by the PBX, ie Transit, End or Branching, and the extent to which extensions on the PBX can request the service.

The options available are given in TABLE 1. This table should be completed by a manufacturer to indicate PBX capability and by a purchaser to indicate PBX requirements.

TABLES 2 to 8 indicate the features which are required/provided at each PBX. The pre-printed "YES" indicates that the feature is a mandatory part of the service for that PBX function.

TABLE 1

PBX FUNCTION		APPLICABLE TABLE
PBX with operators or extensions some of which can request the service		TABLES 2 & 4
PBX supporting Single-Channel Working for the service with operators or extensions some of which can request the service		TABLES 2, 3, 4 & 5
PBX with operators or extensions none of which can request the service		TABLE 2
PBX supporting Single-Channel Working for the service with operators or extensions none of which can request the service		TABLES 2 & 3
Transit PBX		TABLE 6
Transit PBX supporting Single-Channel Working for the service		TABLES 6 & 7
Transit PBX with branching capability for the service		TABLES 6, 7 & 8

TABLE 2

COMPLIANCE TABLE FOR A PBX WITH OPERATORS OR EXTENSIONS IN A NETWORK WHICH PROVIDES THE THREE-PARTY SERVICE		
SERVICE VARIANT		COMMENT
Able to accept incoming Enquiry Calls via a separate channel?	YES	
Able to accept transfer to extensions on other DPNSS 1 PBXs via a separate channel?	YES	
Able to accept being added into and split from a Three-Party Conference via a separate channel?	YES	

TABLE 3

COMPLIANCE TABLE FOR A PBX WITH OPERATORS OR EXTENSIONS IN A NETWORK WHICH PROVIDES THE THREE-PARTY SERVICE USING SINGLE-CHANNEL WORKING		
SERVICE VARIANT		COMMENT
Able to accept incoming Enquiry Calls via the same channel as the existing call?	YES	
Able to respond correctly to a Shuttle Command via a shared channel?	YES	
Able to accept transfer to extensions on other DPNSS 1 PBXs via a channel that is shared with the Held Call?	YES	
Able to respond correctly to a Transfer Command via a shared channel?	YES	
Able to accept being added into and split from a Three-Party Conference via a channel that is shared with a Held Call?	YES	
Able, as a non-controlling PBX, to establish and split a Three-Party Conference (conference bridge at a non-controlling PBX) via a shared channel?	YES	
Able as a non-controlling PBX, to request clear-down of an entire Three-Party Conference?		

TABLE 4

COMPLIANCE TABLE FOR A PBX WITH OPERATORS OR EXTENSIONS THAT ARE ABLE TO REQUEST THREE PARTY CALLS		
SERVICE VARIANT		COMMENT
Able to establish an Enquiry Call to an extension on another PBX via a separate channel?	YES	
Able, as a Controlling PBX, to control Shuttle via a separate channel?	YES	Internal PBX function
Able, as a Controlling PBX, to transfer calls to extensions on other DPNSS 1 PBXs (calls via separate channels)?	YES	
Able as a Controlling PBX to establish and release a Three-Party Conference (calls via separate channels, conference bridge at the Controlling PBX)?	YES	

TABLE 5

ADDITIONAL COMPLIANCE TABLE FOR A PBX WITH OPERATORS OR EXTENSIONS THAT ARE ABLE TO REQUEST THREE-PARTY CALLS USING SINGLE-CHANNEL WORKING		
SERVICE VARIANT		COMMENT
Able to establish an Enquiry Call to an extension on another PBX via the same channel as the existing call?	YES	
Able, as a Controlling PBX, to control Shuttle (calls via shared channels)?		
Able, as a Controlling PBX, to transfer calls to extensions on other DPNSS 1 PBXs (calls via shared channels)?	YES	
Able, as a Controlling PBX, to request that a remote PBX establishes a Three-Party Conference (conference bridge at the remote PBX)?	YES	
Able, as a Controlling PBX, to request Splitting of a conference (conference bridge at a remote PBX)?		

TABLE 6

COMPLIANCE TABLE FOR A TRANSIT PBX IN A NETWORK THAT SUPPORTS THREE-PARTY CALLS		
SERVICE VARIANT		COMMENT
Able to act as a Transit for Enquiry Calls received on a new channel?	YES	Inherent DPNSS 1 capability
Able to pass on messages relating to Transfer Notification via a separate channel?	YES	Inherent DPNSS 1 capability
Able to pass on messages relating to Add-On Validation via a separate channel?	YES	Inherent DPNSS 1 capability

TABLE 7

COMPLIANCE TABLE FOR A TRANSIT PBX IN A NETWORK THAT SUPPORTS THREE-PARTY CALLS USING SINGLE-CHANNEL WORKING		
SERVICE VARIANT		COMMENT
Able to act as a Transit for Enquiry Calls received on the same channel as the original call (non-Branching)?	YES	
Able to pass on messages relating to Shuttle?	YES	Inherent DPNSS 1 capability
Able to pass on Transfer Commands?	YES	Inherent DPNSS 1 capability
Able to pass on messages relating to Transfer Notification?	YES	Inherent DPNSS 1 capability
Able to pass on messages relating to Add-On Command?	YES	Inherent DPNSS 1 capability

TABLE 8

COMPLIANCE TABLE FOR A TRANSIT PBX IN A NETWORK THAT SUPPORTS THREE-PARTY CALLS WITH BRANCHING CAPABILITY		
SERVICE VARIANT		COMMENT
Able to act as a Transit for Enquiry Calls received on the same channel as the original call (Branching)?	YES	
Able to respond correctly to a Shuttle Command?	YES	
Able to respond correctly to a Transfer Command?	YES	
Able to establish, split and release a Three-Party Conference (conference bridge at Branching PBX)?	YES	

DIGITAL PRIVATE NETWORK SIGNALLING SYSTEM NO 1 (DPNSS 1)

SECTION 14 - SUPPLEMENTARY SERVICE : CALL OFFER

CONTENTS

1	GENERAL	Page 2
2	CALL OFFER BETWEEN ORDINARY EXTENSIONS WITHIN DPNSS 1	Page 3
	2.1 DEFINITION.....	Page 3
	2.2 DESCRIPTION.....	Page 3
	2.3 OUTLINE OF OPERATION.....	Page 3
	2.3.1 Call Offer Requested by Calling Party Accepted by Clear.....	Page 4
	Call Offer Requested by Calling Party Accepted by Hold.....	Page 5
	2.3.2 Call Offer Converted to Executive Intrusion.....	Page 8
3	COMPLIANCE	Page 10

HISTORY

Issue 1 - February 1984
Issue 2 - September 1984
Issue 3 - March 1986
Issue 4 - December 1989

Issue 5 - March 2001 - Specification renamed as DPNSS[188]

1 GENERAL

1.1 This Section details the signalling requirements of DPNSS 1 for the Call Offer Supplementary Service.

1.2 Subsection 2 details the service within DPNSS 1.

1.3 Subsection 3 shows the Compliance.

1.4 The description is given in the form of Message Sequence Diagrams (MSDs) followed by explanatory text.

1.5 The text is referenced from MSDs at appropriate points in the sequences.

1.6 Message contents for successful calls are shown in MSDs. Messages and their contents for alternative sequences (eg for unsuccessful calls) are detailed in the text.

1.7 Coding of the contents of messages is given in SECTION 4.

2 CALL OFFER BETWEEN ORDINARY EXTENSIONS WITHIN DPNSS 1

2.1 DEFINITION

The Call Offer service enables the Calling party to indicate to the wanted party, on an already established call, that another call is being offered.

As an option, the calling party may convert from offering the call to Executive Intrusion on the call.

2.2 DESCRIPTION

A user engaged on an existing call is given an indication (Call Waiting Indication) that another call is incoming to his line, whilst the calling party is given an in-channel indication that the wanted extension is receiving Call Waiting. The wanted party is then given the choice of:

- i. Clearing and being automatically re-rung;
- ii. Holding the existing call, and Answering the new call;
- iii. Rejecting the Call Waiting Indication;
- iv. Ignoring the waiting call.

The Call Offer service is a calling party service.

2.3 OUTLINE OF OPERATION

The Call Offer service is provided by the following signal sequences:

2.3.1 Call Offer Requested by Calling Party: Accepted by Clear.

Call Offer Requested by Calling Party: Accepted by Hold.

2.3.2 Call Offer: Converted to Executive Intrusion.

2.3.1 CALL OFFER REQUESTED BY CALLING PARTY ACCEPTED BY CLEAR

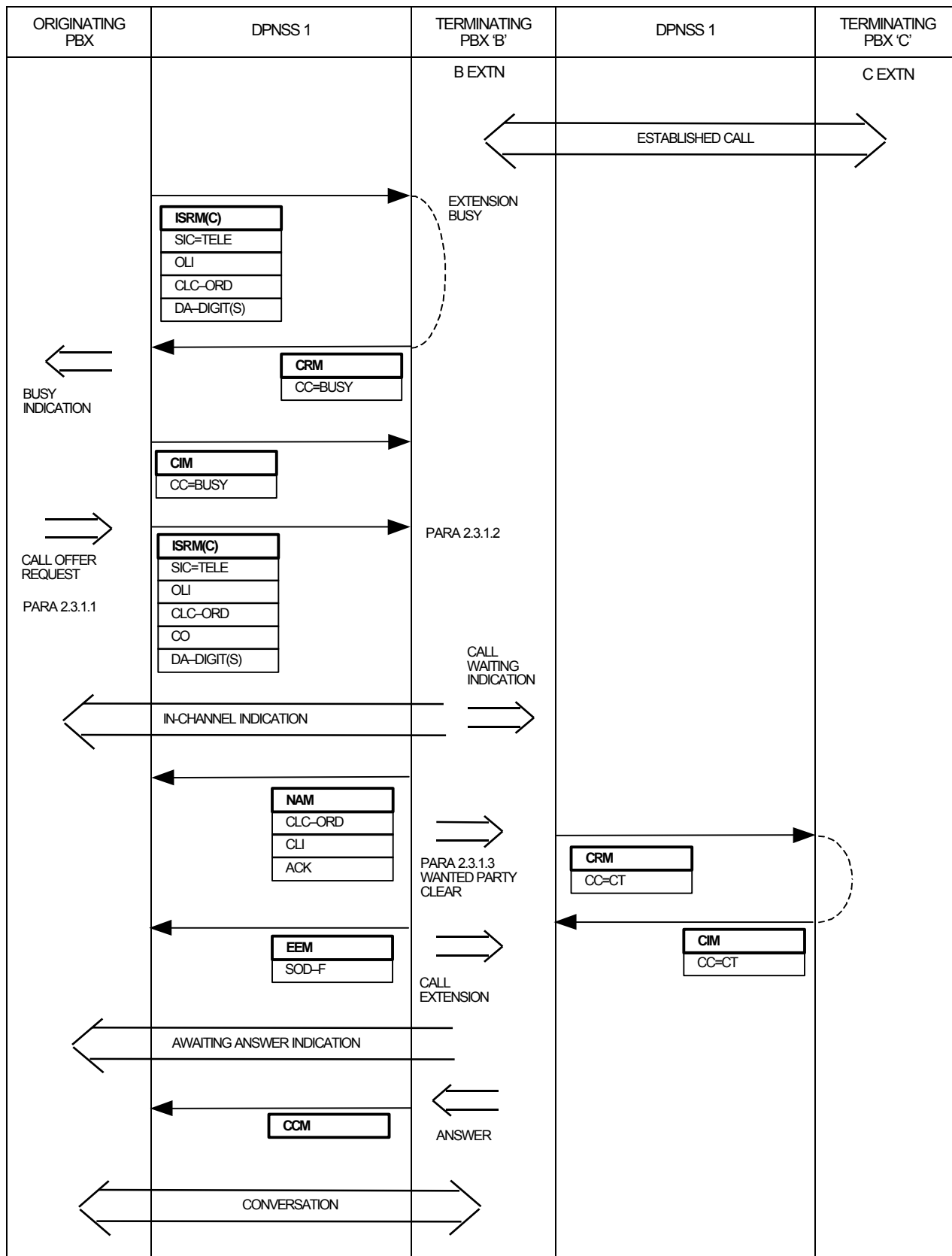

2.3.1 CALL OFFER REQUESTED BY CALLING PARTY ACCEPTED BY HOLD

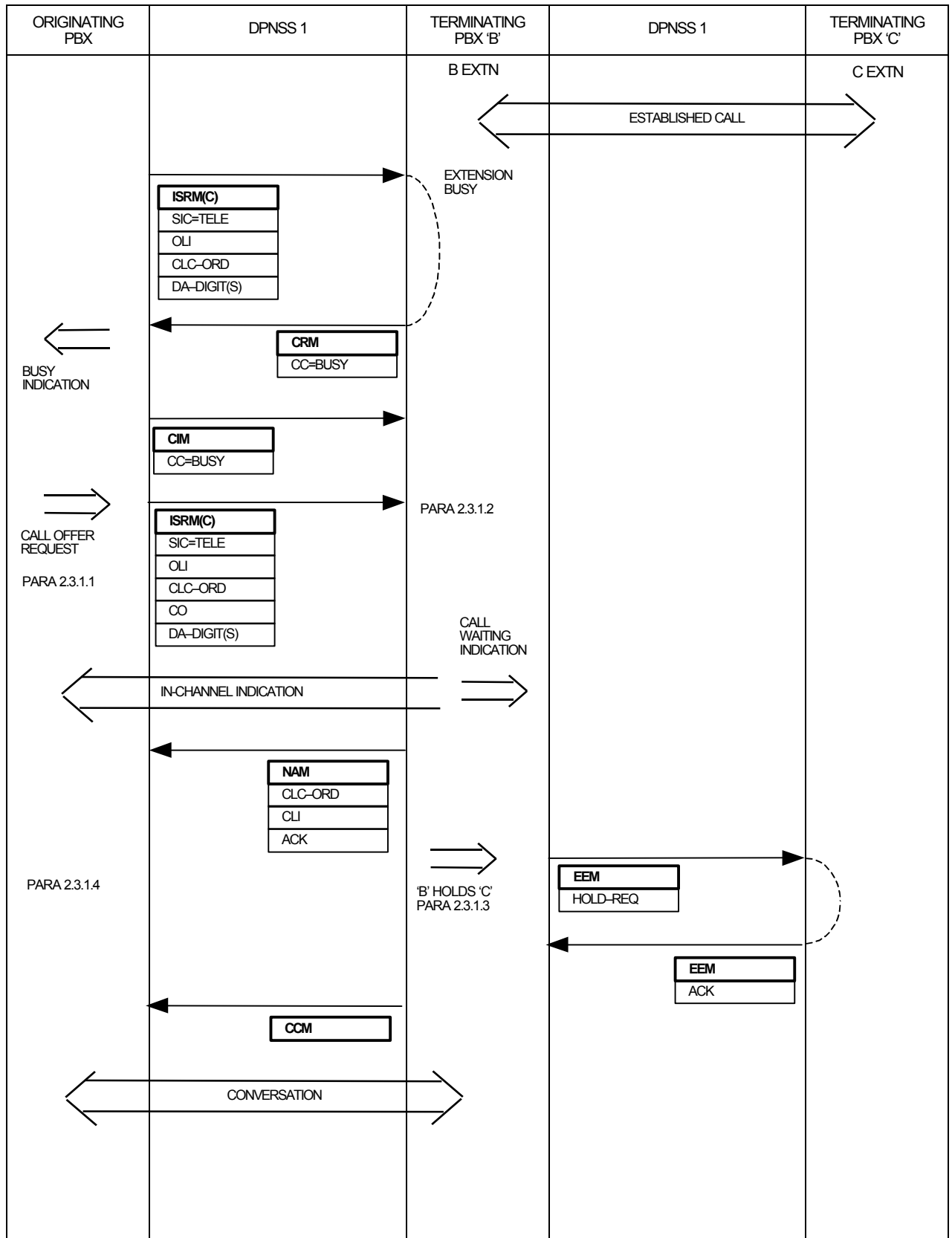

2.3.1.1 A Call Offer request will normally follow an unsuccessful call attempt. The period following an unsuccessful attempt during which Call Offer can be requested is dependent upon the design of the PBX.

Subject to the originating extension having the Call Offer capability, an ISRM shall be used to establish a connection to the wanted extension. The difference between this and a Simple Call ISRM is that it shall contain a Call Offer Request (CO).

2.3.1.2 The request shall be validated against the Class of Service of the called extension and its call state (eg whether the called party is engaged upon a three-party call).

If the called party has become free the call shall be completed as for a Simple Call.

If the Call Offer request is acceptable, Call Waiting Indication shall be applied to the called extension and the calling party given an in-channel indication that Call Waiting Indication is being applied.

A NAM containing the Called Line Category, Called Line Identity, and Acknowledge is returned to the Originating PBX.

Note: Call Waiting Indication is not applied to the unwanted extension.

If the called extension would normally accept the call, if it were free, but Call Offer is not allowed, a CRM containing Clearing Cause: BY shall be returned on the signalling channel and a CIM expected in response.

If the called extension is in a state where it cannot receive calls (eg Out of Service) the call shall be cleared with a CRM containing the appropriate Clearing Cause (see SECTION 4, ANNEX 3).

2.3.1.3 The party receiving the Call Waiting Indication may accept the call either by clearing the existing call or by placing the existing call on Hold.

If the wanted party clears, a CRM shall be sent to the unwanted party as for a Simple Call clear-down sequence, and an EEM containing SOD-F shall be sent to the Originating PBX on the signalling channel. The wanted party shall be re-called and the waiting call treated as a Simple Call.

If the wanted party places the call on Hold and accepts the waiting call, a CCM shall be sent to the Originating PBX. A transmission path between the calling and wanted parties shall be established. If the existing call is to an extension on another DPNSS 1 PBX, the Hold Supplementary Service procedures may be applied (see SECTION 12). Where the PBX supports the Three-Party Service, the Hold action may allow further Three-Party procedures, after the waiting call has been accepted.

If Call Waiting Indication is rejected by the called party, a CRM containing the Clearing Cause: REJ shall be sent on the signalling channel and a CIM expected in response.

2.3.1.4 If a CRM containing Clearing Cause: REJ is received, a CIM shall be sent in response and an appropriate indication applied to the requesting extension.

The Originating PBX may clear the call after a timeout, if the wanted party ignores the Call Waiting Indication. A CRM containing Clearing Cause: CT shall be sent, a CIM shall be expected in response and an appropriate indication given to the requesting extension.

If the caller clears without the call being completed, a CRM containing Clearing Cause: Call Termination (CT) shall be sent to the wanted party's PBX and a CIM expected in response. If Call Waiting Indication is being applied to the wanted extension, it shall be removed.

2.3.2 CALL OFFER CONVERTED TO INTRUSION

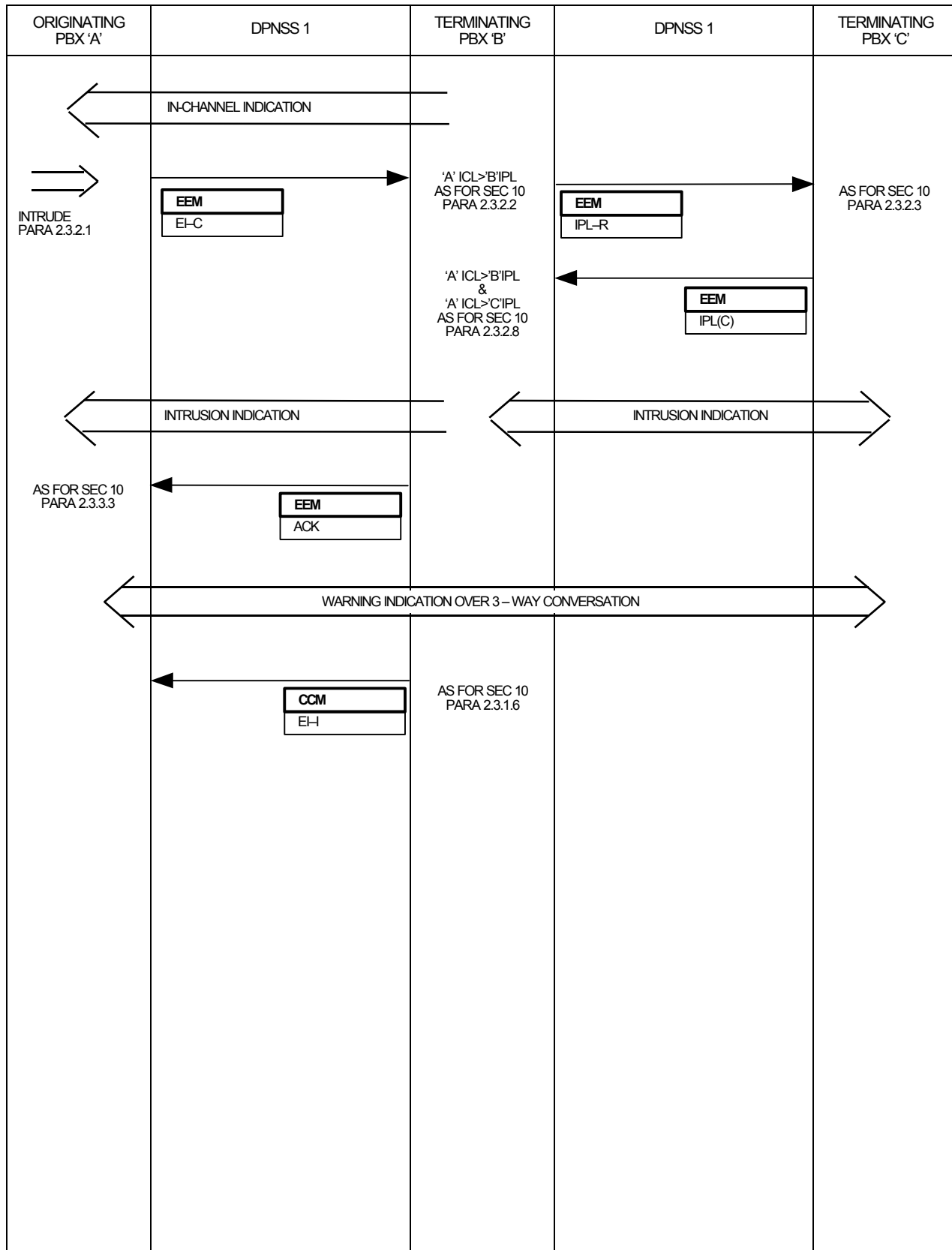

2.3.2.1 If the originating party requests Intrusion after receipt of the indication that the call is waiting at the wanted party's PBX, an EEM containing the String, "Executive Intrusion-Convert (EI-C)" shall be sent by the Originating PBX to the wanted party's PBX. The Parameter to the EI-C String is the requesting party's Intrusion Capability Level (ICL).

2.3.2.2 On receipt of the EEM containing the EI-C String when the wanted extension is still busy and intrudable, the IPL of the unwanted extension shall be requested using the sequence described in SECTION 10 paragraphs 2.3.2.2 to 2.3.2.4.

If, after checking the intrudable states of the wanted and unwanted parties, at the wanted party's PBX, it is determined that Intrusion can not take place, an EEM containing REJ shall be returned to the Originating PBX and the waiting state maintained.

If Intrusion is permitted, waiting indications shall be removed by the wanted party's PBX, Intrusion Indication applied, and the call shall be completed as described in SECTION 10, paragraph 2.3.2.8 for a successful Intrusion.

Since Conversion to Executive Intrusion is an optional part of this Service, a PBX not offering the option will treat the EI-C String as unrecognised and return an EEM containing String SNU to the Originating PBX and leave the call in the waiting state.

2.3.2.3 If, in response to the EEM containing EI-C, the requesting PBX receives an EEM containing ACK, this signifies that the Intrusion is proceeding (as described in SECTION 10, paragraph 2.3.2.9).

If an EEM containing REJ or SNU is received, an appropriate indication may be given to the requesting party and the call shall remain in the waiting state.

3 COMPLIANCE SHEETS FOR SUPPLEMENTARY SERVICE: CALL OFFER

The Call Offer Supplementary Service is an optional part of DPNSS 1 and its provision on a PBX is a matter for negotiation between a customer and his supplier (see FOREWORD in SECTION 0 of this specification). This Subsection may be used as an aid to those negotiations.

NOTE: Whilst the provision of this service is optional, if it is provided, compliance with certain features of the service becomes mandatory.

Compliance with the service is considered in terms of the function(s) to be performed by the PBX ie Transit, End or Branching and the extent to which operators or extensions on the PBX can request the service.

The options available are given in TABLE 1. This table should be completed by a manufacturer to indicate PBX capability and by a purchaser to indicate PBX requirements.

TABLES 2 to 4 indicate the features that are required/provided at each PBX. The preprinted "YES" indicates that the feature is a mandatory part of the service for that PBX function.

TABLE 1

PBX FUNCTION		APPLICABLE TABLE
PBX with operators or extensions, some of which can request the service		TABLES 2 & 3
PBX with operators or extensions none of which can request the service.		TABLE 2
Transit PBX		TABLE 4

TABLE 2

COMPLIANCE TABLE FOR A PBX WITH OPERATORS OR EXTENSIONS IN A NETWORK THAT SUPPORTS CALL OFFER		
SERVICE VARIANT		COMMENT
Able to accept a Call Offer Request?	YES	
Able to accept an offered call by clearing the existing call?		
Able to accept an offered call by placing the existing call on hold?		
Able to indicate to the caller that the extension has rejected the offered call?		
Able to accept a request to convert to Executive Intrusion on an offered call?		

TABLE 3

ADDITIONAL COMPLIANCE TABLE FOR A PBX WITH OPERATORS OR EXTENSIONS THAT ARE ABLE TO REQUEST CALL OFFER		
SERVICE VARIANT		COMMENT
Able to request that a call be offered to a busy extension on another DPNSS 1 PBX?	YES	
Able to take further action should the Call Offer be ignored by the wanted party for a length of time?		State action taken
Able to request conversion to Executive Intrusion on an offered call?		

TABLE 4

COMPLIANCE TABLE FOR A TRANSIT PBX IN A NETWORK THAT SUPPORTS CALL OFFER		
SERVICE VARIANT		COMMENT
Able to transit Call Offer Requests? Able to transit Executive Intrusion-Conversion Requests?	YES	Inherent DPNSS 1 capability

DIGITAL PRIVATE NETWORK SIGNALLING SYSTEM NO 1 (DPNSS 1)

SECTION 15 - SUPPLEMENTARY SERVICE : NON-SPECIFIED INFORMATION

CONTENTS

1	GENERAL	Page 2
2	SUPPLEMENTARY SERVICE - NON-SPECIFIED INFORMATION	Page 3
2.1	DEFINITION.....	Page 3
2.2	DESCRIPTION.....	Page 3
2.3	OUTLINE OF OPERATION.....	Page 5
2.3.1	Non-Specified Information - Relevant to Routing.....	Page 6
2.3.2	Non-Specified Information - Sent Forward After the NAM.....	Page 8

HISTORY

ISSUE 1 - February 1984
Issue 2 - September 1984
Issue 3 - March 1986
Issue 4 - December 1989

Issue 5 - March 2001 - Specification renamed as DPNSS[188]
- Table 1 extended and brought up to date
- Reference to requesting new manufacturer identifiers changed.
- Recommendation concerning excessive message sending added.

1 GENERAL

- 1.1** This Section details the signalling requirements of DPNSS 1 for the Supplementary Service: Non-Specified Information.
- 1.2** Subsection 2 details the service within DPNSS 1.
- 1.3** The description is given in the form of Message Sequence Diagrams (MSDs) followed by explanatory text.
- 1.4** The text is referenced from MSDs at appropriate points in the sequences.
- 1.5** Message contents for successful calls are shown in MSDs. Messages and their contents for alternative sequences (eg for unsuccessful calls) are detailed in the text.
- 1.6** Coding of the contents of messages is given in SECTION 4.

2 SUPPLEMENTARY SERVICE - NON-SPECIFIED INFORMATION

2.1 DEFINITION

The Non-Specified Information (NSI) Supplementary Service permits a network to exploit the DPNSS 1 signalling scheme to implement network-dependent features/functions.

Such functions, being dependent on a given network implementation, are impossible to define in the DPNSS 1 specification itself, but this Section of the specification specifies the necessary "hooks", and their usage.

2.2 DESCRIPTION

This Supplementary Service enables information exchange to take place between PBXs in the network, to supplement the information flows in a network-dependent manner.

The information exchange can occur between any PBXs in a network, and at any point in a call. It can occur in conjunction with any other service.

The information is conveyed by means of one or more Supplementary Information Strings, which can be included in the Selection or Indication Fields of any message.

Each Supplementary Information String will contain as a minimum the NSI Supplementary Information String Identifier plus a first Parameter consisting of two IA5 characters. The first character identifies the manufacturer of the sending PBX (as shown in TABLE 1), whilst the second character is defined by the manufacturer in question.

NOTE: When an NSI string is not understood, the structure of the rejection-of-strings Message differs from normal (see SECTION 4, ANNEX 2, Paragraph 3 "ENHANCED STRING ID, STRING ID, STRING ID LIST" Parameters).

If more information needs to be sent additional Parameters are used. These Parameters are constructed in accordance with SECTION 4, ANNEX 2.

Non-Specified Information will be marked by the Originating PBX with the Identifier Suffix as Informative, Optional or Mandatory for the various PBX functions. However, unlike other Supplementary Information Identifiers, NSI cannot be pre-allocated a suffix, since it is dependent on the unspecified contents.

In order to minimise the buffering and processing load on Transit PBXs during call set-up, the NSI in ISRMs, RMs and SSRMs should be kept to a minimum, except when required to influence routing.

Any additional information is sent by means of NSI strings in EEMs or LLMs after the NAM.

The inclusion of the Supplementary Information String in the call set-up messages enables account to be taken of the service at the earliest opportunity, rather than waiting for receipt of forward EEMs or LLMs (which are conditional on the receipt of a NAM by the Originating PBX).

There is no limit on the number or occurrence of backward NSI Strings. NSI Strings can occur in NIMs (ie before the NAM), in the NAM, in LLMs or in EEMs (ie after the NAM), or in the CCM. In the case of the call being cleared the NSI Strings may be included in the CRM or RRM.

Since specification of the minimum signalling throughput requirements for a PBX is outside the scope of DPNSS 1, care should be taken when designing network specific services based on the use of NSI Strings with regard to the number of extra messages sent. A significant increase in message transmission compared to that which would apply for normal call handling might overload a component of the network which has been designed with only normal call handling in mind. Consequently, it is recommended that a PBX that is capable of generating messages purely for the conveyance of NSI Strings be equipped with a limiting mechanism that can be invoked to overcome adverse effects on the network arising from excessive use of such messages.

TABLE 1 - Allocation of Manufacturers' Identifiers

Identifier	Manufacturer
A	Siemens (formerly Plessey)
B	British Telecom
C	Mitel
D	Siemens (formerly GEC)
E	STC
F	Siemens (formerly Ferranti)
G	Philips
H	Lucent (formerly APT)
I	IBM
J	Ericsson
K	Siemens (formerly Plessey)
L	British Telecom
M	Siemens
N	Nortel
O	Interconnect Ltd
P	Dowty
Q	Gandalf
R	SDX Business Systems
S	Ericsson
T	Alcatel Business Systems
U	Cray Communications
V	Aspect Telecommunications
W	Hutchison Microtel
X	Marconi (formerly GPT)
Y	Westell Ltd (formerly 3Net)
Z	Rockwell Telecommunications

Other manufacturers can be allocated an identifier on request, in the first instance, to the chairman of the NICC/PNO-IG/ISC at the address on the title page.

2.3 OUTLINE OF OPERATION

Non-Specified Information is a general service that can be invoked at any point in a call, and during any service. Consequently, the following MSDs are not exhaustive, and are intended only as examples:

- 2.3.1 Non-Specified Information - Relevant to Routing.
- 2.3.2 Non-Specified Information - Sent Forward after the NAM.

2.3.1 NON-SPECIFIC INFORMATION - RELEVANT TO ROUTING

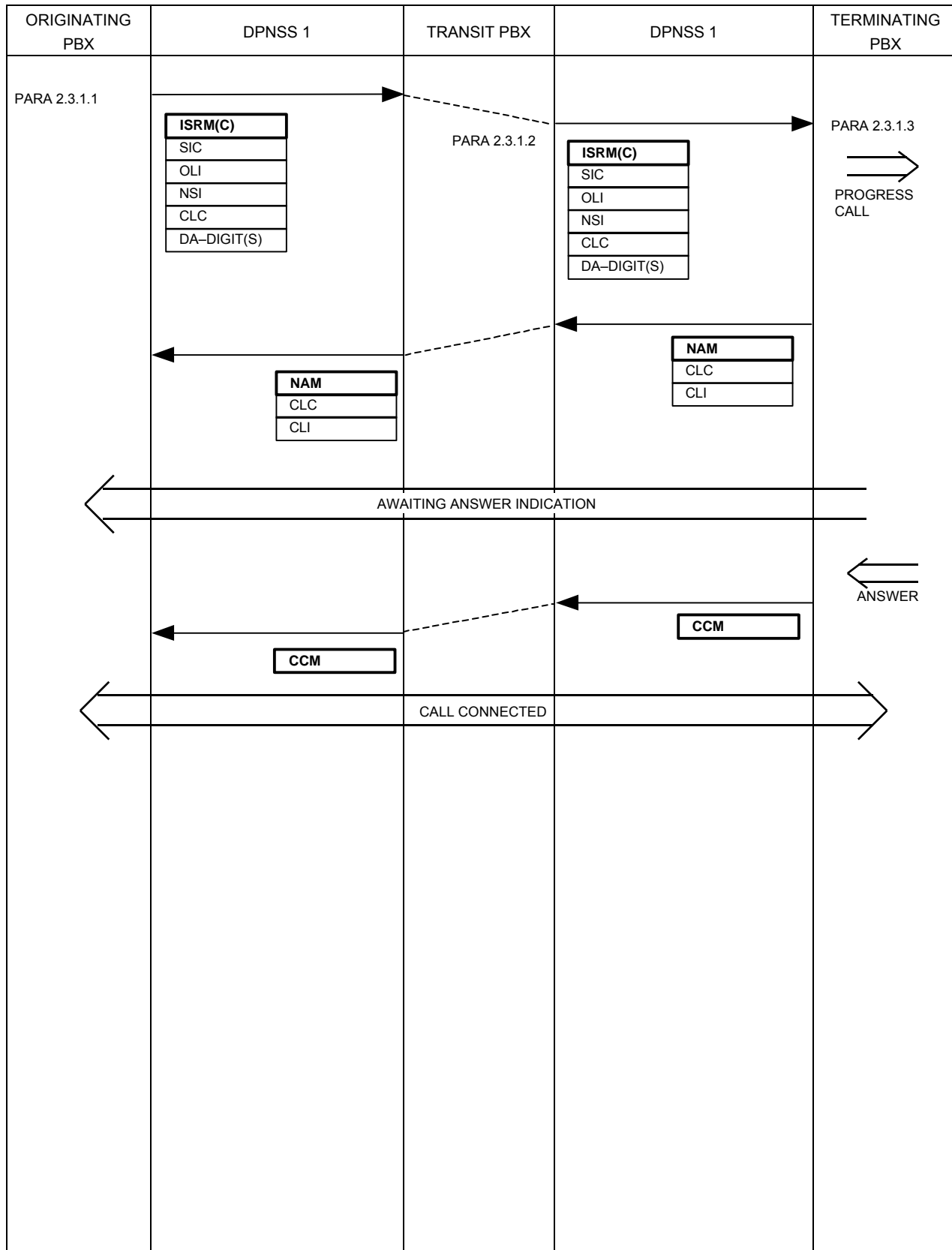

2.3.1.1 In this example the NSI is relevant to routing and may therefore consist of more than one Parameter.

2.3.1.2 Transits will act on the NSI String and pass it on.

2.3.1.3 The Terminating PBX will act on the NSI String (if any action is required) and continue with the call set-up.

2.3.2 NON-SPECIFIC INFORMATION – SENT FORWARD AFTER THE NAM

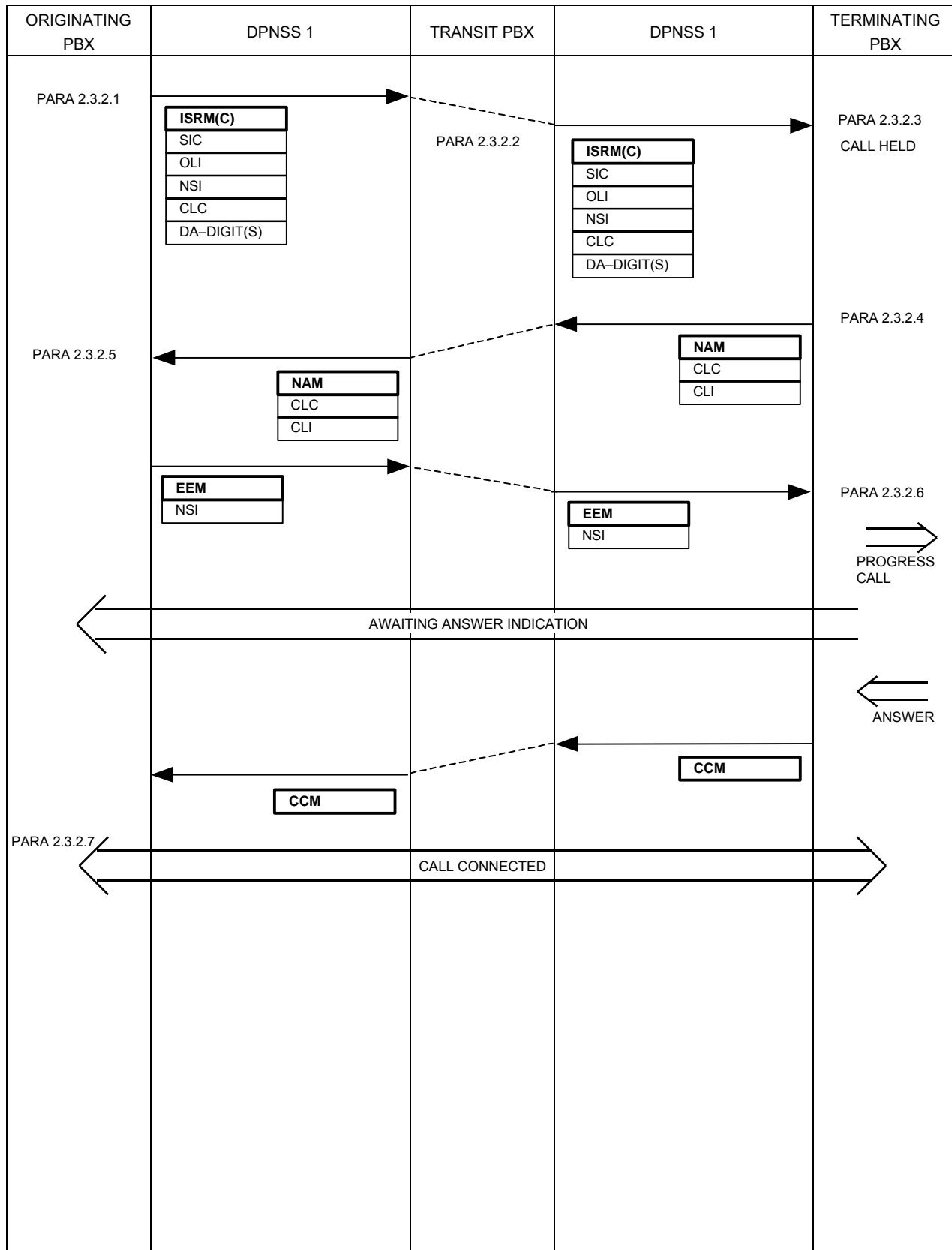

2.3.2.1 In this example the NSI is not relevant to routing therefore only the Supplementary Information Identifier and first Parameter are contained in the ISRM (or RM) if required.

2.3.2.2 The Transit PBXs will simply pass on the NSI supplementary information since it is not relevant to them.

2.3.2.3 If, after looking at the first Parameter, the Terminating PBX determines it is capable of acting upon NSI the PBX's next action will depend on the second character of the Parameter field - the manufacturer's definable character.

The simplest case is that the two-IA5-character Parameter is sufficient for the Terminating PBX to progress the call and no backward NSI or further forward NSI is required (an example of this would be the manufacturer's character indicating special ringing requested). In this case the call would continue from 2.3.2.6 after sending the NAM.

2.3.2.4 In the example shown, the character has informed the Terminating PBX that processing of the call must be suspended pending further NSI Strings from the Originating PBX.

The NAM is sent to the Originating PBX informing it that the Terminating PBX has been reached.

It may also be the case that the manufacturer's character indicates that some backward NSI Strings are required by the Originating PBX before the call could be progressed, in which case these could also be contained in the NAM.

2.3.2.5 Receipt of the NAM at the Originating PBX indicates that the call has been successfully routed, and forward EEMs can now be sent.

Subsequently, the outstanding NSI Strings are sent in one or more EEMs each EEM containing a number of complete NSI Supplementary Information Strings.

2.3.2.6 Once the Terminating PBX has received/responded to sufficient NSI Strings the call is progressed.

2.3.2.7 Once the call is connected, forward or backward NSI Strings may be sent via existing message flows, with no restrictions other than that previously described for RMs.

DIGITAL PRIVATE NETWORK SIGNALLING SYSTEM NO 1 (DPNSS 1)

SECTION 16 - SERVICE-INDEPENDENT STRINGS

CONTENTS

1	GENERAL	Page 3
2	SERVICE-INDEPENDENT STRINGS WITHIN DPNSS 1	Page 5
2.1	DEFINITION.....	Page 5
2.2	DESCRIPTION.....	Page 5
2.3	OUTLINE OF OPERATION.....	Page 5
3	SERVICE-INDEPENDENT STRING DESCRIPTIONS	Page 6
3.1	CLASS OF SERVICE (COS).....	Page 6
3.2	HUNT GROUP FORWARDED (HGF).....	Page 7
3.3	SATELLITE BARRED (SAT-B).....	Page 8
3.4	DIRECT ROUTE SELECT (DRS).....	Page 8
3.5	TEXTUAL DISPLAY (TEXT).....	Page 9
3.6	INTERCOM CALL (ICC).....	Page 9
3.7	QUEUE INFORMATION (Q-INFO).....	Page 10
3.8	PASSWORD (PASSW).....	Page 11
3.9	SERVICE INFORMATION (SERV).....	Page 11
3.10	TRUNK IDENTITY (TID).....	Page 12
3.11	SUPPLEMENTARY FACILITIES INHIBITED (SFI).....	Page 13
3.12	AUTO-ANSWER (AUTO-A).....	Page 13
3.13	HANDS FREE - ACTIVATED (HF-A).....	Page 13
3.14	HANDS FREE - DEACTIVATED (HF-D).....	Page 14
3.15	DASS 2 SERVICE INDICATOR CODE (D-SIC).....	Page 14
3.16	DEVICE IDENTITY (DI).....	Page 14
3.17	NETWORK ADDRESS EXTENSION CALLING /CALLED IDENTITY - COMPLETE (NAE-CC) - INCOMPLETE (NAE-CI).....	Page 15

3.18	INTERNAL REROUTING DISABLED (IRD)	Page 16
3.19	EXTERNAL REROUTING DISABLED (ERD)	Page 16
3.20	QUEUEING PRIORITY (Q-PRIO)	Page 17
3.21	VPN INITIATED CLEAR (VIC)	Page 18
3.22	ASSISTANCE INFORMATION (ASST-INFO)	Page 18
3.23	AUXILIARY ROUTE RESTRICTION CLASS (ARC)	Page 19
3.24	REDIRECTION CONTROL (RDC)	Page 19
3.25	MESSAGE INDEX (M-INDEX)	Page 20
3.26	VPN - NODAL IDENTITY (V-NID)	Page 20
3.27	NETWORK SIGNALLING LIMIT (NSL)	Page 21
3.28	MALICIOUS CALL INDICATION (MCI)	Page 21
3.29	INTERIM ANSWER (INT-A)	Page 22
3.30	ROUTE OPTIMISATION INVITE (ROP-INV)	Page 23
3.31	PUBLIC CALLING PARTY NUMBER - PROVIDED (PCLG-P)	Page 24
3.32	PUBLIC CALLING PARTY NUMBER - DEFAULT (PCLG-D)	Page 24
3.33	PUBLIC CONNECTED NUMBER - PROVIDED (PCON-P)	Page 26
3.34	PUBLIC CONNECTED NUMBER - DEFAULT (PCON-D)	Page 26
4	COMPLIANCE	Page 27

HISTORY

Issue 1 - February 1984
Issue 2 - March 1986
Issue 3 - December 1989
Issue 4 - January 1995

Issue 5 - March 2001 - Specification renamed as DPNSS[188]
- Sections 3.29 to 3.34 added

1 GENERAL

This Section gives details of a number of Supplementary Information Strings which may be used in association with a Simple Call (SECTIONS 6 and 7) or with Supplementary Services (SECTIONS 8 to 48). The use of these Strings is optional and flexible within the rules of DPNSS 1.

Subsection 3 defines each Service-Independent String and its associated Parameters and gives broad examples of the use of each within a DPNSS 1 network.

Subsection 4 shows the Compliance.

Codings of Supplementary Information String Identifiers and Parameters are given in SECTION 4, ANNEX 2.

The alphabetical index below may be used to aid location of particular Service-Independent String descriptions from their mnemonics.

ALPHABETICAL INDEX TO SERVICE-INDEPENDENT STRINGS

Mnemonic	(Code)	Name	Paragraph
ARC	(211)	Auxiliary Route Restriction Class	3.23
ASST-INFO	(205)	Assistance Information	3.22
AUTO-A	(199)	Auto-Answer	3.12
COS	(18)	Class of Service	3.1
D-SIC	(57A)	DASS 2 Service Indicator Code	3.15
DI	(109)	Device Identity	3.16
DRS	(160)	Direct Route Select	3.4
ERD	(194)	External Rerouting Disabled	3.18
HF-A	(200)	Hands Free - Activated	3.13
HF-D	(201)	Hands Free - Deactivated	3.14
HGF	(29)	Hunt Group Forwarded	3.2
ICC	(87)	Intercom Call	3.6
INT-A	(246A)	Interim Answer	3.29
IRD	(193)	Internal Rerouting Disabled	3.18
M-INDEX	(244)	Message Index	3.25
MCI	(222K)	Malicious Call Indication	3.28
NAE-CC	(173)	Network Address Extension - Calling/Called Identity Complete	3.17
NAE-CI	(174)	Network Address Extension - Calling/Called Identity Incomplete	3.17
NSL	(223)	Network Signalling Limit	3.27

ALPHABETICAL INDEX TO SERVICE-INDEPENDENT STRINGS (CONT.)

Mnemonic	(Code)	Name	Paragraph
PASSW	(77B)	Password	3.8
PCLG-D	(252)	Public Calling Party Number - Default	3.32
PCLG-P	(251)	Public Calling Party Number - Provided	3.31
PCON-D	(254)	Public Connected Number - Default	3.34
PCON-P	(253)	Public Connected Number - Provided	3.33
Q-INFO	(135)	Queue Information	3.7
Q-PRIO	(136)	Queueing Priority	3.20
RDC	(230)	Redirection Control	3.24
ROP-INV	(249)	Route Optimisation Invite	3.30
SAT-B	(165)	Satellite Barred	3.3
SERV	(166)	Service Information	3.9
SFI	(158)	Supplementary Facilities Inhibited	3.11
TEXT	(100)	Textual Display	3.5
TID	(167)	Trunk Identity	3.10
V-NID	(243)	VPN - Nodal Identity	3.26
VIC	(208)	VPN Initiated Clear	3.21

2 SERVICE-INDEPENDENT STRINGS WITHIN DPNSS 1

2.1 DEFINITION

Service-Independent Strings are Supplementary Information Strings which may be used in addition to the Strings required to perform a Simple Call or Supplementary Service. Their use does not change the way in which the Simple Call or Supplementary Service works.

2.2 DESCRIPTION

Service-Independent Strings are used to provide information over and above that available from a particular service. Examples of the use of this additional information are:

- to assist in the control of call connections;
- to provide information for display.

2.3 OUTLINE OF OPERATION

Service-Independent Strings may be added to any message unless otherwise stated in the relevant Section or Sections of DPNSS[188].

3 SERVICE-INDEPENDENT STRING DESCRIPTIONS

3.1 CLASS OF SERVICE (COS)

3.1.1 String Definition

This String is used to convey the Class of Service of a party. The Class of Service comprises three parts:-

- Route-Restriction Class
- Call-Barring Group
- Facility-List Code

All three parts may be used for display or logging purposes at the recipient PBX. In addition, PBXs may use some parts to determine whether to allow or bar a call or facility. For example, if the String is present in an ISRM or RM, a Transit or Gateway PBX may use the Route Restriction Class to determine whether the caller is entitled to use a route out of the PBX, and a Terminating PBX may use the Call-Barring Group to determine whether the caller is entitled to call the destination.

Route-Restriction Classes, Call-Barring Groups and Facility-List Codes should be configured to have the same or similar meanings at each PBX in a network. However, there may be detailed differences between the PBXs from different manufacturers. For example, a particular facility, which is under Class Of Service control on one PBX, may be available either unconditionally or not at all on another PBX. In the case of Route-Restriction Class, there may be geographical differences. For example, access to a particular PSTN destination may be allowed from those PBXs from which it can be reached by a local call, but barred from PBXs from which it requires a long-distance call.

It is possible that the Parameters of the COS String may be used by different PBXs in the same network in an incompatible manner. Thus a PBX which supports the COS String must be flexible enough to be able, if necessary, to ignore any of the Parameters received. Any mechanism may be employed to do this, such as ignoring a Parameter on analysis of the OLI String, or arranging via configuration that certain Parameter values cause the same action as a null Parameter.

3.1.2 String Parameters

3.1.2.1 Route-Restriction Class

The Route-Restriction Class indicates the routing entitlements of the party. It can restrict not only the routes that the party can use when originating a call, but also the destinations which the party may reach via those routes. For example, a particular class may indicate that trunk calls are barred; this would restrict access to a PSTN route depending on the Destination Address. The significance of a particular Route Restriction Class is network dependent.

3.1.2.2 Call Barring Group

The Call-Barring Group indicates the party's entitlement to make calls to or receive calls from other parties. Whether a call is allowed or not depends on the Call-Barring Groups to which the calling and called parties belong. For a given pair of groups, calls may be either allowed or barred, according to network requirements.

3.1.2.3 Facility List Code

The Facility List Code indicates the facilities the party is allowed to use. For a particular Facility-List Code, the list of facilities available is network dependent.

3.2 HUNT GROUP FORWARDED (HGF)

3.2.1 String Definition

A call's Destination Address may be the address of a hunt group. On arrival at a PBX at which the hunt group is registered, a member is selected and the call is forwarded to that member. If the number is not available for any reason, eg busy, a different member is selected.

If the hunt group extends across more than one PBX, the call may be forwarded over a DPNSS 1 route. The address of the member replaces the address of the hunt group as the Destination Address in the ISRM or RM, and String HGF is included to indicate to the Terminating PBX that the call has been forwarded from a hunt group. The Terminating PBX may use this information for purposes such as the following.

- To avoid or limit the nesting of hunt groups.
- To take special action on encountering Supplementary Services such as Diversion or Call Waiting.
- To provide an indication to the called party.

3.2.2 String Parameters

3.2.2.1 Nesting Level

The number of hunt groups the call has passed through.

3.3 SATELLITE BARRED (SAT-B)

3.3.1 String Definition

This indicates that a satellite route is not to be selected. It is used typically where a call has already been routed across one satellite link, but may also be used to avoid satellite links altogether.

3.3.2 String Parameters

None.

3.4 DIRECT ROUTE SELECT (DRS)

3.4.1 String Definition

This String is used in an ISRM or RM to indicate that a call is not to use alternative routes.

Where the destination is outside the DPNSS 1 network, the Destination Address may imply a particular route. The use of String DRS ensures that the implied route is used even though it may not be the first-choice route to the destination.

Examples of the use of this service are:

- To ensure selection of a route with higher-grade circuits.
- To avoid selection of route known to be causing problems.
- To avoid selection of a more expensive route.
- For test calls.

3.4.2 String Parameters

None.

3.5 TEXTUAL DISPLAY (TEXT)

3.5.1 String Definition

This String conveys text for display at the receiving extension. If the text cannot be displayed, it may be discarded. Examples of the way in which it may be used are:

- To provide additional information about an extension (eg the name of the user), when sent with the OLI/CLI.
- To provide textual description of the reason why a call failed, when sent with a Clearing Cause.

3.5.2 String Parameters

3.5.2.1 Text

The text may comprise any IA5 characters, but note the special coding for * and # (see SECTION 4, ANNEX 2).

3.5.2.2 Text Type

This indicates the meaning of the text provided. It may indicate, for example, that it is a name, a message, or a Clearing Cause.

3.6 INTERCOM CALL (ICC)

3.6.1 String Definition

This String indicates that the call is between two closely associated extensions, enabling the Terminating PBX to take certain special actions. The actions taken are PBX dependent, but the following may be affected:

- calling signal or display
- call logging
- action taken on encountering Diversion Immediate
- action taken on encountering DND
- action taken on encountering busy
- action taken in the event of no reply

3.6.2 String Parameters

None.

3.7 QUEUE INFORMATION (Q-INFO)

3.7.1 String Definition

This String is used to indicate the number of unanswered calls currently waiting on an extension number and the number of positions capable of answering it. If the string is used within a call currently queued, that call shall be included, otherwise it shall not be included. This information may be used for display purposes at the Originating PBX.

Examples of its use are as follows:

- In a CRM containing Clearing Cause :BY to indicate the number of devices currently queued.
- In a NAM, following an ISRM containing "Call Offer (CO)" to indicate the position in the queue.
- In a NAM containing "Call Waiting (CW)" to indicate the position in the queue.
- In an EEM, following the NAM in a Call Offer or Call Waiting call, to indicate the position in the queue following a change.

3.7.2 String Parameters

3.7.2.1 Number of Calls

This indicates the number of unanswered calls currently Waiting on an extension number, or the position of a call currently queued.

3.7.2.2 Number of Servers

This indicates the number of positions capable of answering the queued calls.

3.8 PASSWORD (PASSW)

3.8.1 String Definition

This String is used in cases where unconditional use of a service is limited to privileged users, but where non-privileged users are entitled to use the service under password control. When such a service is invoked by a non-privileged user, a password is then sent to the required PBX for checking.

The use of this String is primarily aimed at services where it is possible to change data held at one PBX from another PBX, eg Remote Registration and Cancellation of Diversion.

If the message containing the request for such a service does not contain PASSW, the receiving PBX shall assume that the sending PBX has verified that the user has sufficient privilege to use the service without supplying a password.

3.8.2 String Parameters

3.8.2.1 Password

The password shall comprise up to 12 alpha or numeric characters.

3.9 SERVICE INFORMATION (SERV)

3.9.1 String Definition

This String is used to provide additional information as to which services may be used later in a call. Its use is intended to reduce the number of attempts to use services which will then fail. It may also be used for display purposes.

The String may be sent either in a message which also contains the relevant party details or in a message where the relevant party details can be inferred. If, for example, a NAM is received containing CLI, CLC and SERV, then SERV relates to the extension being rung. On the other hand, for example, if a CRM is received containing SERV with no party details, then SERV shall be assumed to relate to the extension identified by the DA in the ISRM used for the call setup attempt.

3.9.2 String Parameters

3.9.2.1 Services

This indicates which of the following services may be used:

- Call Offer; Executive Intrusion; Call Back When Free; Call Back Messaging; Hold, and Call Back When Next Used.

3.10 TRUNK IDENTITY (TID)

3.10.1 String Definition

This String is used in conjunction with a CLC to identify a trunk, either a channel at a Gateway between DPNSS 1 and another signalling system or a traffic channel within the DPNSS 1 network.

The use of this String to identify a trunk is equivalent to that of the String OLI/CLI to identify an extension.

The String provides reference numbers to identify:

- the PBX
- the trunk group to which the required trunk belongs
- the trunk member within that group.

The meaning of the second and third of these is limited outside the PBX which sent it.

This String may be enhanced in future issues of this specification to enable the identification of sub-channels within a channel, or a group of channels being used for the same connection (ie sub-multiplexed and super-multiplexed channels, respectively).

3.10.2 String Parameters

3.10.2.1 PBX Reference Number

A sequence of digits to identify the PBX sending the TID String. If this is used as a Destination Address it will cause routing to the sending PBX.

3.10.2.2 Trunk Group Reference Number

A Trunk Group is a collection of one or more Trunk Members. The Reference Number identifies the Trunk Group at a particular PBX.

3.10.2.3 Trunk Member Reference Number

In the case of digital trunks with no sub- or super-multiplexing, a Trunk Member is a single channel and in the case of analogue trunks, it is an individual trunk circuit. The Reference Number identifies the Trunk Member within a particular Trunk Group at a particular PBX.

3.11 SUPPLEMENTARY FACILITIES INHIBITED (SFI)

3.11.1 String Definition

This String may be used to instruct the PBX at the other end of the call to inhibit the use of any Supplementary Services which may affect the handling of the call. The exact use of this String is PBX dependent, as different PBXs support different services which may be affected.

3.11.2 String Parameters

None.

3.12 AUTOANSWER (AUTO-A)

3.12.1 String Definition

This String may be included in a CCM to indicate that answer has been generated by the called terminal equipment, rather than by user action.

3.12.2 String Parameters

None.

3.13 HANDS-FREE - ACTIVATED (HF-A)

3.13.1 String Definition

This String may be used to indicate that a calling or called party has hands-free (loud-speech) operation activated, thus implying that the call is potentially less private than a normal two-party call. It may be sent at call set-up (to indicate the initial setting), after call set-up, when the setting changes, or when party details are exchanged (eg on receipt of an EEM containing TRFD).

3.13.2 String Parameters

None.

3.14 HANDS-FREE - DEACTIVATED (HF-D)

3.14.1 String Definition

This String may be used to indicate that a calling or called party has hands-free (loud-speech) operation deactivated. It may be sent at call set-up (to indicate the initial setting), after call set-up when the setting changes, or when party details are exchanged (eg on receipt of an EEM containing TRFD).

3.14.2 String Parameters

None.

3.15 DASS 2 SERVICE INDICATOR CODE (D-SIC)

3.15.1 String Definition

This String may be used to convey DASS 2 Service Indicator Codes (SICs) within a DPNSS 1 message when there is no equivalent DPNSS 1 SIC.

The String would normally be used in conjunction with calls to or from DASS 2, however, it may be used on calls wholly within a DPNSS 1 network between extensions that have capabilities that can utilise the DASS 2 SICs.

3.15.2 String Parameters

3.15.2.1 SIC

This is a representation of the required DASS 2 SIC.

3.16 DEVICE IDENTITY (DI)

3.16.1 String Definition

It is possible that a Destination Address (DA), an OLI or CLI String may not uniquely define a termination. For example, more than one extension might have the same CLI. The Device Identity (DI) String may be used in such situations in conjunction with the DA, OLI or CLI in order to specify one particular termination.

3.16.2 String Parameters

3.16.2.1 Device Index

This is a number used to identify one of the possible terminations for a given DA, OLI or CLI such that it is uniquely defined.

3.17 NETWORK ADDRESS EXTENSION - CALLING/CALLED IDENTITY COMPLETE (NAE-CC) AND INCOMPLETE (NAE-CI)

3.17.1 String Definitions

If a call originates or terminates at a device which is capable of using the NAE service, it may be appropriate to indicate a subaddress in conjunction with the DPNSS 1 OLI or CLI. The Strings NAE-CC and NAE-CI can be used for this purpose in a similar manner to the use of NAE-DC and NAE-DI for specifying a subaddress in conjunction with a Destination Address (see SECTION 41).

3.17.2 String Parameters

The Parameter to these Strings is the subaddress which is formatted in the same way as the NAE-DC and the NAE-DI Strings.

In most cases, the String NAE-CC (NAE Calling/Called Identity Complete) will suffice to convey the NAE data. However, for very long subaddresses, it may be necessary to split the NAE data into two Strings and send it in two messages so as not to exceed the 45-octet limit on messages.

On receipt, the subaddress is reconstructed by concatenation. Such Parameter splitting should be used only where absolutely necessary (ie where the NAE-CC String would otherwise be too long to fit in a single message). Where splitting is necessary, the subaddress may be split at any point, with the first part being sent as the Parameter to the String NAE-CI (NAE Calling/Called Identity Incomplete) and the remainder sent as the Parameter to an NAE-CC String.

The coding of the Parameters to the NAE-CI and NAE-CC Strings is given in SECTION 4. Note that it is possible to determine from the range of IA5 characters used in the Parameter coding whether the NAE data is in decimal or binary form. It follows that where NAE-CI and NAE-CC Strings are used together, the Parameter formats shall be the same, otherwise, one of the Strings shall be considered to contain a Parameter error and be acted upon accordingly.

3.18 INTERNAL REROUTING DISABLED (IRD)

3.18.1 String Definition

This String may be included in an ISRM, RM, CRM, RRM, or ERM to indicate that, on encountering congestion, rerouting internal to the DPNSS 1 network shall be disabled.

Internal Rerouting is defined as the alternative routing of a call via DPNSS 1, on detection of congestion, using the same Destination Address as that used on the call which encountered the congestion. Internal rerouting may take place at an Originating or Transit PBX by choosing a different DPNSS 1 route to that on which congestion was encountered, or at a Gateway PBX, where all suitable non-DPNSS 1 routes are congested, by routing the call via DPNSS 1 to another PBX (in which case the Gateway PBX becomes a Transit PBX).

3.18.2 String Parameters

None.

3.19 EXTERNAL REROUTING DISABLED (ERD)

3.19.1 String Definition

This String may be included in an ISRM, RM, CRM, RRM or ERM to indicate that, on encountering congestion, rerouting external to the DPNSS 1 network shall be disabled.

External Rerouting is defined as the alternative routing of a call, on detection of congestion, either:

- via another signalling system at any PBX along the congested call's path, or,
- via DPNSS 1, from an Originating PBX, by establishing a new call which uses a different Destination Address to that used on the call which encountered congestion.

3.19.2 String Parameters

None.

3.20 QUEUEING PRIORITY (Q-PRIO)

3.20.1 String Definition

Queueing Priority may be indicated in any call set-up attempt where there is a need to influence queueing order (eg, in the event that a Terminating PBX puts calls in a queue to await answer).

Examples of its possible use are in conjunction with Call Offer or Call Waiting, where the wanted party is permitted more than one waiting call, or Redirection-on-No-Reply to an operator where the calls might merit a higher answering priority than other calls.

The absence of Q-PRIO in a message may be taken to indicate that no special action need be taken (other than that which may be indicated by the presence of other Supplementary Information Strings in the message).

Queueing Priority may be used in three-party scenarios where a party is performing a service on behalf of another (such as an operator invoking Call Offer on an Enquiry Call, followed by Transfer of the offered call to the held party). In such a case the operator involvement itself may warrant inclusion of Q-PRIO in the ISRM of the Call Offer/Enquiry Call. Alternatively, if Q-PRIO had been received on the call from the originator to the operator, the priority so indicated may be used to determine a suitable priority for the Enquiry Call.

3.20.2 String Parameters

3.20.2.1 Priority Level

The Priority Level comprises a sequence of IA5 numerical characters representing the priority of the call as a number between 0 and 255 (decimal) where 0 represents the lowest priority and 255 the highest.

3.21 VPN INITIATED CLEAR (VIC)

3.21.1 String Definition

This String is used, in conjunction with a public network supported Virtual Private Network service, to indicate that call clearing has been initiated by the public network equipment.

An example of its use would be its inclusion in a CRM containing Clearing Cause: Congestion when that congestion was encountered between public network exchanges. VIC would not be used when the congestion was encountered on the DPNSS 1 channels between a PBX and the public exchange.

3.21.2 String Parameters

None.

3.22 ASSISTANCE INFORMATION (ASST-INFO)

3.22.1 String Definition

This String is used to indicate the type and level of assistance that is required on a call. The String may be added to an ISRM or RM on calls that are being routed to an operator (eg because of call failure, prolonged no reply, etc).

The String may also be included in a CRM, RRM, EEM or NAM to enable the receiving PBX to relay this information, if the call is subsequently routed to an operator.

3.22.2 String Parameters

3.22.2.1 Type of Assistance Required

This Parameter gives the history of the call requiring assistance, which may be used by the Operator PBX to select an appropriate operator position.

The Parameter also gives an indication of the urgency for assistance.

3.23 AUXILIARY ROUTE RESTRICTION CLASS (ARC)

3.23.1 String Definition

This String is used to enable an extension user to activate a limited number of barring levels in addition to those associated with the Route Restriction Class Parameter of the COS String.

The ARC may be used separately or in conjunction with the COS String. When used in conjunction with the COS String the barring requirements shall be based on the combination of both Strings.

3.23.2 String Parameters

3.23.2.1 Route-Restriction Class

See paragraph 3.1.2.1 of this Section.

3.24 REDIRECTION CONTROL (RDC)

3.24.1 String Definition

This String is used in cases where a PBX other than the Originating PBX either wishes to prevent an Originating PBX from invoking the Redirection Service, or wishes to specify the timer value that should be used if Redirection is to be invoked by the Originating PBX.

This String may be sent where there is a possibility that the Originating PBX may invoke Redirection. For example:

- in a NAM on a Simple Call, or in an EEM before sending the CCM, to stop or specify any CSA (Called Subscriber Answer) interception timer that may be running;
- in an EEM containing TRFD sent by a Transferring PBX if the transferring party wishes not to have calls redirected back to him/her;
- in an EEM containing the party details sent on receipt of an EEM containing TRFD when the transferred-to-party is unanswered and the transferred-to-PBX wishes to prevent or delay the call from being redirected away from the transferred-to-party.

The scenarios in which a PBX sends RDC are implementation dependent. Similarly, the scenarios in which a PBX that supports Redirection acts upon receipt of RDC are also implementation dependent (see Compliance Table).

3.24.2 String Parameters

3.24.2.1 Timer Value

If present, this Parameter indicates the timer value (in seconds) that the sending PBX wishes the Originating PBX to use if it is intending to initiate Redirection following a timeout. If the Parameter is not present, this indicates that the sending PBX wishes the Originating PBX to cancel any timed Redirection.

3.25 MESSAGE INDEX (M-INDEX)

3.25.1 String Definition

This String conveys the index of a predefined message (eg text, announcement, etc).

On receipt of M-INDEX, the associated message will be activated by the destination PBX or user equipment. If the Index Number is not allocated the String may be discarded.

3.25.2 String Parameters

3.25.2.1 Index Number

The Index Number comprises a sequence of IA5 numeric characters representing the message as a number between 0 and 255 (decimal).

The significance of a particular Index Number is network dependent.

3.26 VPN - NODAL IDENTITY (V-NID)

3.26.1 String Definition

This String is used in a Virtual Private Network (VPN) to identify the path of entry to a VPN. The identity to be assigned for this purpose is network dependent but could, for example, be part of a Destination Address, such as a PBX nodal identity.

The String may, for example, be inserted into an ISRM by the originating VPN node and be removed by the terminating VPN node.

3.26.2 String Parameters

3.26.2.1 VPN Access Reference Number

This Parameter is a sequence of IA5 numeric characters used to identify the path of entry to a VPN.

3.27 NETWORK SIGNALLING LIMIT (NSL)

3.27.1 String Definition

This String may be included in a CRM containing Clearing Cause: Network Termination (NT). Its inclusion indicates that the call has exceeded signalling limits imposed by the node of the network that has cleared the call.

3.27.2 String Parameters

None.

3.28 MALICIOUS CALL INDICATION (MCI)

3.28.1 String Definition

This String is used to indicate that a call is malicious and that identification and registration of its source is requested. It may be included in an EEM or LLM, sent in the backward direction after answer.

On receipt of such an indication a PBX may, for example:

- record call details for later examination by appropriate authorities, including:
 - time of call;
 - identities of calling and connected lines and parties;
 - dialled number;
 - Malicious Call Reference (if provided);
- relay a corresponding indication to another network (eg a public network);
- raise an alert (eg alarm indication) to an operator;
- prevent the call from being released;
- protect the call from interruption or disconnection by other services (eg Intrusion, Breakdown, Route Optimisation).

Use of the String in an LLM enables each PBX in a call path to record call details and/or protect the call from interruption.

An EEM can be used when Transit PBXs are not required to take any action.

If MCI is included in an LLM, receipt of an LLM containing IG-SNU will indicate when MCI has not been understood by a Transit PBX; receipt of an LLM containing SNU will indicate that MCI has not been understood by the End PBX.

If MCI is included in an EEM, receipt of an EEM containing SNU will indicate that MCI has not been understood by the End PBX.

3.28.2 String Parameters

3.28.2.1 Malicious Call Reference

This Parameter is an IA5 numeric character sequence comprising up to 3 digits for identifying a request to trace a malicious call in a DPNSS 1 network.

This Parameter is optional. It may be omitted if Malicious Call References are not used.

3.29 INTERIM ANSWER (INT-A)

3.29.1 String Definition

This string may be sent in a CCM to indicate to the Originating PBX that an answer indication should be given to the originating party in advance of the called party actually answering. A typical application of this would be to accompany the connection of an announcement given when the Terminating PBX has queued a call for a busy party and where an Originating Gateway PBX would need to generate an answer signal to another network such as the PSTN in order to ensure that the announcement would be heard.

On receipt of a CCM containing INT-A, an answer signal shall be given to the calling party (where such a signal is defined), and the Originating PBX shall ensure that a transmission path is established between the calling party and the DPNSS 1 channel, at least in the backward direction. The Originating PBX shall then continue in the same state as if the CCM containing INT-A had not been received, insofar as it shall be prepared to act upon supplementary service requests received from the Terminating PBX that are relevant to the awaiting answer state (such as a Divert on Ring No Reply request) and accept a further CCM from the Terminating PBX to indicate answer by the called party. In addition, the Originating PBX may itself still invoke supplementary services relevant to the awaiting answer state (eg Redirection).

A CCM is used to convey INT-A to ensure that a PBX which does not recognise INT-A will still generate an answer signal to the originating party. Receipt of an EEM containing IG-SNU indicating that INT-A has not been recognised can be interpreted by the sending PBX to mean that the CCM has been acted on in the normal manner and that the Originating PBX is no longer in the waiting for answer state.

A PBX that has sent a CCM containing INT-A shall send a further CCM on answer by the called party, unless it has received an indication that INT-A has not been recognised in which case sending the further CCM is optional. The receipt of an indication that INT-A has not been recognised may also be used to suppress any supplementary service requests that are only relevant to the waiting for answer state (eg a Divert On No Reply request). The contents of the first and second CCM sent by the Terminating PBX should be as similar as possible (with the exception of the inclusion of INT-A) to cater for the case where the Originating PBX does not recognise INT-A (and so ignores the second CCM).

3.29.2 String Parameters

None.

3.30 ROUTE OPTIMISATION INVITE (ROP-INV)

3.30.1 String Definition

This string is used to request that the Route Optimisation procedures defined in Section 19 be invoked. ROP-INV may be sent in a NIM or an EEM to the PBX required to act as the Originating PBX. A NIM is used if the invitation needs to be sent during the routing phase of a call, an EEM is used if the invitation needs to be sent after the routing phase has been completed (either before or after answer).

On receipt of ROP-INV, the receiving PBX may invoke Route Optimisation as described in Paragraph 2.3.1.1 of Section 19 once the call has reached an appropriate state.

3.30.2 String Parameters

None.

3.31 PUBLIC CALLING PARTY NUMBER - PROVIDED (PCLG-P)

3.31.1 String Definition

This String is used to inform a public network Gateway PBX of the public calling party number to be sent on behalf of the calling extension.

PCLG-P may be sent in any ISRM/RM/ERM sequence to convey the calling party number to be generated by an outgoing Gateway PBX (if encountered).

PCLG-P may convey the public network identity of the calling extension, or some other appropriate (e.g. non-geographical) number. Where PCLG-P is received, the number conveyed shall be used in preference to any number that could be derived from the OLI of the calling extension.

Where the route to the public network is not ISDN, but the route is still able to convey calling party number, the contents of the PCLG-P String may be used to derive the appropriate indication for the signalling system encountered.

3.31.2 String parameters

3.31.2.1 ISDN Number Attributes

This parameter conveys the octet 3 group (octets 3, 3a, etc) of an ISDN calling party number information element.

3.31.2.2 ISDN Number digits

This parameter conveys the number digits (octet 4 and any repetitions) of an ISDN calling party number information element.

3.32 PUBLIC CALLING PARTY NUMBER - DEFAULT (PCLG-D)

3.32.1 String Definition

This String is used to inform a public network Gateway PBX that the called party in the public network should receive a default calling party number, irrespective of whether or not it is possible to derive a calling party number from the OLI of the calling extension.

PCLG-D may be sent in any ISRM/RM/ERM sequence to indicate to an outgoing Gateway PBX (if encountered) that a default calling party number is required.

The means by which a default calling party number is provided to the party in the public network is dependent on the design of the Gateway PBX and/or the services available in the public network to which the Gateway PBX is connected. It may be achieved either by sending a calling party number stored at the Gateway PBX, or by sending no calling party number in order to cause the public network to provide a default of its own.

3.32.2 String parameters

None.

3.33 PUBLIC CONNECTED NUMBER - PROVIDED (PCON-P)

3.33.1 String Definition

This String is used to inform a public network Gateway PBX of the public connected number to be sent on behalf of the answering extension.

PCON-P may be sent in a CCM, or in an EEM sent immediately prior to the CCM, to convey the connected number to be generated by the incoming Gateway PBX.

PCON-P may convey the public network identity of the answering extension, or some other appropriate (e.g. non-geographical) number. Where PCON-P is received, the number conveyed shall be used in preference to any number that could be derived from the CLI of the answering extension. If PCON-P is received in an EEM, its contents shall be saved and acted on when the CCM is received.

Where the route from the public network is not ISDN, but the route is still able to convey connected number, the contents of the PCON-P String may be used to derive the appropriate indication for the signalling system encountered.

3.33.2 String parameters

3.33.2.1 ISDN Number Attributes

This parameter conveys the octet 3 group (octets 3, 3a, etc) of an ISDN connected number information element.

3.33.2.2 ISDN Number digits

This parameter conveys the number digits (octet 4 and any repetitions) of an ISDN connected number information element.

3.34 PUBLIC CONNECTED NUMBER - DEFAULT (PCON-D)

3.34.1 String Definition

This String is used to inform a public network Gateway PBX that the calling party in the public network should receive a default connected number, irrespective of whether or not it is possible to derive a connected number from the CLI of the answering extension.

PCON-D may be sent in a CCM, or in an EEM sent immediately prior to the CCM, to indicate to the incoming Gateway PBX that a default connected number is required. If PCON-D is received in an EEM, its contents shall be saved and acted on when the CCM is received.

The means by which a default connected number is provided to the party in the public network is dependent on the design of the Gateway PBX and/or the services available in the public network to which the Gateway PBX is connected. It may be achieved either by sending a connected number stored at the Gateway PBX, or by sending no connected number in order to cause the public network to provide a default of its own.

3.34.2 String parameters

None.

4 COMPLIANCE SHEET FOR SERVICE-INDEPENDENT STRINGS

The use of Service-Independent Strings is optional in DPNSS 1 and their provision on a PBX is a matter for negotiation between a customer and his supplier (see FOREWORD in SECTION 0 of this specification). This subsection may be used as an aid to those negotiations.

Compliance with SECTION 16 is considered in terms of the function(s) to be performed by the PBX (ie Transit, End or Branching) and the extent to which the PBX can send or act upon each of the Strings.

The options available are given in TABLES 1 to 3. These tables should be completed by a manufacturer to indicate the PBX capability and by a purchaser to indicate PBX requirements.

TABLE 1 should be ticked to indicate which function(s) the PBX is able/required to perform in the use of these Strings in the network.

TABLES 2 and 3 should be completed as required to indicate the service options that are required/provided by the function. Where "YES" is pre-printed in a table it indicates that the feature is a mandatory part of the service.

TABLE 1

PBX FUNCTION		APPLICABLE TABLE
PBX supporting the use of Service-Independent Strings.		TABLE 2
Transit PBX		TABLE 3

TABLE 2

COMPLIANCE TABLE FOR A PBX THAT SUPPORTS SERVICE INDEPENDENT STRINGS		
SERVICE VARIANT		COMMENT
Able to send a Class of Service String?		
Able to act upon a Class of Service String?		Specify action taken
Able to send a Hunt Group Forwarded String?		
Able to act upon a Hunt Group Forwarded String?		Specify action taken
Able to send a Satellite Barred String?		
Able to prohibit access to links using a satellite on receipt of a Satellite Barred String?		
Able to send a Direct Route Select String?		
Able to route a call according to a Direct Route Select String?		
Able to send a Textual Display String?		
Able to display text received in a Textual Display String?		
Able to send an Intercom Call String?		
Able to act upon an Intercom Call String?		Specify action taken
Able to send a Queue Information String?		
Able to act upon a Queue Information String?		Specify action taken

TABLE 2 (CONTINUED)

COMPLIANCE TABLE FOR A PBX THAT SUPPORTS SERVICE INDEPENDENT STRINGS		
SERVICE VARIANT		COMMENT
Able to send a Password String?		Specify services
Able to restrict access to services upon receipt of a Password String?		Specify services
Able to send a Service Information String?		
Able to act upon a Service Information String?		Specify action taken
Able to send a Trunk Identity String?		
Able to act upon a Trunk Identity String?		Specify action taken
Able to send Supplementary Facilities Inhibited String?		
Able to inhibit the use of facilities upon receipt of a Supplementary Facilities Inhibited String?		Specify Facilities
Able to send an Auto Answer String?		
Able to act upon an Auto Answer String?		Specify action taken
Able to send a Hands Free-Activated String?		
Able to act upon a Hands Free-Activated String?		Specify action taken
Able to send a Hands Free-Deactivated String?		
Able to act upon a Hands Free-Deactivated String?		Specify action taken
Able to send a DASS 2 Service Indicator Code String		
Able to act upon a DASS 2 Service Indicator Code String		Specify action taken

TABLE 2 (CONTINUED)

COMPLIANCE TABLE FOR A PBX THAT SUPPORTS SERVICE INDEPENDENT STRINGS		
SERVICE VARIANT		COMMENT
Able to send a Device Identity String?		
Able to act upon a Device Identity String?		Specify action taken
Able to send NAE Calling/Called Identity Strings?		
Able to act upon NAE Calling/Called Identity Strings?		Specify action taken
Able to send an Internal Reroute Disabled String		Specify when
Able to act upon an Internal Reroute Disabled String?		
Able to send an External Reroute Disabled String?		Specify when
Able to act upon an External Reroute Disabled String?		
Able to send a Queueing Priority String?		Specify when
Able to act upon a Queueing Priority String?		
Able to send a VPN Initiated Clear String?		Public Network nodes only
Able to act upon a VPN Initiated Clear String?		Specify action taken
Able to send an Assistance Information String?		
Able to act upon an Assistance Information String?		Specify action taken
Able to send an Auxiliary Route Restriction Class String?		
Able to act upon an Auxiliary Route Restriction Class String?		Specify action taken

TABLE 2 (CONTINUED)

COMPLIANCE TABLE FOR A PBX THAT SUPPORTS SERVICE INDEPENDENT STRINGS		
SERVICE VARIANT		COMMENT
Able to send a Redirection Control String?		Specify when
Able to act upon a Redirection Control String?		Specify circumstances
Able to send a Message Index String?		
Able to act upon a Message Index String?		Specify action taken
Able to send a VPN-Nodal Identity String?		Public Network nodes only
Able to act upon a VPN-Nodal Identity String?		Public Network nodes only
Able to send a Network Signalling Limit String?		
Able to act upon a Network Signalling Limit String?		Specify action taken
Able to send a Malicious Call Indication String in response to a user request?		
Able to act upon a Malicious Call Indication String in an EEM and LLM?		Specify action taken
Able to send an Interim Answer String?		Specify when
Able to act upon an Interim Answer String?		Specify action taken
Able to send a Route Optimisation Invite String?		Specify when
Able to act upon a Route Optimisation Invite String?		
Able to send a Public Calling Party Number - Provided String?		Specify when

TABLE 2 (CONTINUED)

COMPLIANCE TABLE FOR A PBX THAT SUPPORTS SERVICE INDEPENDENT STRINGS		
Able to act upon a Public Calling Party Number - Provided String?		
Able to send a Public Calling Party Number - Default String?		Specify when
Able to act upon a Public Calling Party Number - Default String?		Specify action taken
Able to send a Public Connected Number - Provided String?		Specify when
Able to act upon a Public Connected Number - Provided String?		
Able to send a Public Connected Number - Default String?		Specify when
Able to act upon a Public Connected Number - Default String?		Specify action taken

TABLE 3

COMPLIANCE TABLE FOR A TRANSIT PBX IN A NETWORK THAT SUPPORTS SERVICE INDEPENDENT STRINGS		
SERVICE VARIANT		COMMENT
Able to act as a transit for Service Independent Strings?	YES	Inherent DPNSS 1 capability
Able to act upon Class Of Service String?		Specify action taken
Able to act upon Direct Route Select String?		
Able to insert a Satellite Barred String?		
Able to act upon a Satellite Barred String?		
Able to insert an Internal Reroute Disabled String?		Specify when
Able to act upon an Internal Reroute Disabled String?		
Able to insert an External Reroute Disabled String?		Specify when
Able to act upon an External Reroute Disabled String?		
Able to act upon a Malicious Call Indication String in an LLM		Specify action taken

DIGITAL PRIVATE NETWORK SIGNALLING SYSTEM NO 1 (DPNSS 1)

SECTION 17 - SUPPLEMENTARY SERVICE : CALL WAITING

CONTENTS

1	GENERAL	Page 2
2	CALL WAITING BETWEEN ORDINARY EXTENSIONS WITHIN DPNSS 1	Page 3
2.1	DEFINITION.....	Page 3
2.2	DESCRIPTION.....	Page 3
2.3	OUTLINE OF OPERATION.....	Page 3
2.3.1	Call Waiting Requested by Wanted Party accepted by Clear.....	Page 4
	Call Waiting Requested by Wanted Party accepted by Hold.....	Page 5
2.3.2	Call Waiting Converted to Executive Intrusion.....	Page 8
3	COMPLIANCE	Page 10

HISTORY

Issue 1 - February 1984
Issue 2 - September 1984
Issue 3 - March 1986
Issue 4 - December 1989

Issue 5 - March 2001 - Specification renamed as DPNSS[188]

1 GENERAL

1.1 This Section details the signalling requirements of DPNSS 1 for the Call Waiting Supplementary Service.

1.2 Subsection 2 details the service within DPNSS 1.

1.3 Subsection 3 shows the Compliance.

1.4 The description is given in the form of Message Sequence Diagrams (MSDs) followed by explanatory text.

1.5 The text is referenced from MSDs at appropriate points in the sequences.

1.6 Message contents for successful calls are shown in MSDs. Messages and their contents for alternative sequences (eg for unsuccessful calls) are detailed in the text.

1.7 Coding of the contents of messages is given in SECTION 4.

2 CALL WAITING BETWEEN ORDINARY EXTENSIONS WITHIN DPNSS 1

2.1 DEFINITION

The Call Waiting Supplementary Service (CW) enables an extension user to request that an indication be given if an incoming call arrives while the extension is busy on another call.

As an option, the calling party may convert from waiting on the call to Executive Intrusion on the call.

2.2 DESCRIPTION

A user engaged on an existing call is given an indication (Call Waiting Indication) that another call is incoming to his line, whilst the calling party is given an audible indication that Call Waiting Indication is being applied to the wanted extension. The wanted party is then given the choice of:

- i. Going on-hook and being automatically re-rung;
- ii. Holding the existing call and answering the new call;
- iii. Rejecting the Call Waiting Indication;
- iv. Ignoring the waiting call.

The Call Waiting service is a wanted-party service.

The registration and cancellation of the service is carried out within the PBX and does not involve DPNSS 1 signalling.

2.3 OUTLINE OF OPERATION

The Call Waiting service is provided by the following signal sequences:

2.3.1 Call Waiting Requested by the Wanted Party: Accepted by Clear

Call Waiting Requested by the Wanted Party: Accepted by Hold

2.3.2 Call Waiting: Converted to Executive Intrusion

2.3.1 CALL WAITING REQUESTED BY WANTED PARTY ACCEPTED BY CLEAR

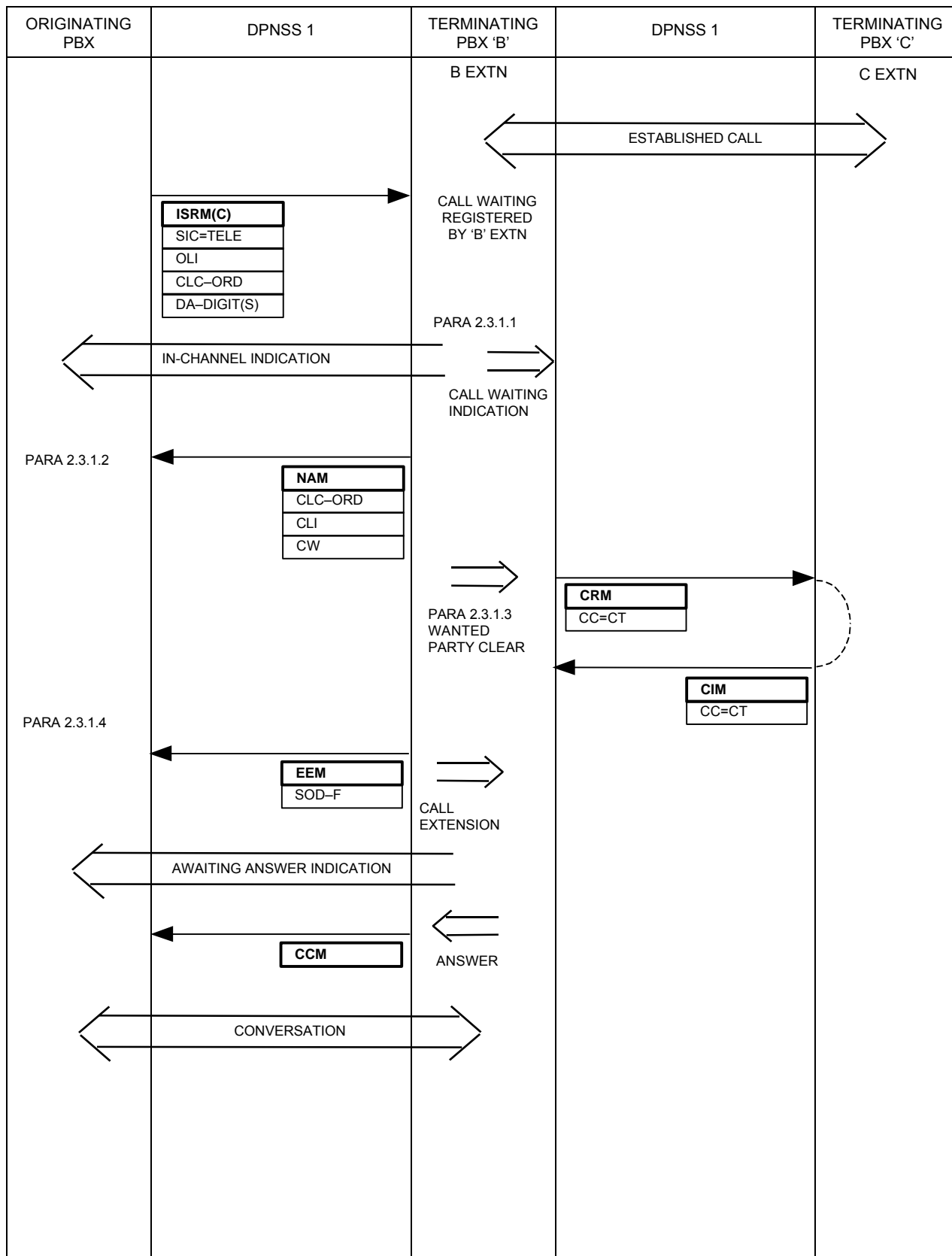

2.3.1 CALL WAITING REQUESTED BY WANTED PARTY ACCEPTED BY HOLD

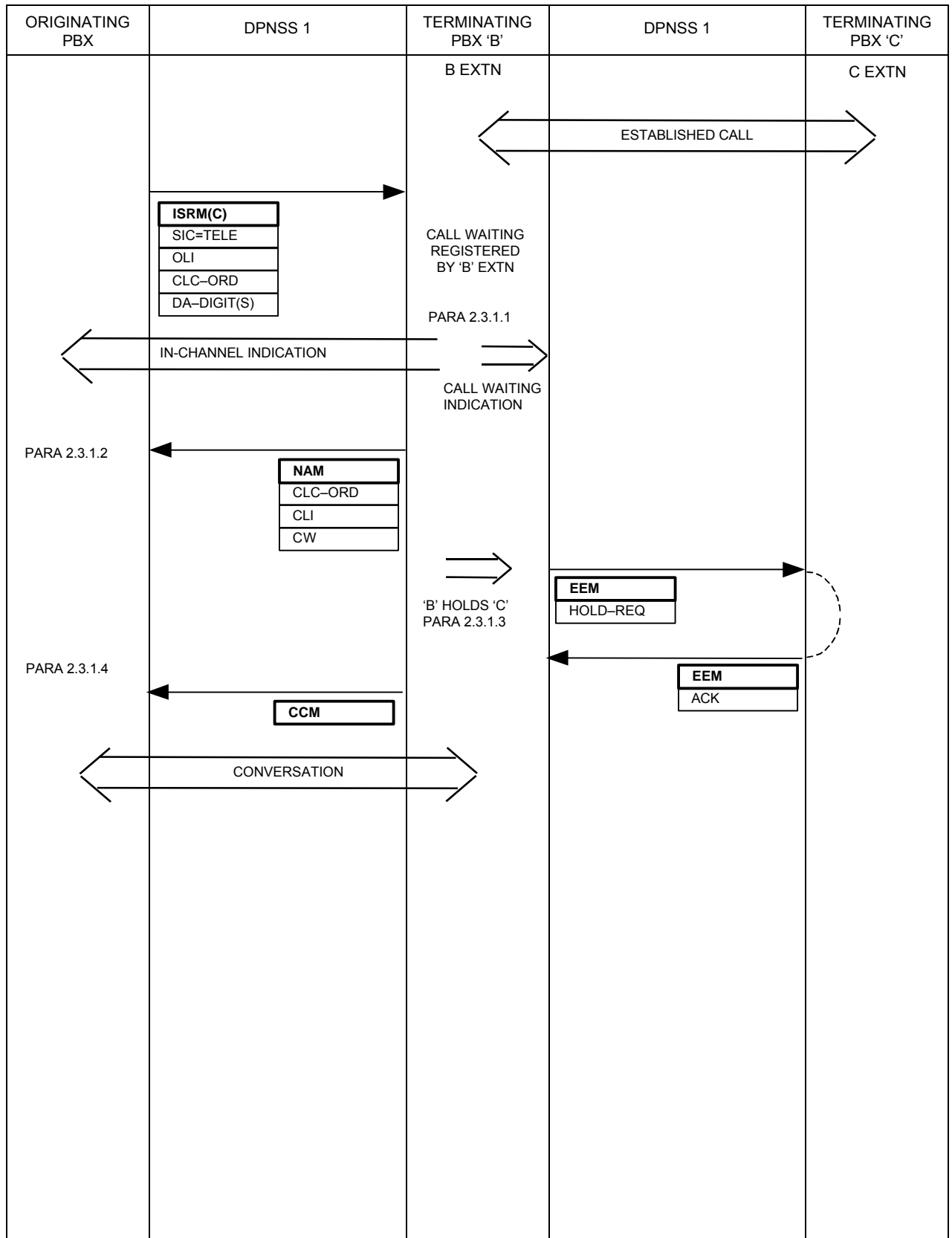

2.3.1.1 When sufficient digits have been received from an ISRM and/or SSRMs to determine that the call is to an extension which has Call Waiting registered on it and is busy, Call Waiting Indication shall be applied to the called extension. The calling party shall be given an in channel indication that Call Waiting Indication is being applied, and a NAM containing the Called Line Category, Called Line Identity, and Call Waiting (CW) shall be returned to the Originating PBX.

2.3.1.2 If, on receipt of the NAM indicating the Call Waiting service, the Originating PBX wishes to reject it, a CRM containing the Clearing Cause: Service Unavailable (SU) shall be sent, and a CIM expected in response. Busy Indication shall be applied to the calling extension.

2.3.1.3 The party receiving the Call Waiting Indication may accept the call by either clearing the existing call or placing the existing call on Hold. If the wanted party clears, a CRM shall be sent to the unwanted party, as for a Simple Call clear-down sequence, and an EEM containing SOD-F shall be sent to the Originating PBX on the signalling channel.

The wanted party shall be re-called and the waiting call treated as a Simple Call.

If the wanted party places the existing call on Hold and accepts the waiting call, a CCM shall be sent to the Originating PBX. A transmission path between the calling and wanted parties shall be established. If the existing call is to an extension on another DPNSS 1 PBX the Hold Supplementary Service procedure may be applied (see SECTION 12 of this specification). Where the PBX supports the Three-Party Service further Three-Party procedures may be possible after acceptance of the Waiting call.

If the caller clears without the call being completed, a CRM containing the Clearing Cause : Call Termination (CT) shall be sent on the signalling channel and a CIM expected in response.

If the Call Waiting Indication is ignored by the called party for a configurable time-out period (eg 30 ± 1 seconds), the wanted party's PBX shall send a CRM containing Clearing Cause: Network Termination (NT) on the signalling channel and shall expect a CIM in response.

If Call Waiting Indication is rejected by the called party, a CRM containing the Clearing Cause: Reject (REJ) shall be sent on the signalling channel and a CIM shall be expected in response. If Call Waiting Indication is being applied to the wanted extension, it shall be removed.

If the waiting call is actively rejected by the wanted party, Call Waiting may, optionally, be deactivated for the remainder of the established call.

2.3.1.4 If a CRM containing Clearing Cause: NT is received, a CIM shall be sent in response and busy indication applied to the calling extension.

If a CRM containing Clearing Cause: REJ is received, a CIM shall be sent in response and an appropriate indication applied to the calling extension.

If the caller clears without the call being completed, a CRM containing Clearing Cause: Call Termination (CT) shall be sent to the wanted party's PBX and a CIM shall be expected in response. If Call Waiting Indication is being applied to the wanted extension, it shall be removed.

2.3.2 CALL WAITING – CONVERTED TO INTRUSION

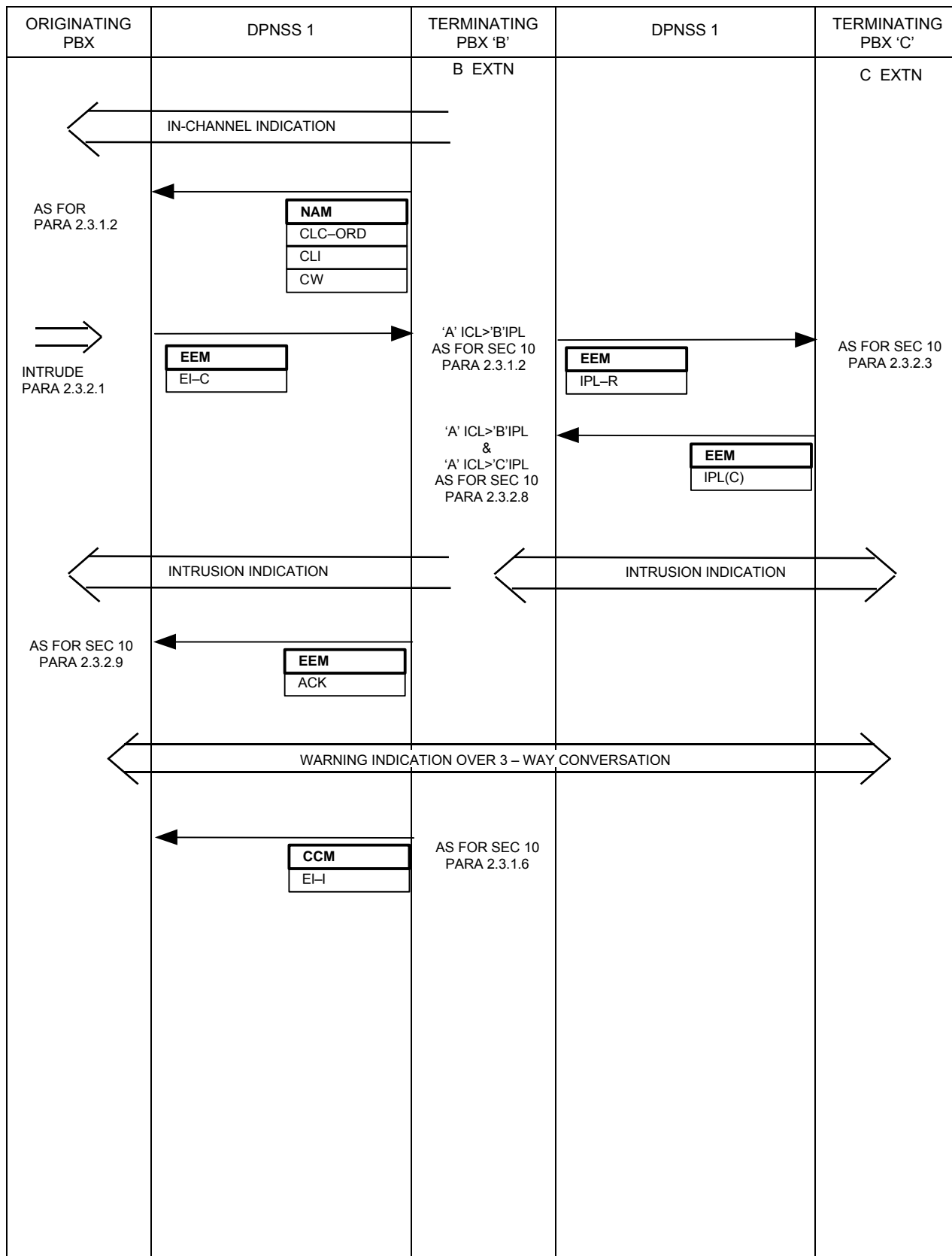

2.3.2.1 If the originating party requests Intrusion after receipt of the indication that the call is waiting at the wanted party's PBX, an EEM containing the String, "Executive Intrusion-Convert (EI-C)" shall be sent by the Originating PBX to the wanted party's PBX. The Parameter to the EI-C String is the requesting party's Intrusion Capability Level (ICL).

2.3.2.2 On receipt of the EEM containing the EI-C String when the wanted extension is still busy and intrudable, the IPL of the unwanted extension shall be requested using the sequence described in SECTION 10 paragraphs 2.3.2.2 to 2.3.2.4.

If, after checking the intrudable states of the wanted and unwanted parties, at the wanted party's PBX, it is determined that Intrusion can not take place, an EEM containing REJ shall be returned to the Originating PBX and the waiting state maintained.

If Intrusion is permitted, waiting indications shall be removed by the wanted party's PBX, Intrusion Indication applied, and the call shall be completed as described in SECTION 10, paragraph 2.3.2.8 for a successful Intrusion.

Since Conversion to Executive Intrusion is an optional part of this Service, a PBX not offering the option will treat the EI-C String as unrecognised and return an EEM containing String SNU to the Originating PBX and leave the call in the waiting state.

2.3.2.3 If, in response to the EEM containing EI-C, the requesting PBX receives an EEM containing ACK, this signifies that the Intrusion is proceeding (as described in SECTION 10, paragraph 2.3.2.9).

If an EEM containing REJ or SNU is received, an appropriate indication may be given to the requesting party and the call shall remain in the waiting state.

3 COMPLIANCE SHEETS FOR SUPPLEMENTARY SERVICE: CALL WAITING

The Call Waiting Supplementary Service is an optional part of DPNSS 1 and its provision on a PBX is a matter for negotiation between a customer and his supplier (see FOREWORD in SECTION 0 of this specification). This Subsection may be used as an aid to those negotiations.

NOTE: Whilst the provision of this service is optional, if it is provided, compliance with certain features of the service becomes mandatory.

Compliance with the service is considered in terms of the function(s) to be performed by the PBX , ie Transit, End or Branching, and the extent to which extensions on the PBX can request the service.

The options available are given in TABLE 1. This table should be completed by a manufacturer to indicate PBX capability and by a purchaser to indicate PBX requirements.

TABLES 2 to 4 indicate the features that are required at each PBX. The pre-printed "YES" indicates that the feature is a mandatory part of the service for that PBX function.

TABLE 1

PBX FUNCTION		APPLICABLE TABLE
PBX with extensions, some of which can request the service.		TABLES 2 & 3
PBX with extensions, none of which can request the service.		TABLE 2
Transit PBX		TABLE 4

TABLE 2

COMPLIANCE TABLE FOR A PBX WITH OPERATORS OR EXTENSIONS IN A NETWORK THAT SUPPORTS CALL WAITING		
SERVICE VARIANT		COMMENT
Able as an Outgoing PBX to respond correctly when it receives a Call Waiting Indication from a called extension on another DPNSS 1 PBX? (The call may be accepted by the called extension either by clearing or placing the existing call on hold.)	YES	
Able, in a Call Waiting situation, to request Conversion to Executive Intrusion?		

TABLE 3

ADDITIONAL COMPLIANCE TABLE FOR A PBX WITH EXTENSIONS THAT ARE ABLE TO REGISTER CALL WAITING		
SERVICE VARIANT		COMMENT
Able to indicate to an incoming call from another DPNSS 1 PBX that the Call Waiting Service is registered on the required extension?	YES	
Able to accept the incoming call by clearing?		
Able to accept the incoming call by placing the existing call on Hold?		
Able to indicate to the caller that the extension has rejected the call?		
Able, in a Call Waiting situation, to accept a request to convert to Executive Intrusion?		

TABLE 4

COMPLIANCE TABLE FOR A TRANSIT PBX IN A NETWORK THAT SUPPORTS CALL WAITING		
SERVICE VARIANT		COMMENT
Able to transit a call that encounters Call Waiting?	YES	Inherent DPNSS 1 capability
Able to transit Executive Intrusion-Conversion Requests?	YES	Inherent DPNSS 1 capability

DIGITAL PRIVATE NETWORK SIGNALLING SYSTEM NO 1 (DPNSS 1)

SECTION 18 - SUPPLEMENTARY SERVICE : BEARER-SERVICE SELECTION

CONTENTS

1	GENERAL	Page 2
2	BEARER-SERVICE SELECTION WITHIN DPNSS 1	Page 3
2.1	DEFINITION.....	Page 3
2.2	DESCRIPTION.....	Page 3
2.3	OUTLINE OF OPERATION.....	Page 4
2.3.1	BSS-M : Mandatory.....	Page 4
2.3.2	BSS-P : Preferred.....	Page 4
2.3.3	BSS-N : Notification.....	Page 5
3	COMPLIANCE	Page 6

HISTORY

Issue 1 - February 1984
Issue 2 - September 1984
Issue 3 - March 1986
Issue 4 - December 1989
Issue 5 - January 1995

Issue 6 - March 2001 - Specification renamed as DPNSS[188]

1 GENERAL

1.1 This Section details the signalling requirements of DPNSS 1 for the Bearer-Service Selection Supplementary Service.

1.2 Subsections 2 details the service within DPNSS 1.

1.3 Subsection 3 shows the Compliance.

1.4 No extra signalling, beyond that in SECTION 5 for rejection of Supplementary Services, is involved, so no Message Sequence Diagrams are given in this Section.

1.5 Coding of the contents of messages is given in SECTION 4.

2 BEARER-SERVICE SELECTION WITHIN DPNSS 1

2.1 DEFINITION

The Bearer-Service Selection (BSS) Supplementary Service permits selection of particular bearer service(s) or transmission capacity where the call anticipates requirements for a bearer service that might not otherwise be provided by a Transit PBX on the basis of the given SIC.

2.2 DESCRIPTION

This service is normally requested in the set-up phase of a call, though as a Supplementary Service it may occur in other messages.

2.2.1 A PBX must allocate an outgoing route adequate to carry the service specified in the SIC. If the originator of the call anticipates that the required service may be changed after setup (by use of a Swap Message) such that normal selection of an outgoing route based on the SIC may not provide an adequate bearer for the new service, then it may use the BSS Supplementary Service to indicate its future requirements.

The BSS String contains a single Parameter which is an encoded SIC from the list shown in SECTION 4, ANNEX 1. The use of an encoded SIC for the anticipated service, instead of specifying the bit rate of the required channel, eg 8 kbit/s, is more appropriate for mixed analogue/digital networks, and allows, for example, the use of a suitable data modem on an analogue link. The Parameter shall be an encoded binary number as described in SECTION 4, ANNEX 2.

A Transit PBX shall provide an onward route adequate to carry either the service specified by the SIC at the front of the ISRM or the service specified in the BSS String; usually, the BSS String will indicate a higher data-rate requirement, and so will determine the choice of onward route.

For example, a call may start with SIC=Telephony but have BSS=64 kbit/s synchronous data. This indicates to Transit PBXs that although the call is telephony, it should be routed only over 64 kbit/s transparent paths.

Any non-intrudability attribute of the SIC in the ISRM is not overridden by a BSS String; if a call starts as intrudable but a non-intrudable service is indicated in the BSS String, then the call is intrudable until a Swap Message changes to a non-intrudable Service (and vice versa).

There are three variations of Bearer-Service Selection:

Mandatory, Preferred and Notification.

These variations will be encoded using the three identifiers: BSS-M, BSS-P and BSS-N.

2.3 OUTLINE OF OPERATION

2.3.1 BSS-M : Mandatory

This is for use when, either by user action (eg a special button) or by a class marking on the terminal, it is known in advance that the call will require a change of service.

An example of this is a voice/text messaging service, where a user wishes to store a message consisting of both voice and data messages.

For the Mandatory version of the service, a call shall fail unless a channel can be provided which is suitable for both the SIC in the ISRM and the SIC in the BSS String. If the call fails because a channel suitable for the SIC in the BSS String cannot be provided, the call shall be cleared by a CRM or RRM containing a Clearing or Rejection Cause: Service Unavailable (SU) and the Supplementary Information String SU.

2.3.2 BSS-P : Preferred

This is for use when, either by user action (eg a special button) or by a class marking on the terminal, it is known in advance that the call will probably require a change of service but should not be failed if the subsequent service will not be possible.

An example of this is when one user on a terminal marked as 'voice/data' wishes to call another and would prefer to be able to switch to data during a voice call to send a sketch drawing, but would rather have a voice-only call than no call at all. The returned NIM containing IG-SU may be used to give an indication to the user of whether a swap to data will be possible.

For the Preferred version of the service, a channel suitable for the SIC in the ISRM must be provided. This channel should, if possible, also be suitable for the SIC in the BSS String; if it is not, the call should proceed and the Originating PBX should be notified using a NIM containing IG-SU.

2.3.3 BSS-N : Notification

This is the normal mode when a user makes a call from a terminal that is capable of voice/data operation but has not indicated any intention of swapping. It is important that Transit PBXs should not attempt to satisfy the service indicated in BSS because this could prematurely use up all of the high-grade circuits.

This type of BSS is used on most calls from voice/data terminals which have the capability of indicating to the user that a swap to data is, or is not, possible.

An example is when a user wishes to make an ordinary telephone call from a voice/data terminal: if a Transit PBX has both analogue and digital links towards the destination, it is more economical to route the telephone call over analogue. The Originating PBX would use BSS-N when, for example, the originating terminal has an l.e.d. display to indicate whether or not a swap to data will be possible.

For the Notification version of the service, a channel suitable for the SIC in the ISRM must be provided, but no preference for a channel suitable for the SIC in the BSS String is implied. If the channel provided is not suitable for the SIC in the BSS String, the Originating PBX should be notified using a NIM containing IG-SU.

3 COMPLIANCE SHEETS FOR SUPPLEMENTARY SERVICE: BEARER-SERVICE SELECTION

The Bearer-Service Selection Supplementary Service is an optional part of DPNSS 1 and its provision on a PBX is a matter for negotiation between a customer and his supplier (see FOREWORD in SECTION 0 of this specification). This Subsection may be used as an aid to those negotiations.

NOTE: Whilst the provision of this service is optional, if it is provided, compliance with certain features of the service becomes mandatory.

Compliance with the service is considered in terms of the function(s) to be performed by the PBX, ie Transit, End or Branching, and the extent to which operators or extensions on the PBX can request the service.

The Bearer-Service Selection Service is split into three types:

- Bearer-Service Selection: Mandatory;
- Bearer-Service Selection: Preferred, and
- Bearer-Service Selection: Notification.

The Compliance Tables are allocated a separate Subsection for each type of Bearer-Service Selection.

TABLE 0 should be completed by a manufacturer to indicate PBX capability and by a purchaser to indicate PBX requirements.

TABLE 0

SERVICE		APPLICABLE SUBSECTION OF COMPLIANCE SHEETS
Bearer-Service Selection: Mandatory		3.1
Bearer-Service Selection: Preferred		3.2
Bearer-Service Selection: Notification		3.3

3.1 COMPLIANCE SHEETS FOR BEARER-SERVICE SELECTION: MANDATORY

The options available are given in TABLE 1. This table should be completed by a manufacturer to indicate PBX capability and by a purchaser to indicate PBX requirements.

TABLES 2 and 3 indicate the features that are required/provided at each PBX. The pre-printed "YES" indicates that the feature is a mandatory part of the service for that PBX function.

TABLE 1

PBX FUNCTION		APPLICABLE TABLE
PBX with operators or extensions, some of which can request the service.		TABLE 2
Transit PBX		TABLE 3

TABLE 2

COMPLIANCE TABLE FOR A PBX WITH OPERATORS OR EXTENSIONS THAT ARE ABLE TO REQUEST BEARER-SERVICE SELECTION: MANDATORY		
SERVICE VARIANT		COMMENT
Able to use Bearer-Service Selection Mandatory(BSS-M) to request specific transmission path capabilities on outgoing calls?		

TABLE 3

COMPLIANCE TABLE FOR A TRANSIT PBX THAT SUPPORTS BEARER - SERVICE SELECTION: MANDATORY		
SERVICE VARIANT		COMMENT
Able to select a transmission path for the onward routing of a call based on the Bearer-Service requirements (BSS-M) included in a received ISRM or RM?	YES	

3.2 COMPLIANCE SHEETS FOR BEARER-SERVICE SELECTION: PREFERRED

The options available are given in TABLE 1. This table should be completed by a manufacturer to indicate PBX capability and by a purchaser to indicate PBX requirements.

TABLES 2 and 3 indicate the features that are required/provided at each PBX. The pre-printed "YES" indicates that the feature is a mandatory part of the service for that PBX function.

TABLE 1

PBX FUNCTION		APPLICABLE TABLE
PBX with operators or extensions, some of which can request the service.		TABLE 2
Transit PBX		TABLE 3

TABLE 2

COMPLIANCE TABLE FOR A PBX WITH OPERATORS OR EXTENSIONS THAT ARE ABLE TO REQUEST BEARER-SERVICE SELECTION: PREFERRED		
SERVICE VARIANT		COMMENT
Able to use Bearer-Service Selection: Preferred (BSS-P) to request specific transmission path capabilities on outgoing calls?		

TABLE 3

COMPLIANCE TABLE FOR A TRANSIT PBX THAT SUPPORTS BEARER-SERVICE SELECTION: PREFERRED		
SERVICE VARIANT		COMMENT
Able to select a transmission path for the onward routing of a call based on the Bearer-Service requirements (BSS-P) included in a received ISRM or RM?	YES	

3.3 COMPLIANCE SHEETS FOR BEARER-SERVICE SELECTION: NOTIFICATION

The options available are given in TABLE 1. This table should be completed by a manufacturer to indicate PBX capability and by a purchaser to indicate PBX requirements.

TABLES 2 and 3 indicate the features that are required/provided at each PBX. The pre-printed "YES" indicates that the feature is a mandatory part of the service for that PBX function.

TABLE 1

PBX FUNCTION		APPLICABLE TABLE
PBX with operators or extensions, some of which can request the service.		TABLE 2
Transit PBX		TABLE 3

TABLE 2

COMPLIANCE TABLE FOR A PBX WITH OPERATORS OR EXTENSIONS THAT ARE ABLE TO REQUEST BEARER-SERVICE SELECTION: NOTIFICATION		
SERVICE VARIANT		COMMENT
Able to use Bearer-Service Selection: Notification (BSS-N) to request specific transmission path capabilities on outgoing calls?		

TABLE 3

COMPLIANCE TABLE FOR A TRANSIT PBX THAT SUPPORTS BEARER - SERVICE SELECTION: NOTIFICATION		
SERVICE VARIANT		COMMENT
Able to select a transmission path for the onward routing of a call based on the Bearer-Service requirements (BSS-N) included in a received ISRM or RM?	YES	

DIGITAL PRIVATE NETWORK SIGNALLING SYSTEM NO 1 (DPNSS 1)

SECTION 19 - SUPPLEMENTARY SERVICE: ROUTE OPTIMISATION

CONTENTS

1	GENERAL	Page 2
2	ROUTE OPTIMISATION WITHIN DPNSS 1	Page 3
2.1	DEFINITION.....	Page 3
2.2	DESCRIPTION.....	Page 3
2.3	OUTLINE OF OPERATION.....	Page 4
2.3.1	Route Optimisation - Retention of None of the Existing Path.....	Page 5
2.3.2	Route Optimisation - Retention of Part of the Existing Path.....	Page 9
2.3.3	Route Optimisation - Retention of All of the Existing Path.....	Page 11
2.3.4	Route Optimisation - Acknowledged Invitation to invoke Route Optimisation.	Page 12
3	COMPLIANCE	Page 13

HISTORY

Issue 1 - September 1984
Issue 2 - March 1986
Issue 3 - December 1989

Issue 4 - March 2001 - Specification renamed as DPNSS[188]
- Acknowledged Invitation to invoke
Route Optimisation added

1 GENERAL

- 1.1** This Section details the signalling requirements of DPNSS 1 for the Route Optimisation Supplementary Service.
- 1.2** Subsection 2 details the service within DPNSS 1.
- 1.3** Subsection 3 shows the Compliance.
- 1.4** The description is given in the form of Message Sequence Diagrams (MSDs) followed by explanatory text.
- 1.5** The text is referenced from MSDs at appropriate points in the sequence.
- 1.6** Message contents for successful Route Optimisation sequences are shown in MSDs. Messages and their contents for alternative sequences (eg where a call has cleared during a Route Optimisation sequence) are detailed in the text.
- 1.7** Coding of the contents of messages is given in SECTION 4.

2 ROUTE OPTIMISATION WITHIN DPNSS 1

2.1 DEFINITION

For various reasons, an established call through a DPNSS 1 network may not follow the optimum route between the two End PBXs. The Route Optimisation Supplementary Service offers the facility of obtaining a new connection between the two End PBXs using the preferred route.

On data calls, the use of this service may result in data loss, or corruption, at the point in time when optimisation takes place. Some PBXs may, therefore, reject requests to optimise data calls, or restrict optimisation to calls where it is known that sufficient error detection and recovery procedures exist to overcome the consequent disruption of the data.

2.2 DESCRIPTION

An established call through a DPNSS 1 network may follow a non-optimum route for reasons which include the following:

- The call was established by means of Transfer (Three-Party Supplementary Service);
- The call was established as a result of a Conference reducing to two parties (Three-Party Supplementary Service);
- An alternative route was used when the call was established owing to congestion on the optimum route;
- Unspecified action at another PBX, which results in a non-optimum route, which is indicated by receipt of an invitation to invoke Route Optimisation (Service Independent String: Route Optimisation Invite).

Whenever there is a possibility that a call follows a non-optimum route (eg after Transfer), the Originating PBX may initiate Route Optimisation. An attempt is made to obtain a new path from the Terminating PBX to the Originating PBX using the optimum route. Some or all of the existing path may be used if it already follows the optimum route and the PBXs concerned support Single-Channel Working. When a new path has been obtained, the unwanted parts of the original path are released. The whole of the existing path is retained if it already follows the optimum route or if the optimum route is congested. In the latter case, the Originating PBX may periodically try again.

2.3 OUTLINE OF OPERATION

The service is implemented using the following separate signal sequences:

- 2.3.1 Route Optimisation Service - Retention of None of the Existing Path.
- 2.3.2 Route Optimisation Service - Retention of Part of the Existing Path.
- 2.3.3 Route Optimisation Service - Retention of All of the Existing Path.
- 2.3.4 Route Optimisation Service - Acknowledged Invitation to invoke Route Optimisation.

2.3.1 ROUTE OPTIMISATION – RETENTION OF NONE OF THE EXISTING PATH

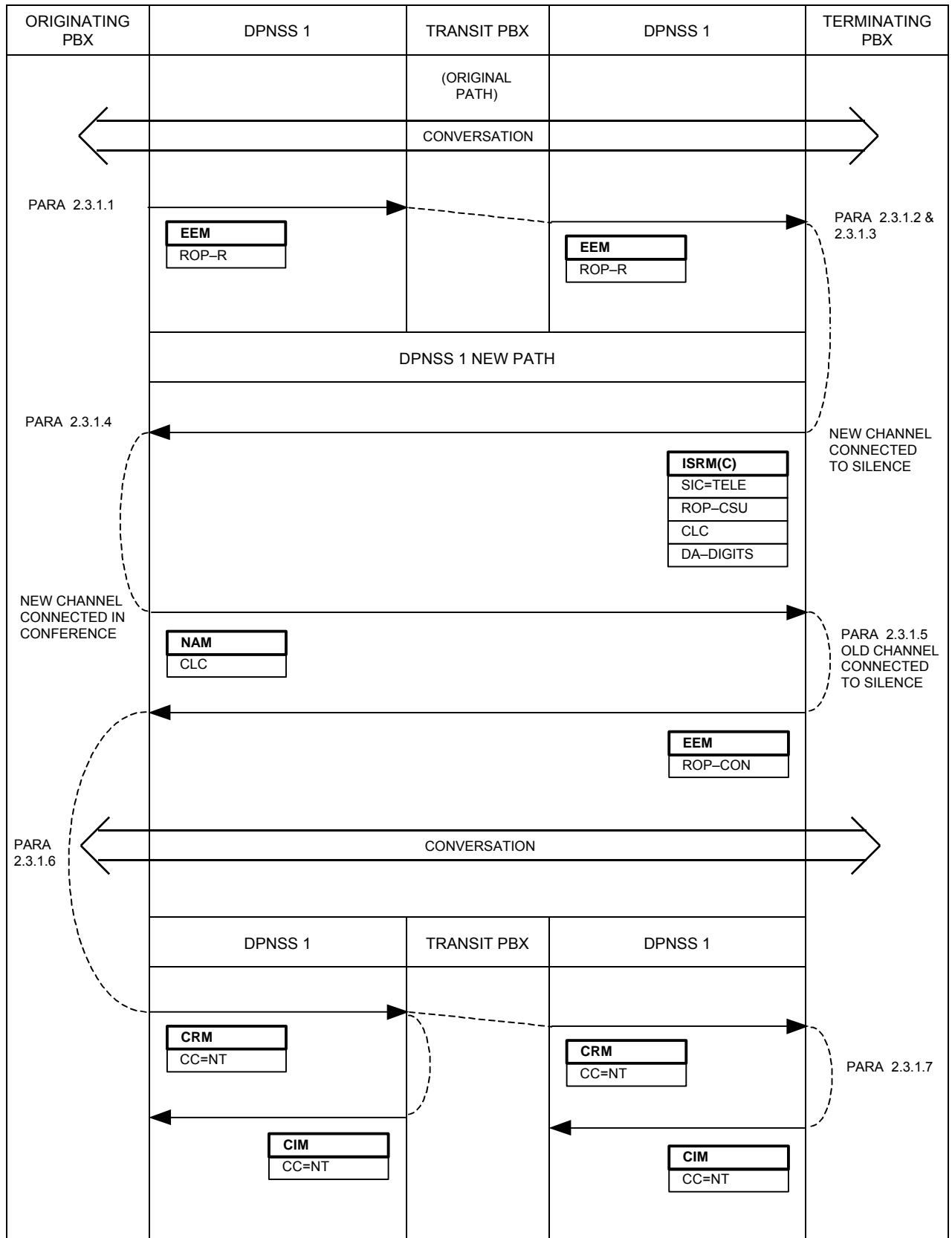

2.3.1.1 When a call has been transferred or for some other reason follows a non-optimum route through the DPNSS 1 network, its Originating PBX may initiate Route Optimisation. In the case of a call which is known to have been established on an alternative route because of congestion on the optimum route, Route Optimisation may be initiated after a suitable delay in anticipation of a path being available on the optimum route.

Route Optimisation shall not be initiated before Answer. If signalling on behalf of another Supplementary Service is taking place, Route Optimisation should be delayed until its completion.

An EEM containing a Route Optimisation-Request (ROP-R) is sent to the Terminating PBX. The Parameter of ROP-R is a string of digits which will be used as the Destination Address of the rerouted call from the Terminating PBX. It must contain the network address of the Originating PBX followed by further digits to identify the call uniquely.

As an option, the length of the part of the parameter that identifies the call may be encoded as a second parameter. Although not necessary in a pure DPNSS 1 environment, this indication may be necessary when interworking with other signalling systems which have an equivalent supplementary service where the address of the Originating PBX and the digits identifying the call are conveyed separately.

Until Route Optimisation is complete or has been rejected, the Originating PBX must not initiate signalling on behalf of any other Supplementary Service.

2.3.1.2 On receipt of an EEM containing ROP-R, the Terminating PBX attempts to establish a new call to the Originating PBX using the address given.

Until Route Optimisation is complete or has been rejected, the Terminating PBX must not initiate signalling on behalf of any other Supplementary Service.

If the Terminating PBX is not able to perform Route Optimisation, it shall return an EEM containing REJ.

2.3.1.3 If the Destination Address specified by the String ROP-R indicates that the Originating PBX is not the Terminating PBX, the Terminating PBX selects a new channel on the optimum outgoing route towards the Originating PBX. An ISRM(C), containing Route Optimisation-Call Set Up (ROP-CSU), the Destination Address and the CLC of the Terminating party, is sent along the new signalling channel. OLI is not required. The new traffic channel is connected to silence.

As an option, if the length of the part of the destination address that identifies the call was received as a parameter

to ROP-R, this may be relayed back towards the Originating PBX by encoding it as a parameter to ROP-CSU. Although not necessary in a pure DPNSS 1 environment, this indication may be necessary when interworking with other signalling systems which have an equivalent supplementary service where the address of the Originating PBX and the digits identifying the call are conveyed separately.

If there is no channel available, the Terminating PBX returns an EEM containing REJ to the Originating PBX.

If the Destination Address specified by the String ROP-R indicates that the Originating PBX is also the Terminating PBX, the PBX shall replace the DPNSS 1 connections by an internal connection between the two end parties and clear the DPNSS 1 channels by means of CRMs containing Clearing Cause: Network Termination (NT).

2.3.1.4 Transit PBXs (not shown in MSD) handle an ISRM(C) containing ROP-CSU as for the Simple Call, except that the call will be rejected with the Clearing Cause : Congestion (CON) if there is no channel available on the first-choice route.

When the ISRM(C) containing ROP-CSU arrives at the PBX indicated by the Destination Address (DA), the PBX checks that it has initiated Route Optimisation on behalf of the call identified by the DA. If so, a NAM containing the CLC of the Originating Party is returned along the new signalling channel and the new traffic channel is connected in conference with the existing call.

If the DA does not identify a call on which route Optimisation has been initiated, the new call is cleared by sending a CRM containing the Clearing Cause: Facility Not Registered (FNR). This could occur if the original call has cleared.

If an EEM containing REJ is received from the original channel, the Originating PBX abandons the attempt at Route Optimisation but may try again later. The interval between attempts shall be not less than 60 s.

2.3.1.5 On receipt of a NAM from the new channel, the Terminating PBX connects the new traffic channel in place of the old traffic channel and connects the old traffic channel to silence. An EEM containing Route Optimisation-Connected (ROP-CON) is sent along the new signalling channel. The call then continues as normal using the new path. The original channel is left to clear.

As an option, ROP-CON may also be sent in an EEM on the old path. Although not necessary in a pure DPNSS 1 environment, this indication may be necessary when interworking with other signalling systems which have an equivalent supplementary service where clearing of the old path is initiated by the Terminating PBX, as opposed to the Originating PBX.

On receipt of a CRM from the new channel, the Terminating PBX responds with a CIM and sends an EEM containing REJ along the original channel.

If a NIM indicating Alternative Routing is received from the new signalling channel (from a PBX not supporting this service), the Terminating PBX clears the new call by sending a CRM containing the Clearing Cause: Network Termination (NT) and expects a CIM in response. An EEM containing REJ is sent along the original signalling channel.

If the original call terminates before receipt of a NAM or CRM from the new channel, the Terminating PBX sends a CRM containing the Clearing Cause: Call Termination (CT) along the new signalling channel and expects a CIM in response. This is in addition to normal call termination procedures.

2.3.1.6 On receipt of an EEM containing ROP-CON from the new signalling channel, the Originating PBX disconnects the original traffic channel from the call, leaving the new traffic channel connected. The old path is cleared by sending a CRM containing the Clearing Cause: NT.

If a CRM is received from the new signalling channel, the Originating PBX responds with a CIM and disconnects the new traffic channel from the call. An EEM containing REJ can be expected from the original signalling channel.

If the call terminates before receipt of the EEM ROP-CON, a CRM containing the Clearing Cause: CT is sent along the new channel and a CIM is expected in response. This is in addition to normal call termination procedures.

2.3.1.7 On receipt of a CRM from the old signalling channel, the channel is freed.

2.3.2 ROUTE OPTIMISATION - RETENTION OF PART OF THE EXISTING PATH

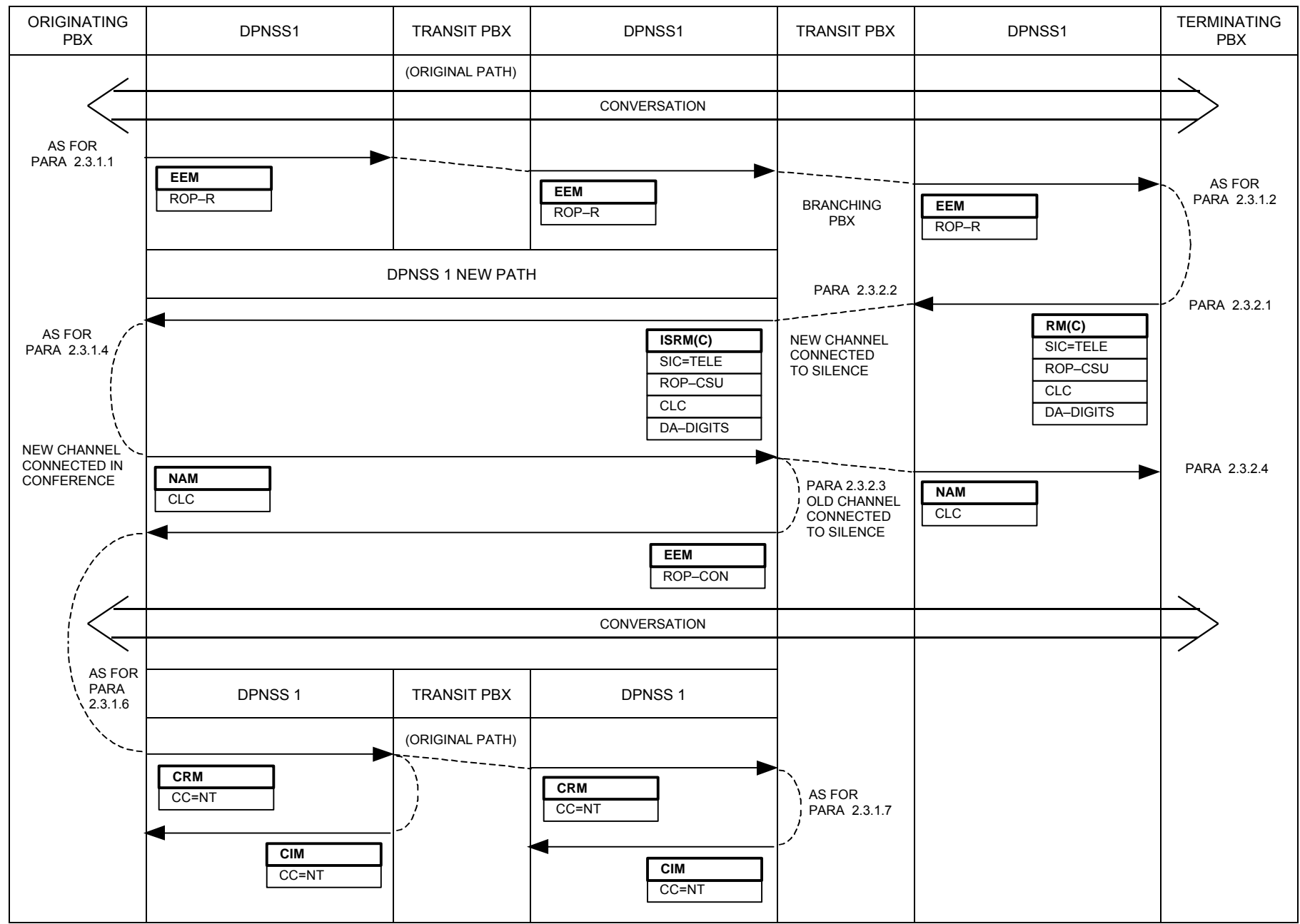

2.3.2.1 If the existing channel lies on the best available route out of the Terminating PBX towards the Originating PBX and Single-Channel Working is supported, an RM(C) containing ROP-CSU, the Destination Address and the CLC of the Terminating party is sent.

2.3.2.2 On receipt of an RM(C) containing ROP-CSU, a Transit PBX will route according to the Destination Address. This sequence shows the case where the existing path does not follow the optimum route. A new outgoing channel is selected on the optimum route and an ISRM(C) containing ROP-CSU, the Destination Address and the CLC of the Terminating party is sent. The new traffic channel is connected to silence. The Transit PBX becomes the Branching PBX.

If there is no channel available, the Transit PBX returns an RRM containing the Rejection Cause: CON.

2.3.2.3 On receipt of a NAM containing the CLC of the Originating party from the new channel, the Branching PBX disconnects the original traffic channel and connects the new traffic channel in its place. Silence is connected to the original traffic channel. An EEM containing ROP-CON is sent back along the new signalling channel and the NAM is passed on towards the Terminating PBX. The Branching PBX becomes a simple Transit PBX again and the call continues normally using the new path. The original channel is left to clear.

On receipt of a CRM from the new channel, the Branching PBX responds with a CIM. It also sends an RRM with the same Rejection Cause towards the Terminating PBX.

If a NIM indicating Alternative Routing is received from the new signalling channel, the Branching PBX clears the new call by sending a CRM containing the Clearing Cause: NT and expects a CIM in response. An RRM with Clearing Cause: CON is sent towards the Terminating PBX.

If the original call terminates before receipt of a NAM or CRM from the new channel, a CRM containing the Clearing Cause: CT is sent along the new channel and a CIM is expected in response. This is in addition to normal call termination procedures.

2.3.2.4 Receipt of a NAM indicates to the Terminating PBX that Route Optimisation is complete.

On receipt of an RRM, the Terminating PBX sends an EEM containing REJ to the Originating PBX via the original path. Alternatively, if the Rejection Cause is SNU and String RR-SNU is present, the Terminating PBX may try again using a separate channel.

2.3.3 ROUTE OPTIMISATION – RETENTION OF ALL OF THE EXISTING PATH

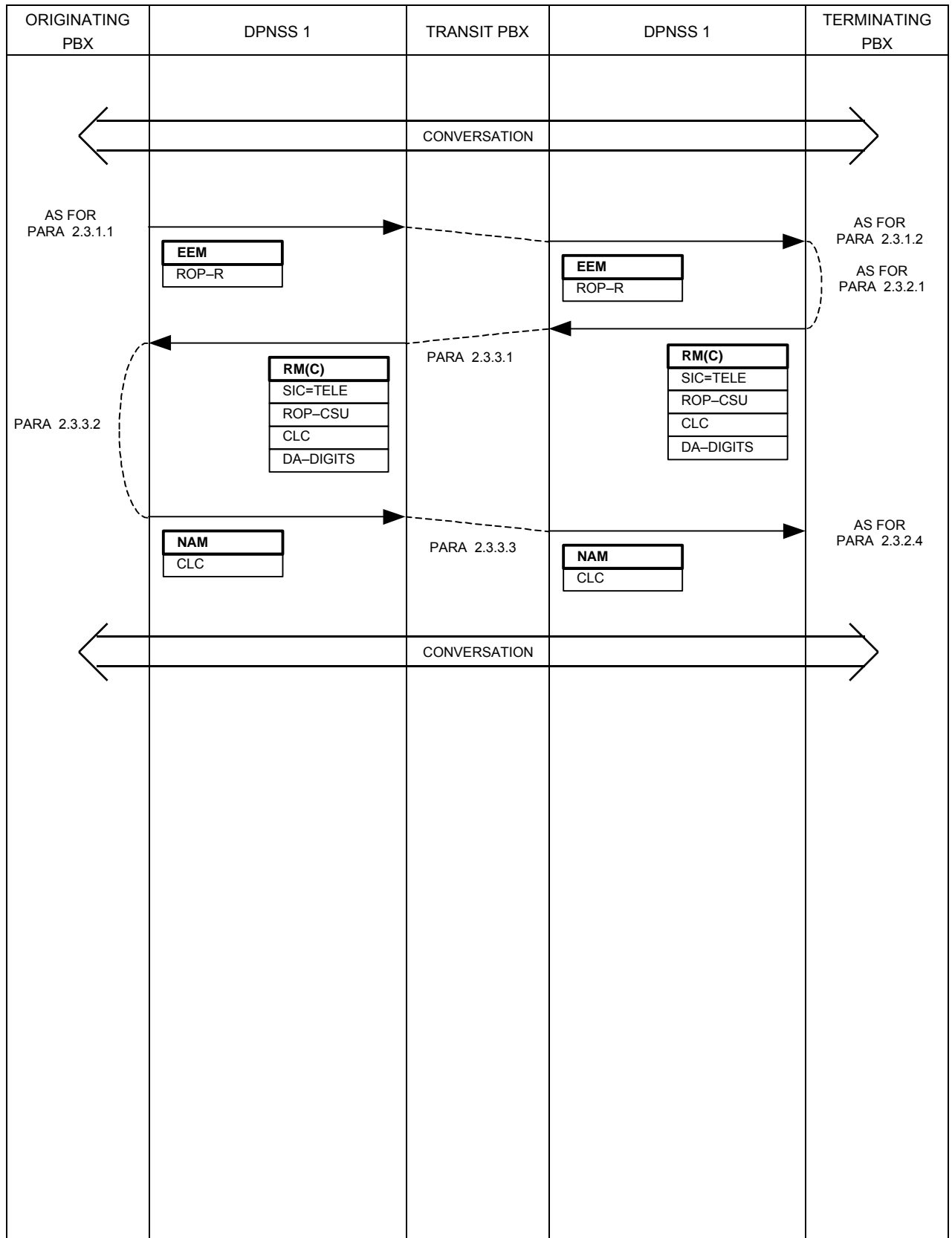

2.3.3.1 On receipt of an RM(C) containing ROP-CSU, a Transit PBX passes it on if the existing channel lies on the optimum route towards the Originating PBX.

2.3.3.2 On receipt of an RM(C) containing ROP-CSU, the Originating PBX responds with a NAM and the call continues to use the existing path.

2.3.3.3 Transit PBXs pass on any NAM or RRM. However, in the case of an RRM containing the Rejection Cause: SNU and String RR-SNU, a Transit PBX may try again using a separate channel.

2.3.4 Route Optimisation - Acknowledged Invitation to invoke Route Optimisation

In addition to the unacknowledged invitation to invoke Route Optimisation described in Paragraph 3.30 of SECTION 16, a PBX may request that the Route Optimisation sequence be initiated by sending an EEM containing ROP-INVA, after completion of the routing phase of the call, to the PBX which is required to act as the Originating PBX.

On receipt of ROP-INVA, the receiving PBX may invoke Route Optimisation as described in Paragraph 2.3.1.1 once the call has reached an appropriate state. If optimisation will not be attempted, an EEM containing REJ shall be returned in response. If optimisation will be attempted, but the attempt needs to be delayed until the call reaches a suitable state, an EEM containing ACK shall be returned in response. If optimisation will be attempted immediately, responding with an EEM containing ACK is optional; if not sent the consequent EEM containing ROP-R shall be interpreted as a positive acknowledgement by the PBX sending ROP-INVA.

If an EEM containing REJ or IG-SNU is received in response to sending ROP-INVA, then it is the responsibility of the sending PBX to attempt Route Optimisation, by acting as the Originating PBX, once the call has reached an appropriate state.

3 COMPLIANCE SHEETS FOR SUPPLEMENTARY SERVICE: ROUTE OPTIMISATION

The Route Optimisation Supplementary Service is an optional part of DPNSS 1 and its provision on a PBX is a matter for negotiation between a customer and his supplier (see FOREWORD in SECTION 0 of this specification). This Subsection may be used as an aid to those negotiations.

NOTE: Whilst the provision of this service is optional, if it is provided, compliance with certain features of the service becomes mandatory.

Compliance with the service is considered in terms of the function(s) to be performed by the PBX, ie Transit, End or Branching, and the extent to which extensions or operators on the PBX can request the service.

The options available are given in TABLE 1. This table should be completed by a manufacturer to indicate PBX capability and by a purchaser to indicate PBX requirements.

TABLES 2 to 4 indicate the features that are required/provided at each PBX. The pre-printed "YES" indicates that the feature is a mandatory part of the service for that PBX function.

TABLE 1

PBX FUNCTION		APPLICABLE TABLE
PBX that has extensions and can initiate the service		TABLES 2 & 3
PBX that has extensions but cannot initiate the service		TABLE 2
Transit PBX		TABLE 4

TABLE 2

COMPLIANCE TABLE FOR A PBX WITH EXTENSIONS IN A NETWORK THAT SUPPORTS ROUTE OPTIMISATION			
SERVICE VARIANT			COMMENT
Able to establish a Route Optimisation Call Set Up on receipt of a Route Optimisation Request?	via a separate channel	YES	
	via the same channel as the existing call		
Able to support indication of Call Identity Length?			
Able to send optimisation complete indication (ROP-CON) on the old path?			

TABLE 3

ADDITIONAL COMPLIANCE TABLE FOR A PBX WHICH HAS EXTENSIONS AND IS ABLE TO INITIATE ROUTE OPTIMISATION			
SERVICE VARIANT			COMMENT
Able to send Route Optimisation - Request?		YES	Mandatory
Able to accept and respond correctly to a Route Optimisation Call Set-Up?	via a separate channel	YES	PBX has conference capabilities
	via the same channel as the existing call		
Able to support indication of call identity length?			
Able to send Route Optimisation Invite with Acknowledgement request?			
Able to act on receipt of Route Optimisation Invite with Acknowledgement request?			

TABLE 4

COMPLIANCE TABLE FOR A TRANSIT PBX IN A NETWORK THAT SUPPORTS ROUTE OPTIMISATION		
SERVICE VARIANT		COMMENT
Able to transit Route Optimisation Requests?	YES	Inherent DPNSS 1 Capability
Able to prevent Alternative Routing during Route Optimisation Call Set-Up received on a separate channel?	YES	
Able to transit Route Optimisation Call Set-Up received on the same channel as the existing call?	Non-Branching	
	Branching	
Able to transit Route Optimisation Invite with Acknowledgement requests?		Inherent DPNSS 1 Capability

DIGITAL PRIVATE NETWORK SIGNALLING SYSTEM NO 1 (DPNSS 1)

SECTION 20 - SUPPLEMENTARY SERVICE: EXTENSION-STATUS CALL

CONTENTS

1	GENERAL	Page 2
2	EXTENSION-STATUS CALL WITHIN DPNSS 1	Page 3
	2.1 DEFINITION.....	Page 3
	2.2 DESCRIPTION.....	Page 3
	2.3 OUTLINE OF OPERATION.....	Page 3
	2.3.1 Extension-Status Call.....	Page 4
3	COMPLIANCE	Page 6

HISTORY

Issue 1 - September 1984
Issue 2 - March 1986
Issue 3 - December 1989

Issue 4 - March 2001 - Specification renamed as DPNSS[188]

1 GENERAL

1.1 This Section details the signalling requirements of DPNSS 1 for the Extension-Status Call Supplementary Service.

1.2 Subsection 2 details the service within DPNSS 1.

1.3 Subsection 3 shows the Compliance.

1.4 The description is given in the form of Message Sequence Diagrams (MSDs) followed by explanatory text.

1.5 The text is referenced from MSDs at appropriate points in the sequences.

1.6 Message contents for an Extension-Status Call to a free extension (without Diversion Supplementary Service active) are shown in the MSD. Messages and their contents for alternative Extension-Status Calls are detailed in the text.

1.7 Coding of the contents of messages is given in SECTION 4.

2 EXTENSION-STATUS CALL WITHIN DPNSS 1

2.1 DEFINITION

The Extension-Status Call Supplementary Service offers the capability of determining, on request, the status of an extension.

2.2 DESCRIPTION

This service permits the establishment of a Virtual Call to an extension in order to determine its state (free, busy, out of service, diverted, etc) without calling the extension.

It might be used by an operator, before the establishment of a call on behalf of an extension, in order to improve the chances of the extension being free when the call is ready. It might also be used to investigate complaints.

2.3 OUTLINE OF OPERATION

This facility is implemented using the following signal sequence:

2.3.1 EXTENSION – STATUS CALL

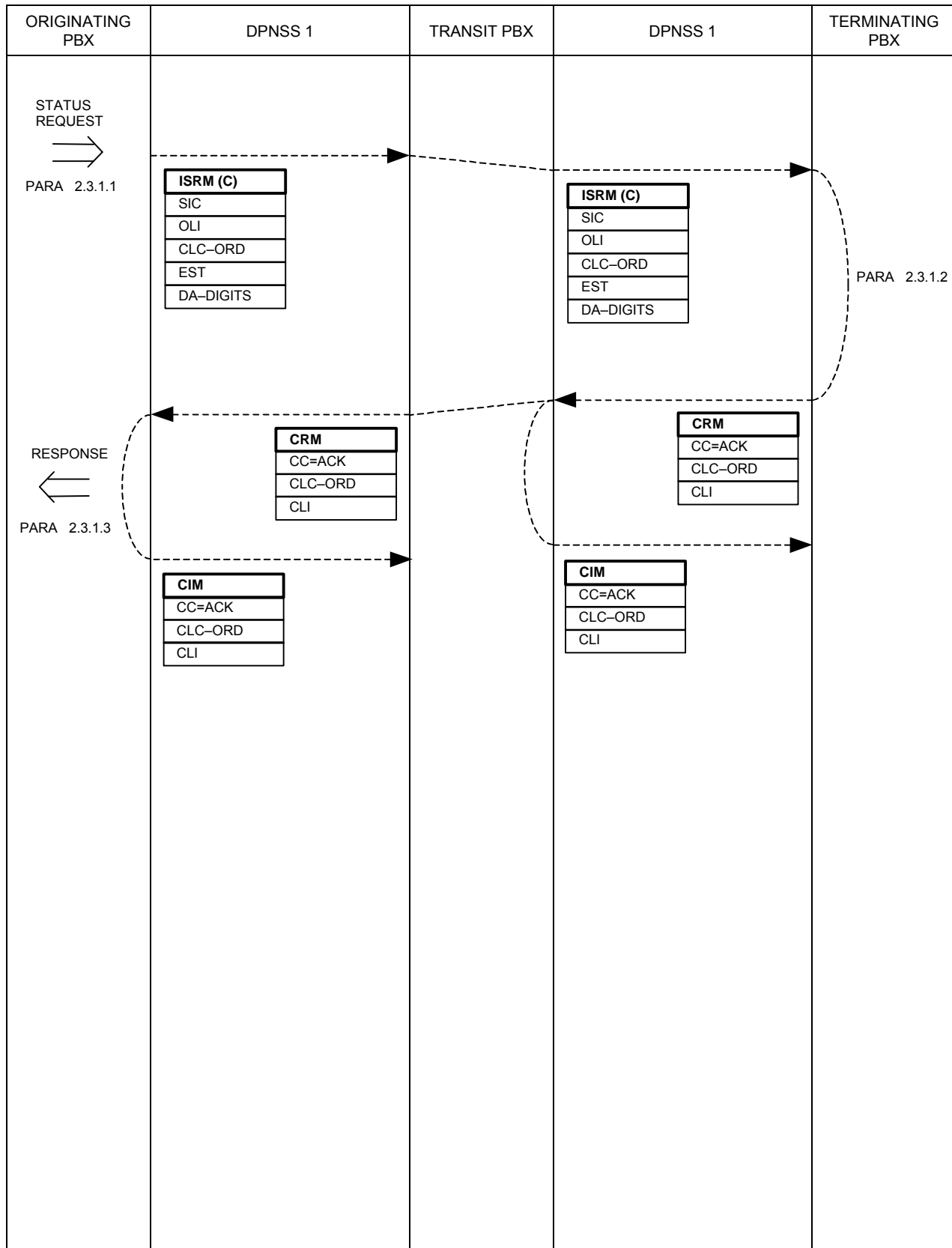

2.3.1.1 A user with the necessary Class of Service may request the status of another extension. The Originating PBX selects a free Virtual Channel and sends an ISRM containing the SIC, CLC, OLI, Extension-Status Call (EST) and the Destination Address.

2.3.1.2 The response to an ISRM containing EST is always a CRM. Any of the Clearing Causes applicable to a Simple Call also apply to an Extension-Status Call. In addition, the following possibilities exist:

- i. If the called extension is free, the Clearing Cause: Acknowledgement (ACK) is used and the Called Line Category and the Called Line Identity are included.
- ii. If the called extension is busy but is capable of invoking the Call Waiting Service, the Clearing Cause: Busy (BY) is used and String Call Waiting (CW) is included.
- iii. If the called extension has Diversion Immediate active, String DVT-I is included. The Clearing Cause reflects the status of the originally called extension, eg ACK, BY.
- iv. If the called extension is not free and has Diversion on Busy active, String DVT-B is included. The Clearing Cause reflects the status of the original called extension, eg Busy (BY), Subscriber Out of Service (SOS).
- v. If the called extension is free and has Diversion on No Reply active, String DVT-R is included in the CRM containing the Clearing Cause:(ACK).

2.3.1.3 On receipt of a CRM containing one of the Clearing Causes listed in paragraph 2.3.1.2, the called-extension status is indicated to the calling party.

Receipt of a CRM containing any other Clearing Cause indicates that the Extension Status Call has failed and no information is known about the called extension. An appropriate indication shall be given to the requesting party.

3 COMPLIANCE SHEETS FOR SUPPLEMENTARY SERVICE: EXTENSION-STATUS CALL

The Extension-Status Call Supplementary Service is an optional part of DPNSS 1 and its provision on a PBX is a matter for negotiation between a customer and his supplier (see FOREWORD in SECTION 0 of this specification). This Subsection may be used as an aid to those negotiations.

NOTE: Whilst the provision of this service is optional, if it is provided, compliance with certain features of the service becomes mandatory.

Compliance with the service is considered in terms of the function(s) to be performed by the PBX, ie Transit, End or Branching, and the extent to which extensions or an operator on the PBX can request the service.

The options available are given in TABLE 1. This table should be completed by a manufacturer to indicate PBX capability and by a purchaser to indicate PBX requirements.

TABLES 2 to 4 indicate the features that are required/provided at each PBX. The pre-printed "YES" indicates that the feature is a mandatory part of the service for that PBX function.

TABLE 1

PBX FUNCTION		APPLICABLE TABLE
PBX with an operator or extensions, some of which can request the service		TABLES 2 and 3
PBX with operators or extensions, none of which can request the service		TABLE 2
Transit PBX		TABLE 4

TABLE 2

COMPLIANCE TABLE FOR A PBX WITH OPERATORS OR EXTENSIONS IN A NETWORK THAT SUPPORTS EXTENSION-STATUS CALL		
SERVICE VARIANT		COMMENT
Able to respond correctly to an Extension-Status Call?	YES	

TABLE 3

ADDITIONAL COMPLIANCE TABLE FOR A PBX WITH OPERATORS OR EXTENSIONS THAT ARE ABLE TO REQUEST AN EXTENSION-STATUS CALL		
SERVICE VARIANT		COMMENT
Able to originate an Extension-Status Call?	YES	

TABLE 4

COMPLIANCE TABLE FOR A TRANSIT PBX IN A NETWORK THAT SUPPORTS EXTENSION-STATUS CALL		
SERVICE VARIANT		COMMENT
Able to transit an Extension-Status Call?	YES	Inherent DPNSS 1 capability

DIGITAL PRIVATE NETWORK SIGNALLING SYSTEM NO 1 (DPNSS 1)

SECTION 21 - SUPPLEMENTARY SERVICE: CONTROLLED DIVERSION

CONTENTS

1	GENERAL	Page 2
2	CONTROLLED DIVERSION WITHIN DPNSS 1	Page 3
2.1	DEFINITION.....	Page 3
2.2	DESCRIPTION.....	Page 3
2.3	OUTLINE OF OPERATION.....	Page 4
2.3.1	Controlled Diversion - Immediate.....	Page 5
2.3.2	Controlled Diversion - On Busy.....	Page 7
2.3.3	Controlled Diversion - On No Reply.....	Page 9
3	COMPLIANCE	Page 11

HISTORY

Issue 1 - September 1984
Issue 2 - March 1986
Issue 3 - December 1989

Issue 4 - March 2001 - Specification renamed as DPNSS[188]

1 GENERAL

1.1 This Section details the signalling requirements of DPNSS 1 for the Controlled Diversion Supplementary Service.

1.2 Subsection 2 details the service within DPNSS 1.

1.3 Subsection 3 shows the Compliance.

1.4 The description is given in the form of Message Sequence Diagrams (MSDs) followed by explanatory text.

1.5 The text is referenced from MSDs at appropriate points in the sequence.

1.6 Message contents for successful calls are shown in MSDs. Messages and their contents for alternative sequences are detailed in the text.

1.7 Coding of the contents of messages is given in SECTION 4.

2 CONTROLLED DIVERSION WITHIN DPNSS 1

2.1 DEFINITION

The Controlled Diversion Supplementary Service offers callers who encounter Call Diversion (see SECTION 11) the capability of either allowing the diversion to proceed or of exercising alternative control over the subsequent progress of the call.

2.2 DESCRIPTION

The Controlled Diversion Supplementary Service, in conjunction with the Diversion Supplementary Service (SECTION 11), permits a party originating a call to request to be informed if Diversion (Immediate, On Busy or On No Reply) is encountered. The calling party, having been informed of a diversion, can decide whether to proceed with the diversion or take alternative action. The options available depend on the type of diversion:

Immediate

Proceed with the diversion;

Clear the call;

By-pass the diversion if the called extension is free, or invoke another Supplementary Service for completing the call if the extension is busy, eg Call Back When Free, Call Offer or Intrusion;

On Busy

Proceed with the diversion;

Clear the call;

Invoke another Supplementary Service for completing the call to the busy extension, eg Call Back When Free, Call Offer, Intrusion;

On No Reply

Proceed with the diversion;

Clear the call;

Continue to ring the originally called extension.

The calling party is informed of Diversion On No Reply as soon as the called extension is rung. This allows the calling party to decide how long to ring the extension before allowing the diversion to proceed.

2.3 OUTLINE OF OPERATION

This facility is implemented using the following separate signal sequences:

- 2.3.1 Controlled Diversion - Immediate,
- 2.3.2 Controlled Diversion - On Busy,
- 2.3.3 Controlled Diversion - On No Reply.

2.3.1 CONTROLLED DIVERSION - IMMEDIATE

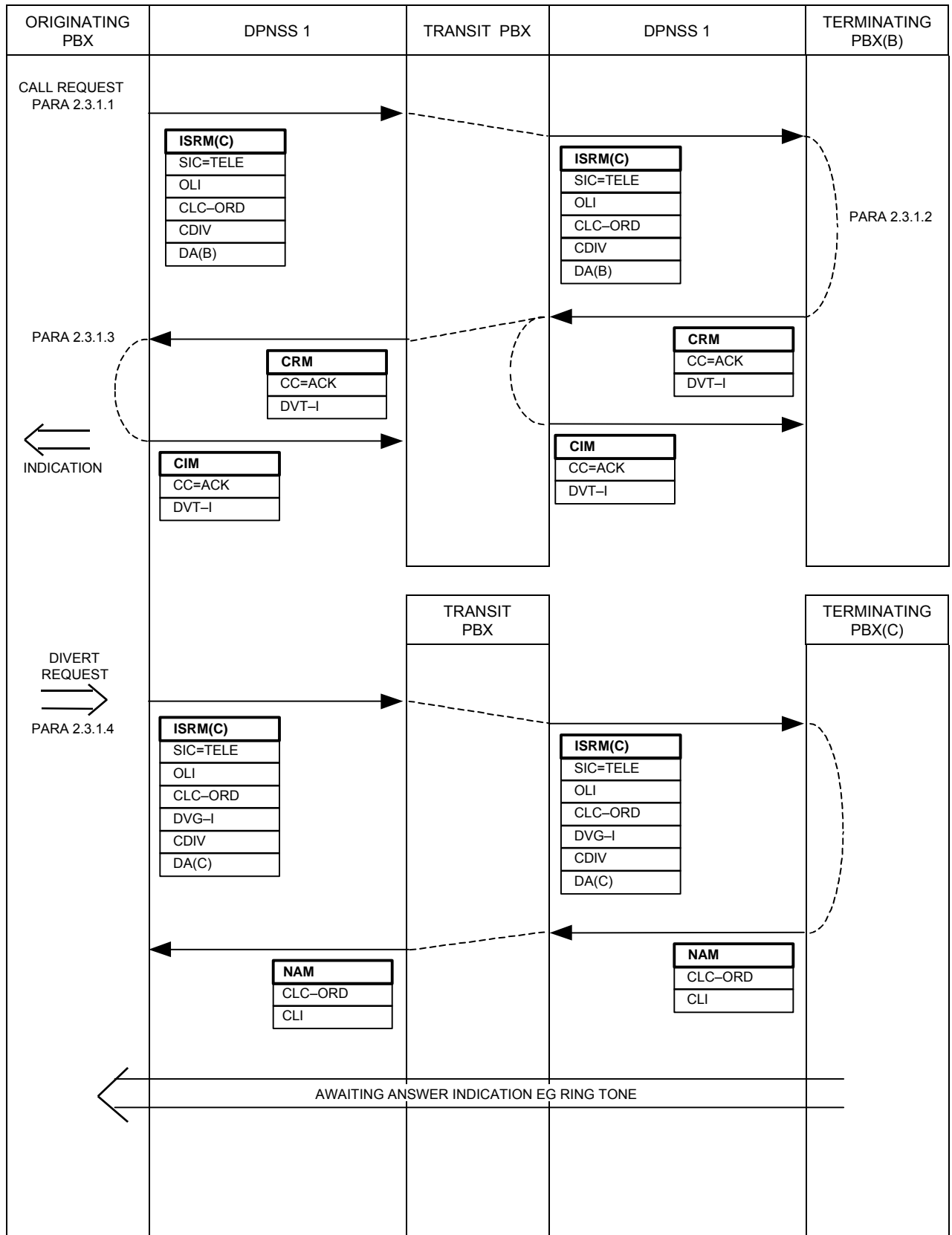

2.3.1.1 Certain types of extension may permit the user to have control over the action to be taken when diversion is encountered. When the extension user originates a call, the String Controlled Diversion (CDIV) shall be included in the ISRM.

2.3.1.2 On receipt of an ISRM containing CDIV, the Terminating PBX shall process it as for a Simple Call unless Diversion is encountered. In this case Diversion Immediate has been encountered. If the wanted extension is free, the call shall be cleared by sending a CRM containing the Clearing Cause: Acknowledgement (ACK) together with String Divert Immediate (DVT-I) (the Parameter of which is the address to divert to). A CIM is expected in response. No distinction is made between on-PBX and off-PBX diversion.

If the wanted extension is not free (eg the extension is busy or out of service) the call shall be cleared with a CRM containing an appropriate Clearing Cause (see SECTION 4, ANNEX 3) instead of ACK. The String DVT-I shall be included as before.

2.3.1.3 On receipt of a CRM containing String DVT-I, the Originating PBX shall indicate to the user that Diversion Immediate has been encountered. The state of the extension, as denoted by the Clearing Cause, may also be indicated to the user.

2.3.1.4 If the user requests that diversion should go ahead, a new call shall be established; the address given in the Parameter to String DVT-I shall be used as the Destination Address and String Diverting Immediate (DVG-I) shall be included in the ISRM. String CDIV shall be included again in case a further diversion is encountered.

Alternatively, the user may request to by-pass the diversion, in which case another call shall be made to the original destination, this time with String Diversion Bypass (DIV-BY) instead of CDIV in the ISRM. If the called extension is busy, the user may request another Supplementary Service in an attempt to complete the call to that destination.

2.3.2 CONTROLLED DIVERSION – ON BUSY

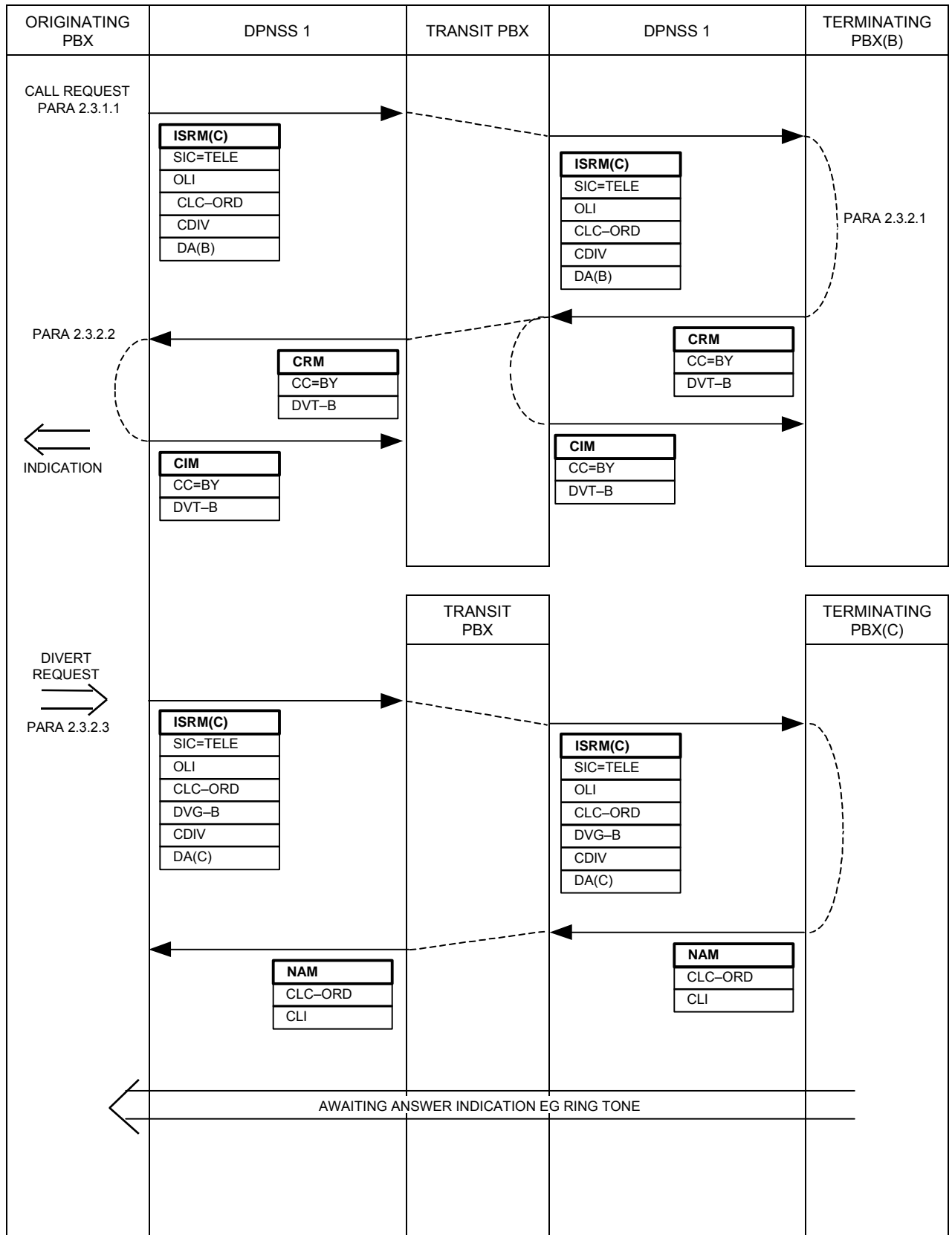

2.3.2.1 On receipt of an ISRM containing CDIV, the Terminating PBX treats it as for a Simple Call unless diversion is encountered. In this case the extension is busy and Diversion On Busy is registered. The call is cleared by sending a CRM containing the Clearing Cause: BY together with String Divert on Busy (DVT-B) (the Parameter of which is the address to divert to). A CIM is expected in response. No distinction is made between on-PBX and off-PBX diversion.

If the called extension is out of service, the Clearing Cause: SOS is used instead of BY.

2.3.2.2 On receipt of a CRM containing the Clearing Cause: BY and the String DVT-B, the Originating PBX indicates to the user that Diversion On Busy has been encountered.

If a CRM is received with any other Clearing Cause, the call fails and continues as for a failed Simple Call.

2.3.2.3 If the user requests that diversion should go ahead, a new call is established: the address given in String DVT-B is used as the Destination Address, and String DVG-B is included in the ISRM. String CDIV is included again in case a further diversion is encountered.

Alternatively, if the Clearing Cause was BY, the user may request another Supplementary Service in an attempt to complete the call to the original destination.

2.3.3 CONTROLLED DIVERSION – ON NO REPLY

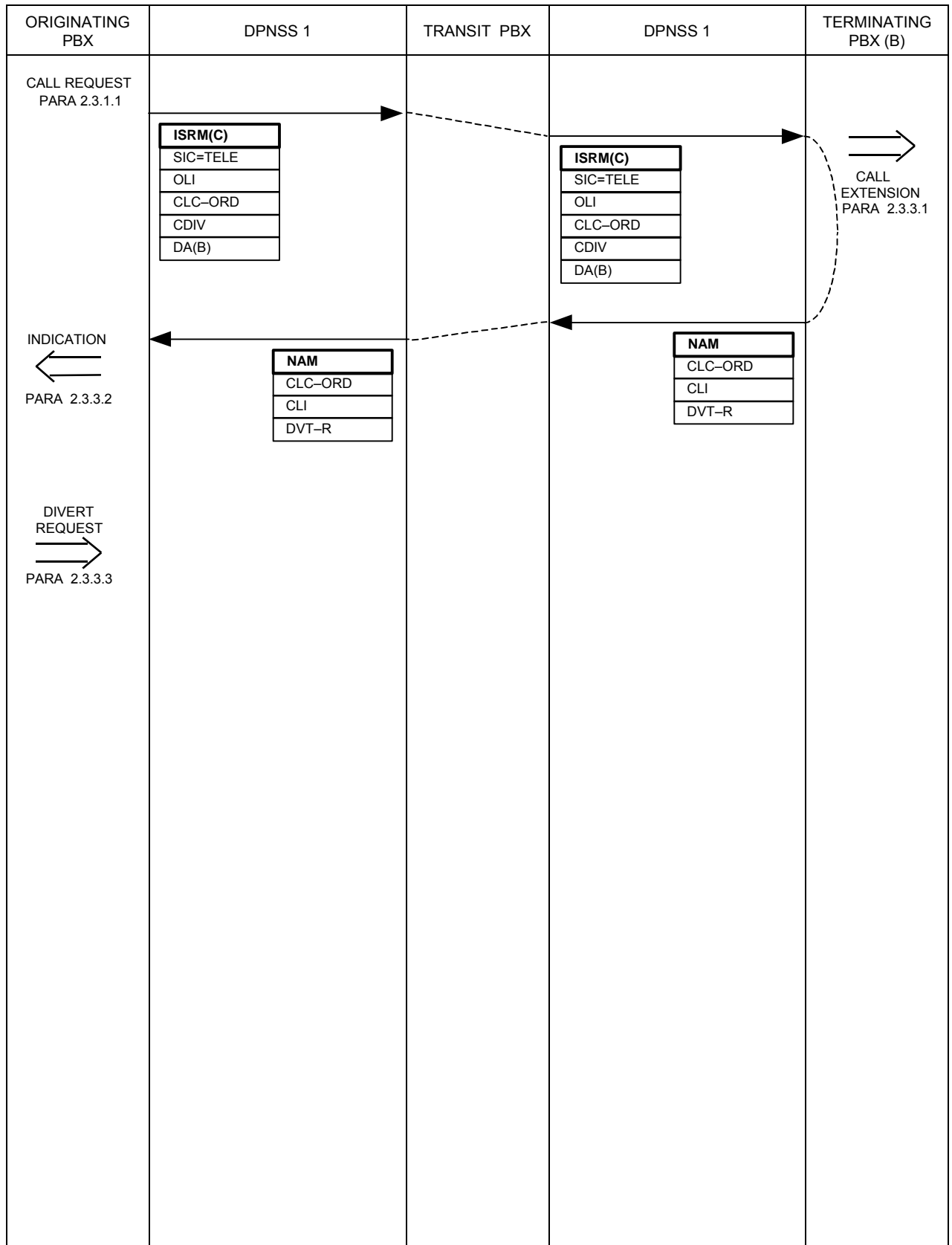

2.3.3.1 On receipt of an ISRM containing CDIV, the Terminating PBX treats it as for a Simple Call unless Diversion is encountered. In this case the extension is free and Diversion On No Reply is registered. The extension is called and a NAM is returned as normal. Included in the NAM is String Divert On No Reply (DVT-R) to indicate that Diversion On No Reply has been encountered. The Parameter of String DVT-R is the address to divert to. No distinction is made between on-PBX and off-PBX diversion.

The Terminating PBX does not run a timeout for no reply.

2.3.3.2 The Originating PBX treats the NAM as normal but indicates to the calling party the fact that Diversion On No Reply has been requested.

2.3.3.3 The calling party can decide whether and when to divert. On receipt of a request to divert, the Originating PBX establishes a new call either via a different channel or via the same channel using the signalling procedures in SECTION 11, paragraphs 2.3.9 and 2.3.10, respectively. String Diverting On No Reply (DVG-R) is included in the ISRM for the new call as is String CDIV in case further diversion is encountered.

3 COMPLIANCE SHEETS FOR SUPPLEMENTARY SERVICE: CONTROLLED DIVERSION

The Controlled Diversion Supplementary Service is an optional part of DPNSS 1 and its provision on a PBX is a matter for negotiation between a customer and his supplier (see FOREWORD in SECTION 0 of this specification). This Subsection may be used as an aid to those negotiations.

NOTE: Whilst the provision of this service is optional, if it is provided, compliance with certain features of the service becomes mandatory.

Compliance with the service is considered in terms of the function(s) to be performed by the PBX, ie Transit, End or Branching, and the extent to which an operator or extensions on the PBX can request the service.

The options available are given in TABLE 1. This table should be completed by a manufacturer to indicate PBX capability and by a purchaser to indicate PBX requirements.

TABLES 2 to 4 indicate the features that are required/provided at each PBX. The pre-printed "YES" indicates that the feature is a mandatory part of the service for that PBX function.

TABLE 1

PBX FUNCTION		APPLICABLE TABLE
PBX with operators or extensions, some of which can request the service		TABLES 2 & 3
PBX with operators or extensions, none of which can request the service		TABLE 2
Transit PBX		TABLE 4

TABLE 2

COMPLIANCE TABLE FOR A PBX WITH OPERATOR OR EXTENSIONS IN A NETWORK THAT SUPPORTS THE CONTROLLED DIVERSION SERVICE		
SERVICE VARIANT		COMMENT
Able to respond correctly to an incoming Controlled Diversion call for an extension that has diversion registered on it?	YES	
Able to accept an incoming controlled diversion call for extensions that have not got diversion registered?	YES	Simple Call

TABLE 3

ADDITIONAL COMPLIANCE TABLE FOR PBXs WITH OPERATORS OR EXTENSIONS THAT ARE ABLE TO REQUEST CONTROL OF DIVERSION		
SERVICE VARIANT		COMMENT
Able to indicate on outgoing calls that control of any diversion that may be encountered is required?	YES	
Able to make a diverted call on receipt of an indication that the called extension has diversion registered and that the calling extension wishes the diversion to proceed?	YES	

TABLE 4

COMPLIANCE TABLE FOR A TRANSIT PBX IN A NETWORK THAT SUPPORTS THE SUPPLEMENTARY SERVICE CONTROLLED DIVERSION		
SERVICE VARIANT		COMMENT
Able to transit Controlled Diversion calls?	YES	Inherent DPNSS 1 Capability

DIGITAL PRIVATE NETWORK SIGNALLING SYSTEM NO 1 (DPNSS 1)

SECTION 22 - SUPPLEMENTARY SERVICE: REDIRECTION

CONTENTS

1	GENERAL	Page 2
2	REDIRECTION WITHIN DPNSS 1	Page 3
2.1	DEFINITION.....	Page 3
2.2	DESCRIPTION.....	Page 3
2.3	OUTLINE OF OPERATION.....	Page 4
2.3.1	Redirection by the Originating PBX via a Different Channel.....	Page 5
2.3.2	Redirection by the Originating PBX via the same Channel.....	Page 8
2.3.3	Redirection request by the Terminating PBX.....	Page 10
2.3.4	Redirection by the Originating PBX on Call Failure.....	Page 12
2.3.5	Redirection Requested by the Terminating PBX on Call Failure.....	Page 14
2.3.6	Redirection Bypass Request.....	Page 16
3	COMPLIANCE	Page 18

HISTORY

Issue 1 - September 1984
Issue 2 - March 1986
Issue 3 - December 1989
Issue 4 - January 1995

Issue 5 - March 2001 - Specification renamed as DPNSS[188]
- Clearing during DVG-R Call Set Up added

1 GENERAL

1.1 This Section details the signalling requirements of DPNSS 1 for the Redirection Supplementary Service.

1.2 Subsection 2 details the service within DPNSS 1.

1.3 Subsection 3 shows the Compliance.

1.4 The description is given in the form of Message Sequence Diagrams (MSDs) followed by explanatory text.

1.5 The text is referenced from MSDs at appropriate points in the sequences.

1.6 Message contents for successful calls are shown in the MSDs. Messages and their contents for alternative sequences (eg for calls in which Redirection is unsuccessful) are detailed in the text.

1.7 Coding of the contents of messages is given in SECTION 4.

2 REDIRECTION WITHIN DPNSS 1

2.1 DEFINITION

The Redirection Supplementary Service offers callers awaiting connection or reconnection the facility of being redirected to an alternative destination after a certain time. Additionally, a failed call may be redirected to an alternative destination immediately.

2.2 DESCRIPTION

The Redirection Supplementary Service permits a call which is awaiting connection or reconnection to an extension to be redirected to an alternative destination. Redirection is initiated by the waiting party's PBX if the call does not progress within a certain time.

As an option the Terminating PBX may request that redirection be initiated by the Originating PBX. A PBX acting as an Originating PBX, however, is not obliged to support this option and may consequently ignore such a request.

The decision to redirect and the address to redirect to may depend on the type of the waiting party. For example, a PBX might redirect PSTN lines but not extensions. Often the address to redirect to is an operator.

Redirection may apply while awaiting answer, while being held by an extension or while awaiting connection to a busy extension (following Call Offer, Wait on Busy or Call Waiting).

The decision to redirect and the address to redirect to may also depend on the history of the call. For example, if the call arrived in one of the above states as a result of transfer, it may be redirected back to the party who transferred; that party may be an operator.

Channel optimisation is possible on redirected calls. If all or part of the path used by the existing call is along the best available route for the redirected call, the redirected call may use that path (Single-Channel Working). This reduces the transmission-channel traffic and call-blocking probability.

In addition, the service permits an Originating PBX to redirect a failed call to an alternative destination. The decision to redirect and the address to redirect to may depend on the Clearing Cause and the type of calling party.

As an option the Terminating PBX may request, on call failure, that redirection be initiated by the Originating PBX. A PBX acting as an Originating PBX, however, is not

obliged to support this option and may consequently ignore such a request.

2.3 OUTLINE OF OPERATION

This facility is implemented using the following separate signal sequences:

- 2.3.1 Redirection by the Originating PBX via a Different Channel.
- 2.3.2 Redirection by the Originating PBX via the Same Channel.
- 2.3.3 Redirection Requested by the Terminating PBX.
- 2.3.4 Redirection by the Originating PBX on Call Failure.
- 2.3.5 Redirection Requested by the Terminating PBX on Call Failure.
- 2.3.6 Redirection Bypass Request.

2.3.1 REDIRECTION BY THE ORIGINATING PBX VIA A DIFFERENT CHANNEL

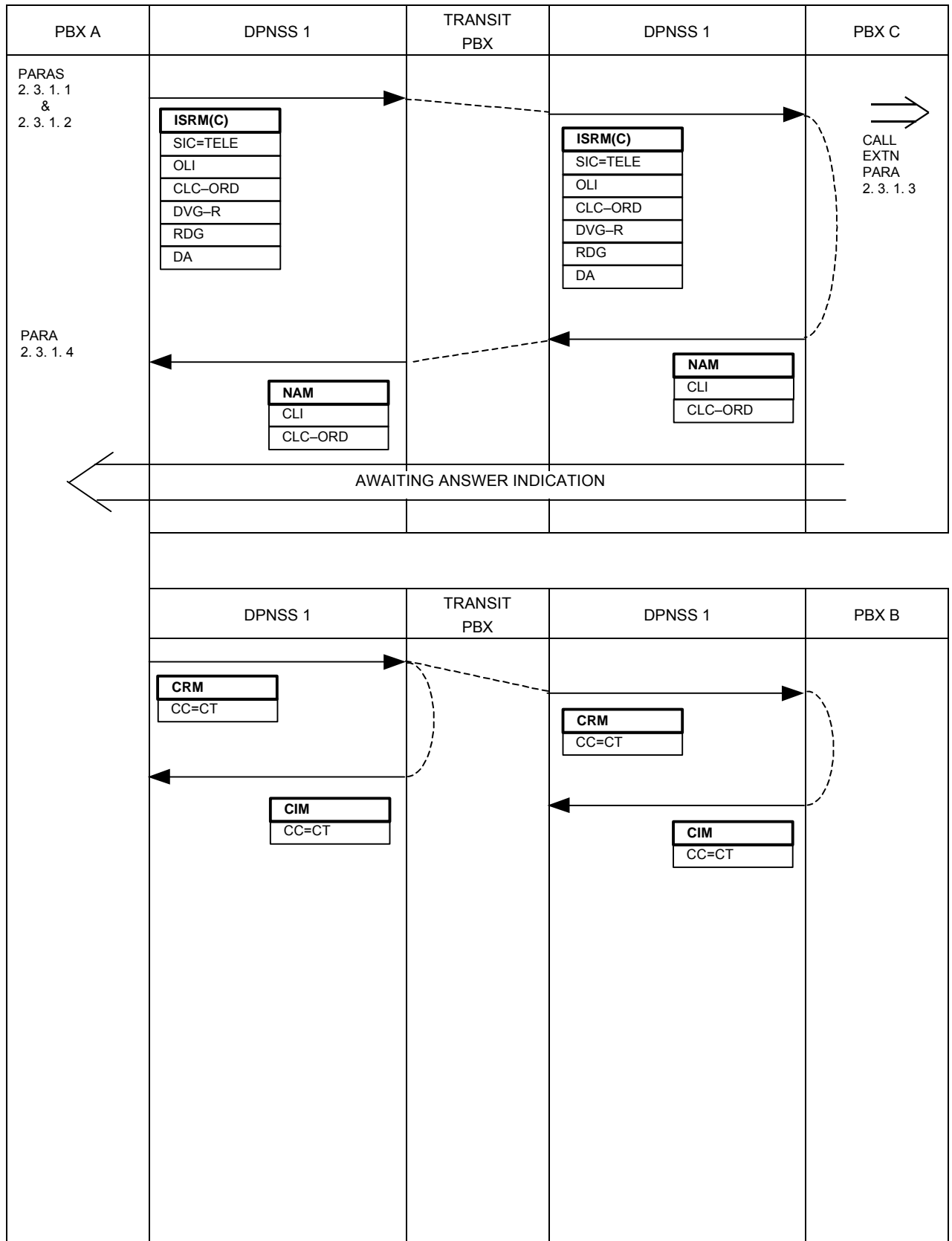

2.3.1.1 An extension on PBX A is awaiting connection or reconnection to an extension on PBX B. Depending on the state and history of the call, PBX A may decide after a certain time to redirect the call to another address. The address may be that of the party responsible for transferring the call, or it may be an address registered at PBX A for use in such a situation.

The existing call may be awaiting answer, waiting on busy (following Call Offer, Wait on Busy or Call Waiting) or may be held.

2.3.1.2 This sequence assumes that the number to redirect to is on a different route from the original call or that PBX A does not support Single-Channel Working. PBX A shall select a new outgoing channel and originate a call to the new destination, whilst maintaining the original call. Included in the ISRM shall be Strings Diverting on No Reply (DVG-R) and Redirecting (RDG). The Parameters of RDG give the following information about the redirection:

- The state of the call before redirection, ie: awaiting answer, waiting on busy or held.
- Whether the call was put into that state by means of transfer, and if so, whether the transferer was an operator or an extension and whether the call is being redirected back to the transferer.

2.3.1.3 The new call's Terminating PBX (C), on receipt of the ISRM, shall behave as for a diverting call, however, String RDG may be used to give a special indication to the called party.

2.3.1.4 On receipt of a NAM from PBX C, PBX A shall clear down the original call by sending a CRM with Clearing Cause: CT. A CIM shall be expected in response. The extension shall be connected to the new outgoing traffic channel and the new call shall continue as for a Simple Call. An indication that the call has been redirected may be given to the extension.

If the attempt to establish the new call fails for any reason, a CRM will be received. If so, a CIM shall be returned in response and the original call shall be allowed to continue, but a repeat attempt at redirection may be made later, depending on the reason for failure.

If PBX A receives a CCM from the original call before receipt of a NAM from the new call, it shall allow the original call to continue and shall clear the new call by sending a CRM with Clearing Cause: CT. A CIM shall be expected in response.

If the original call is cleared before a NAM on the new call has been received, either by receipt of a CRM on the original call or by the extension clearing, PBX A clears the new call by sending a CRM with Clearing Cause: CT.

If an EEM containing RECON is received from the original call, whilst awaiting the NAM from the redirected call, the new call shall be cleared by sending a CRM with Clearing Cause: CT. A CIM shall be expected in response and the original call shall be retained.

Similar action shall be taken if the original call was waiting on busy or held and an EEM containing SOD-F is received, indicating that the call has progressed to the awaiting answer state. In this case, the timer may be restarted to guard against no reply.

2.3.2 REDIRECTION BY THE ORIGINATING PBX VIA THE SAME CHANNEL

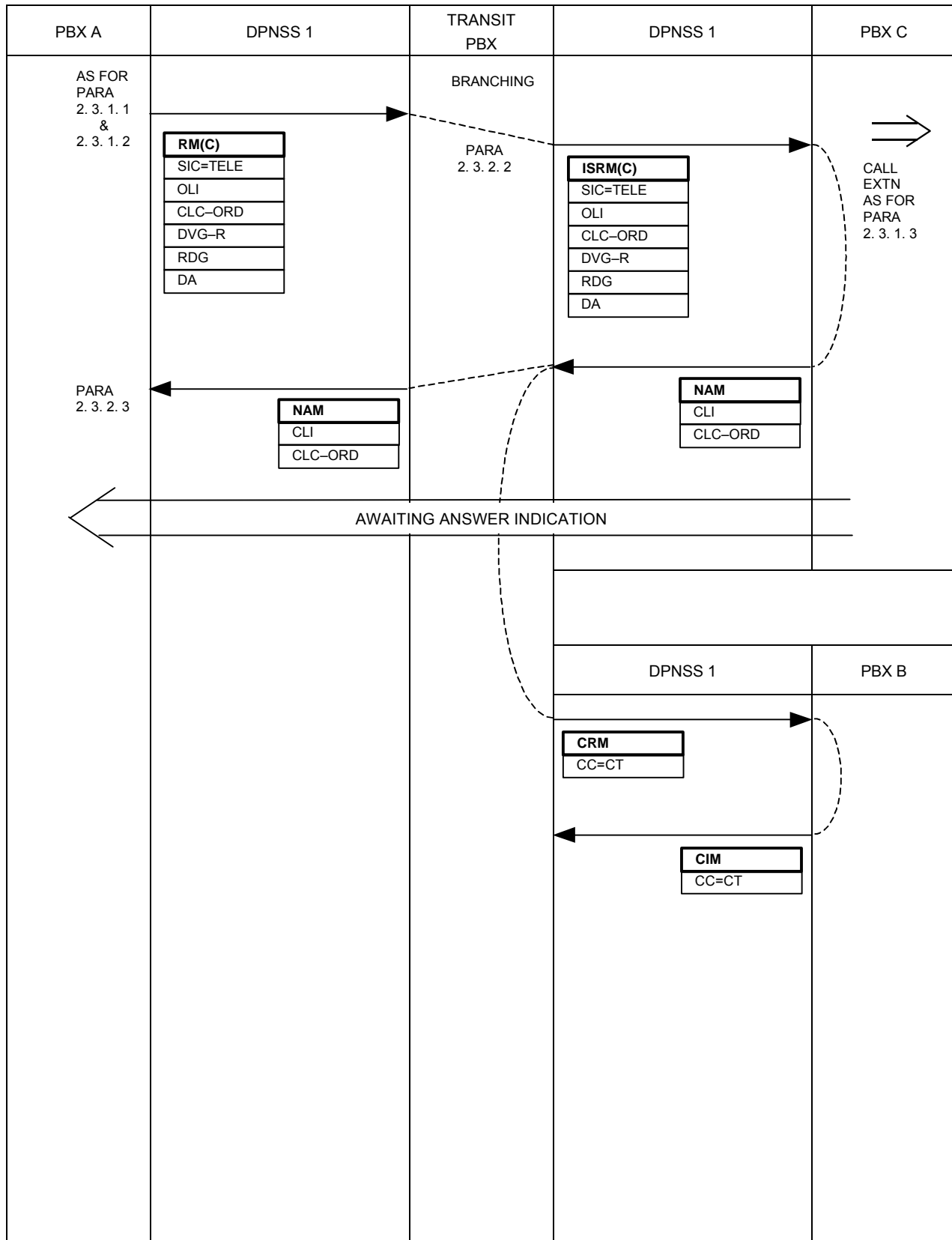

2.3.2.1 This sequence assumes that the number to redirect to is on the same route out of PBX A as the original call and that Single-Channel working is supported. An RM(C) containing DVG-R and RDG shall be sent along the existing channel. The traffic channel shall be disconnected.

2.3.2.2 The behaviour of a Transit or Branching Transit PBX on receipt of an RM(C) containing DVG-R is described in SECTION 11, paragraph 2.3.10. The additional String RDG shall simply be passed on.

2.3.2.3 Receipt of a NAM shall indicate to PBX A that redirection is complete. The traffic channel shall be reconnected.

If an RRM is received, indicating failure of the new call, the traffic channel shall be reconnected and the original call shall be allowed to continue. A repeat attempt at redirection may be made later, depending on the reason for failure.

If PBX A receives either, an EEM containing SOD-F, or a CCM, before receiving a NAM or RRM, it shall be saved; if a NAM is subsequently received, the EEM or CCM shall be discarded but if an RRM is received, the EEM or CCM shall be processed.

2.3.3 REDIRECTION REQUESTED BY TERMINATING PBX

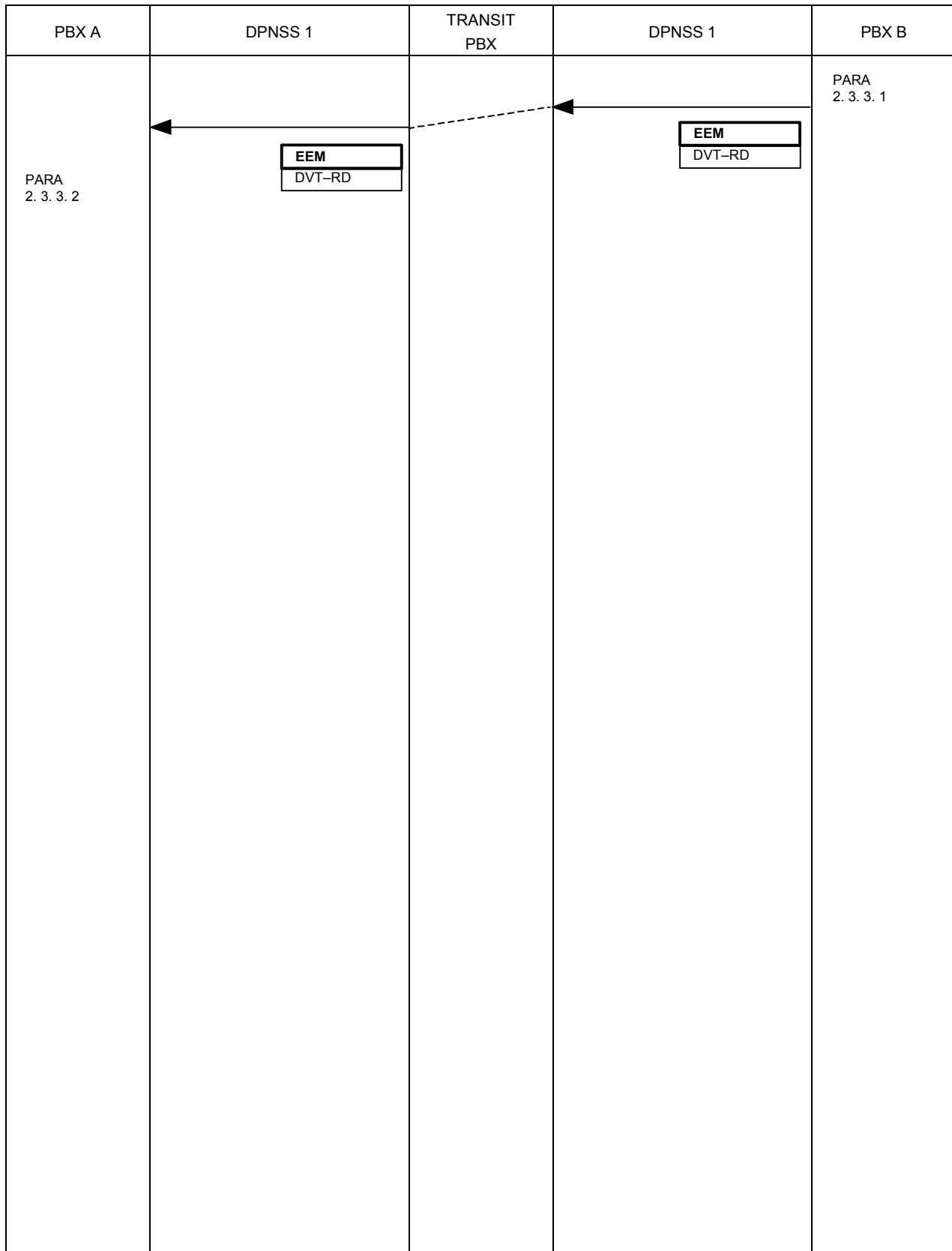

2.3.3.1 The Terminating PBX may decide that the call should be redirected to another destination. In this case the Terminating PBX shall send an EEM to the Originating PBX, containing the String Divert Redirect (DVT-RD), the Parameters of which are the reason for redirection and the new Destination Address.

2.3.3.2 On the receipt of the EEM containing DVT-RD, the Originating PBX shall redirect the call as described in paragraph 2.3.1 (via a separate channel) or 2.3.2 (via the same channel).

If the Originating PBX does not support this option, DVT-RD will not be understood and will be discarded (Informative String) and the redirection will not take place.

2.3.4 REDIRECTION BY THE ORIGINATING PBX ON CALL FAILURE

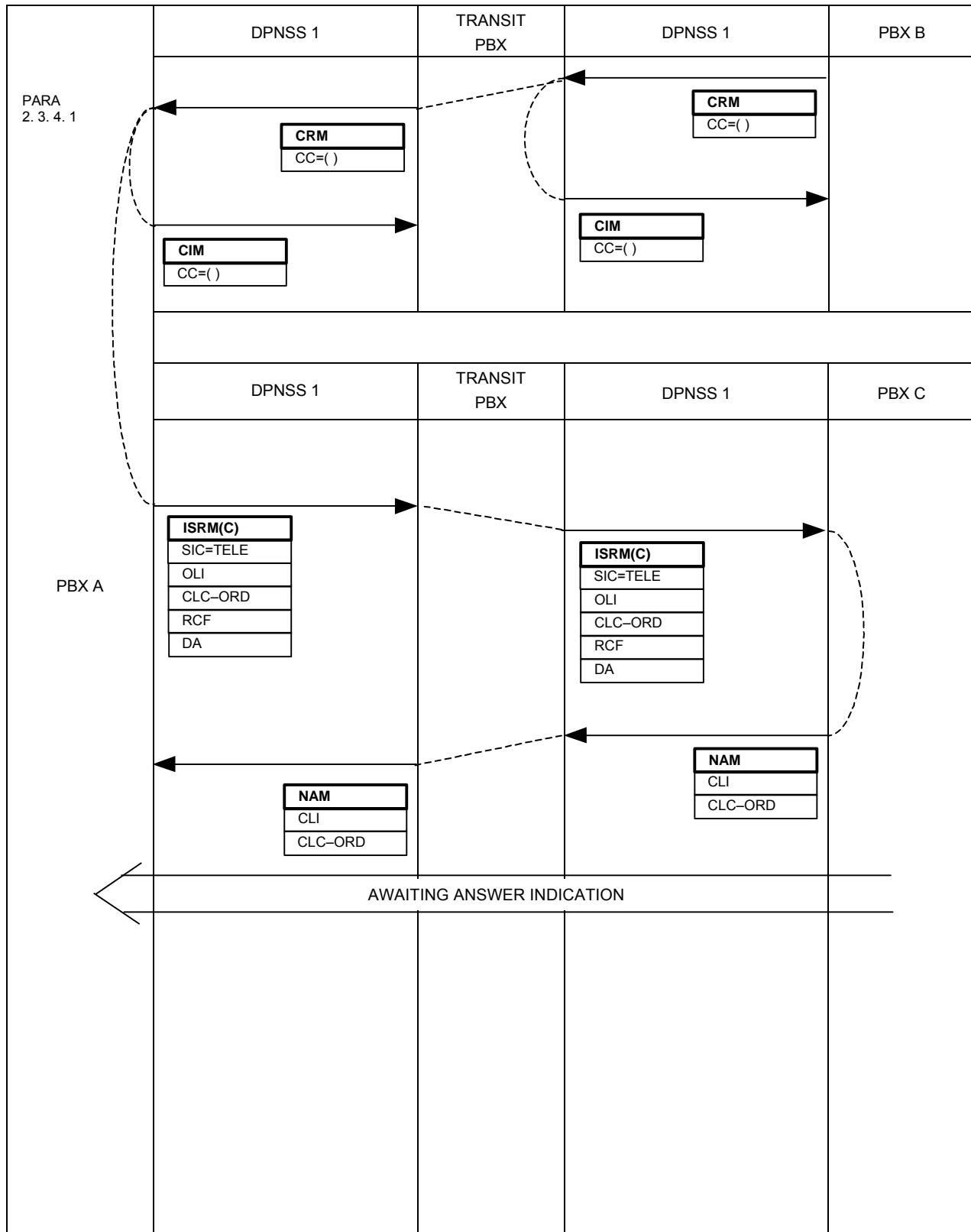

2.3.4.1 The Originating PBX of a call which has failed may, depending on the Clearing Cause and the type of calling extension, establish a new call to an alternative destination. The new call shall behave as for a Simple Call except that the ISRM shall contain the String Redirecting on Call Failure (RCF), the Parameters of which are the original Clearing Cause and the original Destination Address. This permits a special indication to be given to the called party.

2.3.5 REDIRECTION REQUESTED BY TERMINATING PBX ON CALL FAILURE

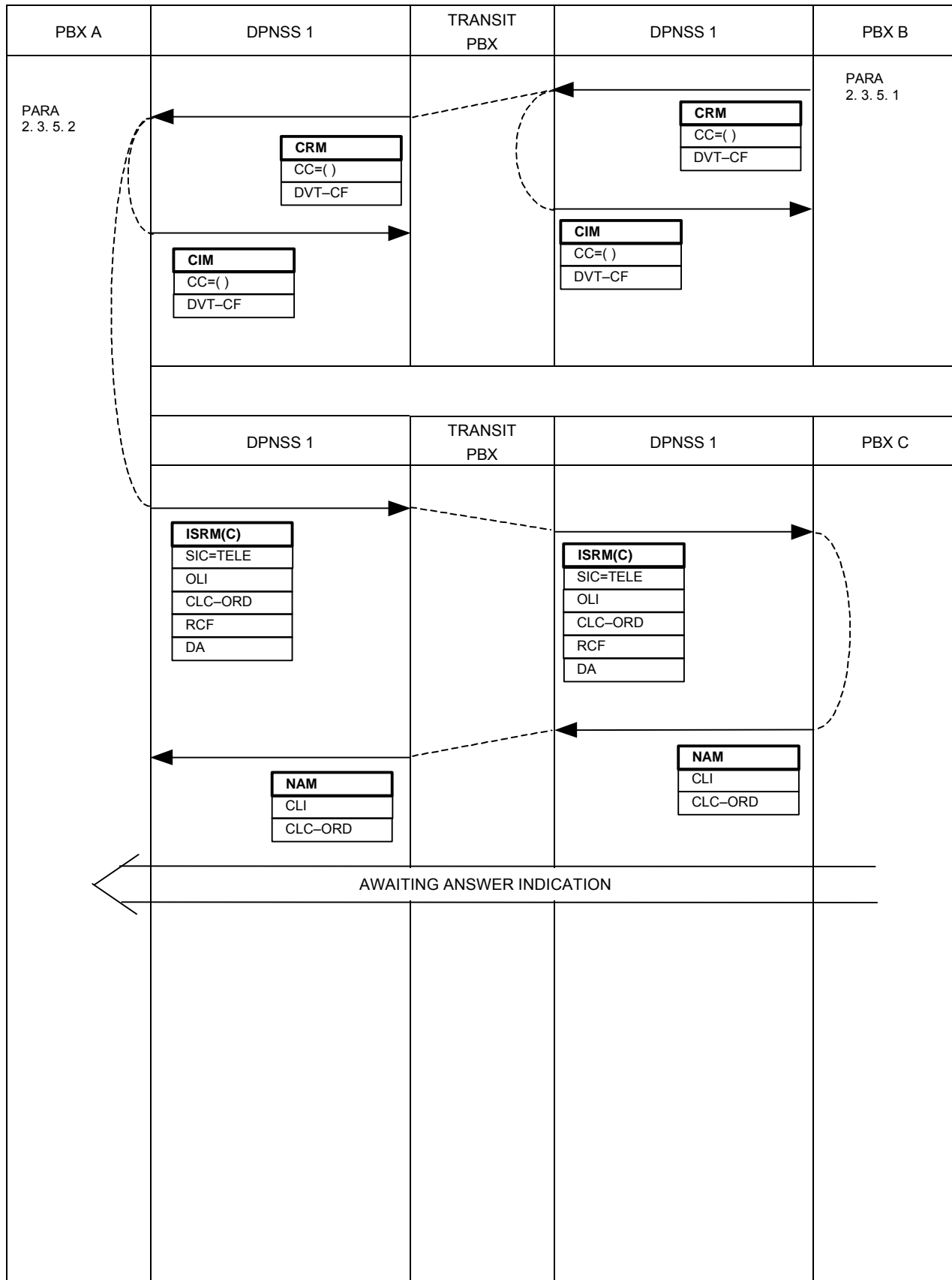

2.3.5.1 The Terminating PBX may decide that a failed call should be redirected to another destination. In this case the Terminating PBX shall send a CRM to the Originating PBX containing the appropriate Clearing Cause and the String Divert-Call Failure (DVT-CF), the Parameter of which is the new Destination Address. A CIM shall be expected in response.

2.3.5.2 On receipt of the CRM containing DVT-CF the Originating PBX shall return a CIM in response and shall redirect the call to the new Destination Address identified in the String DVT-CF. The new call shall behave as for a Simple Call, except that the ISRM shall contain the String RCF, the Parameters of which are the Clearing Cause received in the CRM and the original Destination Address.

If the Originating PBX does not support this option, String DVT-CF shall be ignored and paragraph 2.3.4.1 will apply.

2.3.6 REDIRECTION ON CALL FAILURE: BYPASS REQUEST

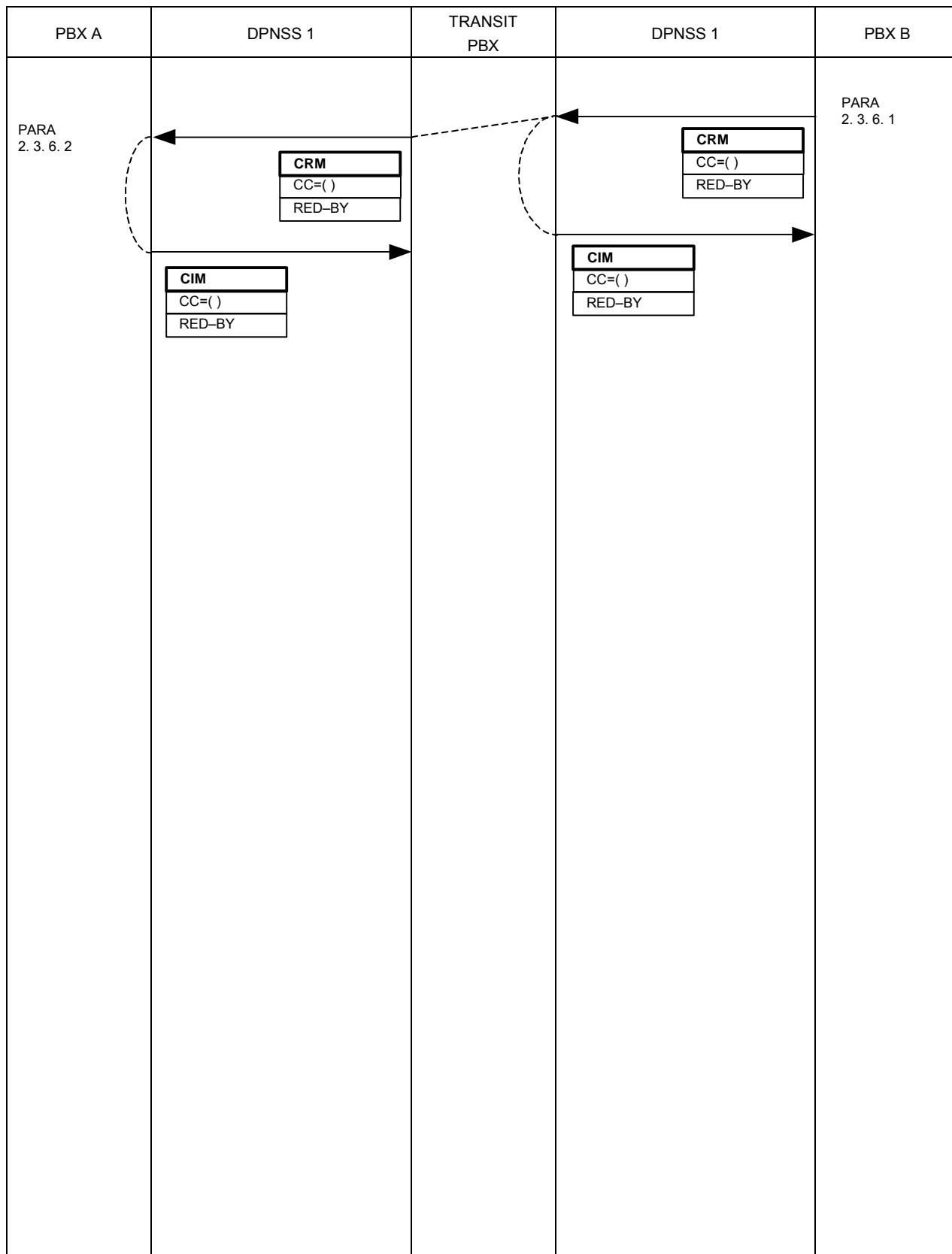

2.3.6.1 The Terminating PBX may decide that a failed call should not be redirected to another destination and may request the Originating PBX to bypass the Redirection Service. If so a CRM shall be sent to the Originating PBX containing the appropriate Clearing Cause and the String RED-BY (Redirection-Bypass). A CIM shall be expected in response.

2.3.6.2 On receipt of the CRM containing RED-BY the Originating PBX shall terminate the call.

If the Originating PBX does not support this option, the string RED-BY shall be ignored and paragraph 2.3.4.1 will apply.

3 COMPLIANCE SHEET FOR SUPPLEMENTARY SERVICE: REDIRECTION

The Redirection Supplementary Service is an optional part of DPNSS 1 and its provision on a PBX is a matter for negotiation between a customer and his supplier (see FOREWORD in SECTION 0 of this specification). This Subsection may be used as an aid to those negotiations.

NOTE: Whilst the provision of this service is optional, if it is provided, compliance with certain features of the service becomes mandatory.

Compliance with the service is considered in terms of the function(s) to be performed by the PBX, ie Transit, End or Branching, and whether the PBX can initiate the service.

The options available are given in TABLE 1. This table should be completed by a manufacturer to indicate PBX capability and by a purchaser to indicate PBX requirements.

TABLES 2 to 4 indicate the features that are required/provided at each PBX. The pre-printed "YES" indicates that the feature is a mandatory part of the service for that PBX function.

TABLE 1

PBX FUNCTION		APPLICABLE TABLE
PBX that has operators or extensions that can initiate the service		TABLES 2 & 3
PBX that has operators or extensions but cannot initiate the service		TABLE 2
Transit PBX		TABLE 4

TABLE 2

COMPLIANCE TABLE FOR A PBX WITH OPERATORS OR EXTENSIONS IN A NETWORK THAT SUPPORTS THE REDIRECTION SERVICE			
SERVICE VARIANT			COMMENT
Able to accept redirected calls from other DPNSS 1 PBXs?	via a separate channel	YES	
	via the same channel as the existing call		
Able to accept redirection information from other DPNSS 1 PBXs?			
Able to Bypass the redirection service if instructed by other DPNSS 1 PBXs?			

TABLE 3

ADDITIONAL COMPLIANCE TABLE FOR A PBX WHICH HAS OPERATORS OR EXTENSIONS AND IS ABLE TO INITIATE REDIRECTION			
SERVICE VARIANT			COMMENT
Originating PBX able to initiate a Redirected Call	via a separate channel	YES	
	via the same channel as the existing call		
Terminating PBX able to give Redirection information to other DPNSS 1 PBXs?			
Able to instruct other DPNSS 1 PBXs to Bypass the Redirection Service?			

TABLE 4

COMPLIANCE TABLE FOR A TRANSIT PBX IN A NETWORK THAT SUPPORTS REDIRECTION			
SERVICE VARIANT			COMMENT
Able to act as a Transit for redirected calls received on a new channel?		YES	Inherent DPNSS 1 Capability
Able to act as a Transit for Redirection Requests?		YES	Inherent DPNSS 1 Capability
Able to act as a Transit for Redirection Bypass Indications?		YES	Inherent DPNSS 1 Capability
Able to act as a Transit for redirected calls received on the same channel as the original call?	Non-Branching		
	Branching		

DIGITAL PRIVATE NETWORK SIGNALLING SYSTEM NO 1 (DPNSS 1)

SECTION 23 - SUPPLEMENTARY SERVICE: SERIES CALL

CONTENTS

1	GENERAL	Page 2
2	SERIES CALL WITHIN DPNSS 1	Page 3
2.1	DEFINITION.....	Page 3
2.2	DESCRIPTION.....	Page 3
2.3	OUTLINE OF OPERATION.....	Page 3
2.3.1	Series Call - Registration and Cancellation.....	Page 4
2.3.2	Series Call - Establishment.....	Page 6
3	COMPLIANCE	Page 8

HISTORY

Issue 1 - September 1984
Issue 2 - March 1986
Issue 3 - December 1989

Issue 4 - March 2001 - Specification renamed as DPNSS[188]

1 GENERAL

- 1.1** This Section details the signalling requirements of DPNSS 1 for the Series Call Supplementary Service.
- 1.2** Subsection 2 details the service within DPNSS 1.
- 1.3** Subsection 3 shows the Compliance.
- 1.4** The description is given in the form of Message Sequence Diagrams (MSD) followed by explanatory text.
- 1.5** The text is referenced from MSDs at appropriate points in the sequences.
- 1.6** Message contents for successful calls are shown in MSDs. Messages and their contents for alternative sequences (eg where this Supplementary Service is not allowed) are detailed in the text.
- 1.7** Coding of the contents of messages is given in SECTION 4.

2 SERIES CALL WITHIN DPNSS 1

2.1 DEFINITION

The Series Call Supplementary Service offers a party who is receiving assistance, and who has expressed the wish to make a series of calls, the facility to be reconnected automatically to the assistance point after each call.

2.2 DESCRIPTION

A party receiving assistance, normally from an operator, may express a wish to make a series of calls. The operator may then register a Series Call Request against that party before establishing the first call and withdrawing. When that call is terminated as a result of the called party clearing, the calling party is routed back to the operator. The operator is given an indication that a Series Call is required. The Series Call Request remains registered until either it is cancelled by the operator or the calling party clears.

2.3 OUTLINE OF OPERATION

This facility is implemented using the following separate signal sequences:

2.3.1 Series Call - Registration and Cancellation;

2.3.2 Series Call - Establishment.

NOTE: The MSDs show the assistance point as being an operator (CLC-OP), but it could be an ordinary extension (CLC-ORD).

2.3.1 SERIES CALL REGISTRATION AND CANCELLATION

a. REGISTRATION

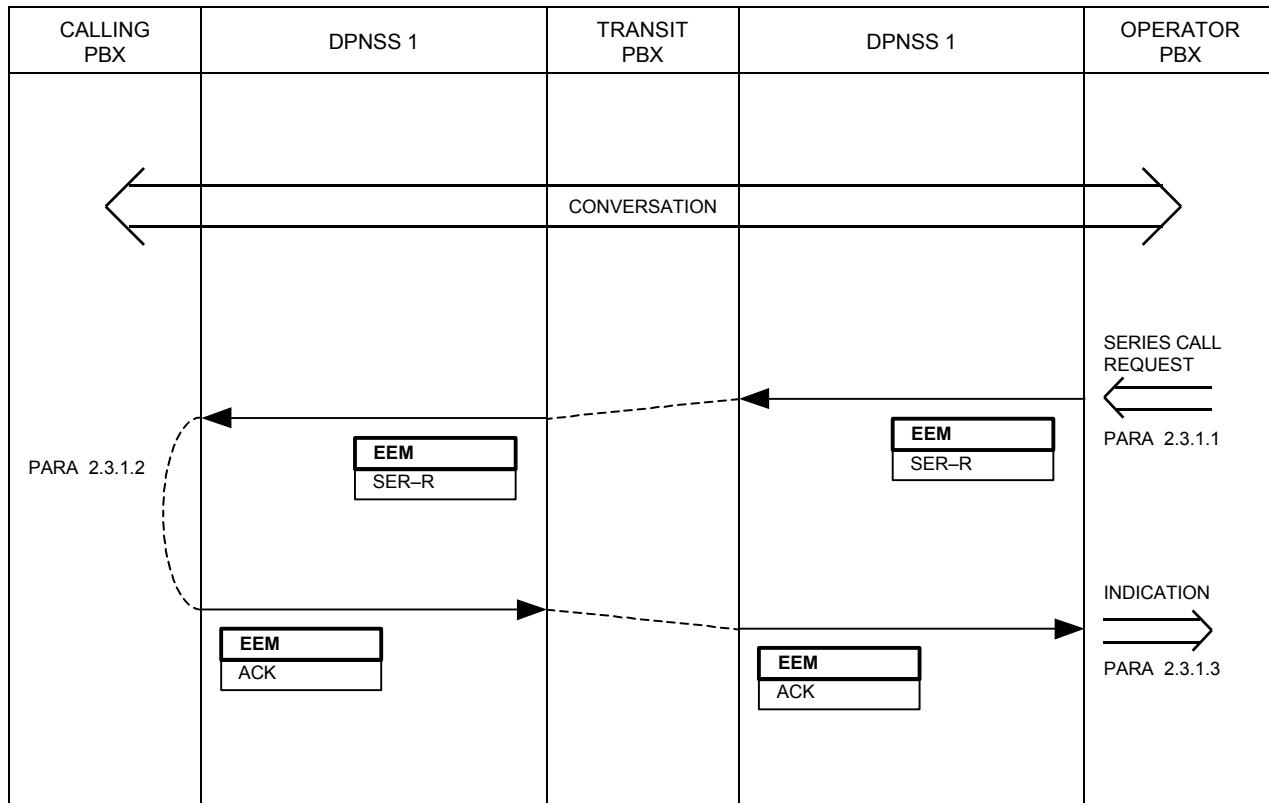

b. CANCELLATION

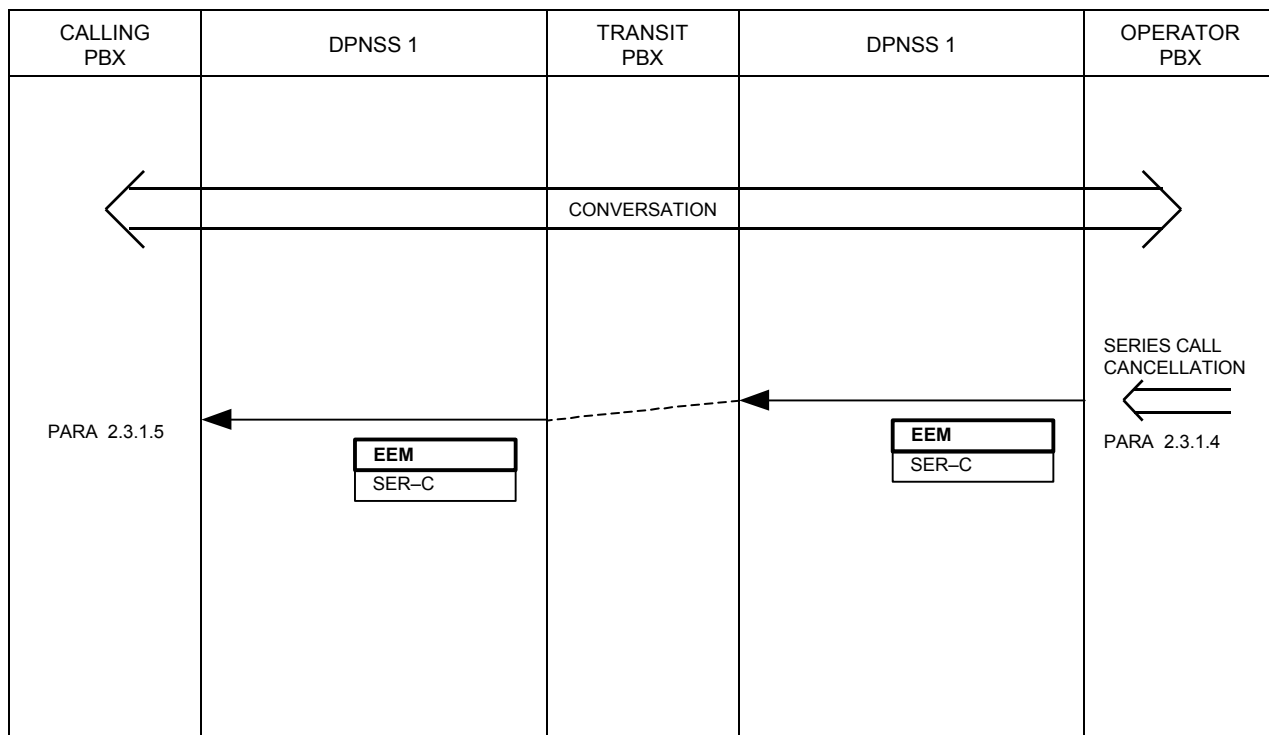

2.3.1.1 The operator, on instruction from the calling party, enters a Series Call Request. The operator PBX sends an EEM containing Series Call Request (SER-R) to the calling PBX. The Parameter of SER-R is the address to which the calling party is to be reconnected after call termination; it may be the address of the specific operator position or the address of the group of which the operator is a member.

2.3.1.2 On receipt of an EEM containing SER-R, the calling PBX registers a Series Call Request against the calling party and returns an EEM containing ACK. The request will remain registered until either the calling party clears or it is cancelled by operator action.

If the calling party is of a type which is not allowed Series Calls, an EEM containing SU is returned.

2.3.1.3 On receipt of an EEM containing ACK, the operator PBX indicates to the operator that the request has been registered.

On receipt of an EEM containing SU, the Operator PBX indicates to the operator that the request was rejected.

2.3.1.4 When the caller informs the operator that there are no more calls to be made, the operator requests Series Call Cancellation. The operator PBX sends an EEM containing Series Call Cancel (SER-C) to the calling PBX.

2.3.1.5 On receipt of an EEM containing SER-C, the calling PBX cancels any Series Call Request registered against the calling party.

2.3.2 SERIES CALL - ESTABLISHMENT

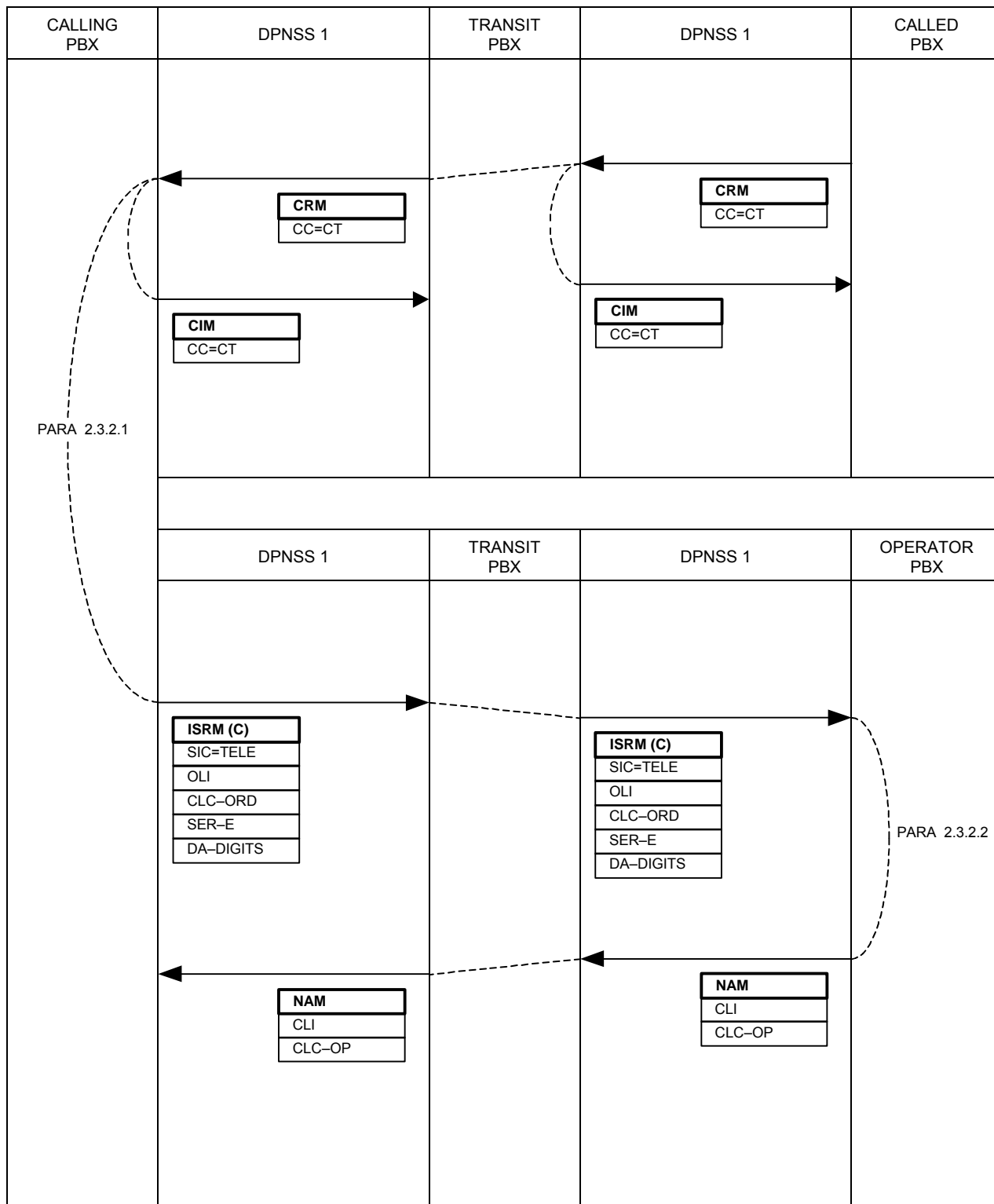

2.3.2.1 If a Series Call Request is registered against one party in a call and a CRM is received indicating that the other party has cleared, the calling PBX establishes another call to the operator. The Destination Address used is the address supplied in String SER-R when the request was registered. String SER-E is included in the ISRM.

2.3.2.2 The operator PBX handles the ISRM normally, except that String SER-E may be used to give a special indication to the operator.

3 COMPLIANCE SHEETS FOR SUPPLEMENTARY SERVICE: SERIES CALL

The Series Call Supplementary Service is an optional part of DPNSS 1 and its provision on a PBX is a matter for negotiation between a customer and his supplier (see FOREWORD in SECTION 0 of this specification). This Subsection may be used as an aid to those negotiations.

NOTE: Whilst the provision of this service is optional, if it is provided, compliance with certain features of the service becomes mandatory.

Compliance with the service is considered in terms of the function(s) to be performed by the PBX, ie Transit, End or Branching, and the extent to which operators on the PBX can request the service.

The options available are given in TABLE 1. This table should be completed by a manufacturer to indicate PBX capability and by a purchaser to indicate PBX requirements.

Tables 2 to 4 indicate the features that are required/provided at each PBX. The pre-printed "YES" indicates that the feature is a mandatory part of the service for that PBX function.

TABLE 1

PBX FUNCTION		APPLICABLE TABLE
PBX with operators some of which can request the service.		TABLE 2 & 3
PBX with extensions		TABLE 2
Transit PBX		TABLE 4

TABLE 2

COMPLIANCE TABLE FOR A PBX WITH OPERATORS OR EXTENSIONS IN A NETWORK THAT SUPPORTS SERIES CALL		
SERVICE VARIANT		COMMENT
Able to accept a Series Call - Request?	YES	
Able to accept a Series Call - Cancel?	YES	
Ability of a PBX, on a clear-down of a call, to establish automatically a new call to a specific assistance point?	YES	

TABLE 3

ADDITIONAL COMPLIANCE TABLE FOR PBXs WITH OPERATORS THAT ARE ABLE TO REQUEST SERIES CALLS		
SERVICE VARIANT		COMMENT
Able to send a Series Call - Request?	YES	
Able to send a Series Call - Cancel?	YES	
Able to accept Series Calls?	YES	

TABLE 4

COMPLIANCE TABLE FOR A TRANSIT PBX IN A NETWORK THAT SUPPORTS SERIES CALL		
SERVICE VARIANT		COMMENT
Able to transit Series Call - Requests?	YES	Inherent DPNSS 1 Capability
Able to transit Series Call - Cancel?	YES	
Able to transit Series Call Set-up?	YES	

DIGITAL PRIVATE NETWORK SIGNALLING SYSTEM NO 1 (DPNSS 1)

SECTION 24 - SUPPLEMENTARY SERVICE: THREE-PARTY TAKEOVER

CONTENTS

1	GENERAL	Page 2
2	THREE-PARTY TAKEOVER WITHIN DPNSS 1	Page 3
	2.1 DEFINITION	Page 3
	2.2 DESCRIPTION	Page 3
	2.3 OUTLINE OF OPERATION	Page 3
	2.3.1 Three-Party Takeover	Page 4
3	COMPLIANCE	Page 8

HISTORY

Issue 1 - September 1984

Issue 2 - March 1986

Issue 3 - December 1989

Issue 4 - March 2001 - Specification renamed as DPNSS[188]

1 GENERAL

1.1 This Section details the signalling requirements of DPNSS 1 for the Three-Party Takeover Supplementary Service.

1.2 Subsection 2 details the service within DPNSS 1.

1.3 Subsection 3 shows the Compliance.

1.4 The description is given in the form of Message Sequence Diagrams (MSDs) followed by explanatory text.

1.5 The text is referenced from MSDs at appropriate points in the sequences.

1.6 Message contents for successful takeovers are shown in MSDs. Message contents for alternative sequences (e.g., where this Supplementary Service is not permitted) are detailed in the text.

1.7 Coding of the contents of messages is given in SECTION 4.

2 THREE-PARTY TAKEOVER WITHIN DPNSS 1

2.1 DEFINITION

The Three-Party Takeover Supplementary Service offers a non-controlling party in a three-party situation (see SECTION 13) the capability of becoming the controlling party.

2.2 DESCRIPTION

This service, in conjunction with the Three-Party Service (SECTION 13), allows the party currently connected to the controlling party in a three-party situation to become the controlling party. The new controlling party remains connected to the original controlling party. The held party remains on hold, but for the new controlling party.

The new controlling party is then able to Shuttle, Add-on, Split, Transfer, or release either of the other two parties. The original controlling party loses these capabilities.

The Class Of Service necessary to permit a party to take control might typically be given to operators.

This service is not available while a Three-Party conference exists.

2.3 OUTLINE OF OPERATION

The facility is implemented using the following signal sequence. It is assumed that the original controlling party, the connected party (new controlling party), and the held party are all on different PBXs from the Branching PBX. If any party is on the Branching PBX then DPNSS 1 signalling between that party and the Branching PBX does not apply.

2.3.1 THREE - PARTY TAKEOVER

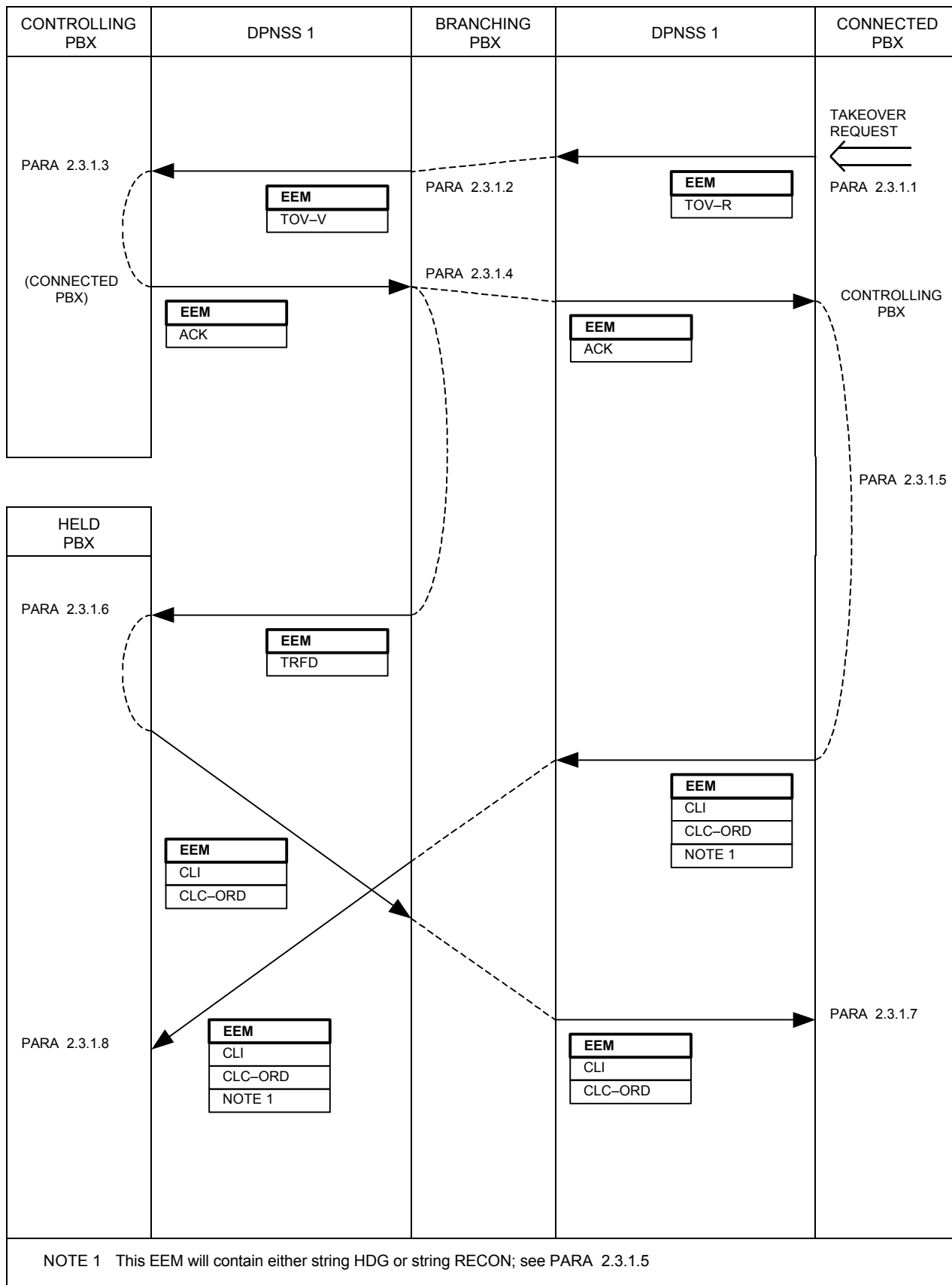

2.3.1.1 A party involved in a telephony call in which the other party is the controlling party of a three-party situation may request to become the controlling party. The requesting party's PBX will accept the request and initiate the Takeover sequence provided that the party:

- (i) has the necessary class of service,
- (ii) is engaged in a call in the speech state, and
- (iii) is not already a controlling party of a three-party situation.

An EEM containing Takeover Request (TOV-R) is sent to the Branching PBX.

Alternatively, a PBX may initiate the Takeover sequence automatically when an extension of the appropriate Class of Service answers an Enquiry call. String TOV-R is included in the CCM.

After sending a Takeover Request, the PBX must not send any further EEMs, LLMs or CCMs until a response has been received. If an EEM or LLM is received before the response to the Takeover Request, no response shall be sent until the response to the Takeover Request has been received.

2.3.1.2 On receipt of an EEM or CCM containing TOV-R from the Connected (Non-Controlling) PBX, the Branching PBX sends an EEM or CCM containing Takeover Validation (TOV-V) towards the Controlling PBX.

An EEM containing SNU would be sent in response to an EEM or CCM containing TOV-R from the Controlling PBX or the Held PBX.

2.3.1.3 On receipt of an EEM containing TOV-V, the Controlling PBX checks whether Takeover is permitted. Essentially, the held party is to be transferred to the connected party, even though it will remain on hold initially until the connected party, having become the controlling party, connects to it. Therefore, the Controlling PBX has to perform the checks it would perform if transfer were attempted.

If takeover is acceptable, the Controlling PBX returns an EEM containing ACK and ceases behaving as a Controlling PBX. Otherwise, it returns an EEM containing REJ.

2.3.1.4 On receipt of an EEM containing ACK, the Branching PBX changes over the roles of the controlling and connected parties. Note that the path to the new Controlling PBX is now in dual use and the path to the new connected party is now in single use. An EEM containing ACK is sent to the new Controlling PBX. An EEM containing TRFD is sent to the Held PBX, informing it that control has been transferred.

If an EEM containing REJ is received, it is passed on towards the Connected PBX and Takeover is aborted.

2.3.1.5 Receipt of an EEM containing ACK indicates to the Connected PBX that it is now the Controlling PBX. It sends its party's CLI and CLC to the Held PBX by means of an EEM. If the new Controlling PBX supports the Hold Service (SECTION 12) and expects the held party to be given a holding indication, it should include String Holding (HDG) in the EEM in case the old Controlling PBX did not support the service. Otherwise, it should include String Reconnected (RECON) in the EEM to ensure that any holding indication is removed.

An EEM containing REJ indicates rejection of the Takeover Request.

Receipt of an EEM containing SNU may indicate either that the Branching PBX does not support this service or that there is no three-party situation and, consequently, the EEM TOV-R found its way to the other PBX.

2.3.1.6 Receipt of an EEM containing TRFD indicates to the Held PBX that control has been transferred. It transmits its CLC and CLI to the new controlling party in an EEM.

2.3.1.7 The new Controlling PBX receives the held party's CLC and CLI in an EEM.

2.3.1.8 The Held PBX receives the new controlling party's CLC and CLI in an EEM. Holding indication is connected or disconnected according to whether the EEM contains HDG or RECON.

2.3.1.9 The following interactions with the Three-Party Service may occur:

2.3.1.9.1 The Branching PBX receives a CRM from the Held PBX while awaiting the EEM containing ACK from the Controlling PBX. The Branching PBX handles the clear in the normal way and aborts Takeover. An EEM containing REJ is sent to the Connected PBX.

2.3.1.9.2 The Branching PBX receives a CRM from the Connected PBX while awaiting the EEM containing ACK from the Controlling PBX. The Branching PBX handles the clear in the normal way and aborts Takeover.

2.3.1.9.3 The Branching PBX receives an SCRM containing COC from the Controlling PBX while awaiting the EEM containing ACK from the Controlling PBX. The SCRM is handled normally and Takeover is aborted. The Controlling PBX will ignore the TOV-V.

2.3.1.9.4 The Branching PBX receives an SCRM without COC from the Controlling PBX while awaiting the EEM containing ACK from the Controlling PBX. The SCRM is handled normally, Takeover is aborted and an EEM containing REJ is sent to the Connected PBX. The Controlling PBX will ignore the TOV-V.

2.3.1.9.5 The Branching PBX receives an EEM containing SHTL from the Controlling PBX while awaiting the EEM containing ACK from the Controlling PBX. The Shuttle Request is handled normally. Takeover is aborted and an EEM containing REJ is sent to the Connected PBX. The Controlling PBX will ignore the EEM containing TOV-V.

2.3.1.9.6 The Branching PBX receives an EEM containing TRFR from the Controlling PBX while awaiting a response to Takeover Validation. The Transfer Request is handled normally. If the Transfer Request is accepted, Takeover shall be aborted; receipt of an EEM containing TRFD indicates to the Connected PBX that Takeover has been aborted. If the Transfer Request is rejected, the Branching PBX shall continue to await the response to Takeover Validation.

2.3.1.9.7 The Controlling PBX receives an EEM containing TOV-V after having sent an EEM containing TRFR. It shall respond normally to the EEM containing TOV-V (as for paragraph 2.3.1.3) but continue to await the response to the EEM containing TRFR.

2.3.1.9.8 The Branching PBX receives an EEM containing AD-RQ from the Controlling PBX while awaiting the EEM containing ACK from the Controlling PBX. The Add-on Request is handled normally and Takeover is aborted. Receipt of an EEM containing AD-V indicates to the Connected PBX that Takeover has been aborted.

2.3.1.9.9 The Branching PBX receives an EEM containing TOV-R from the Connected PBX after sending to the Connected PBX an EEM containing AD-V, but before receiving a response. The Takeover Request is ignored.

3 COMPLIANCE SHEET FOR SUPPLEMENTARY SERVICE: THREE-PARTY TAKEOVER

The Three-Party Takeover Service is an optional part of DPNSS 1 and its provision on a PBX is a matter for negotiation between a customer and his supplier (see FOREWORD in SECTION 0 of this specification). This Subsection may be used as an aid to those negotiations.

NOTE: Whilst the provision of this service is optional, if it is provided, compliance with certain features of the service becomes mandatory.

Compliance with the service is considered in terms of the function(s) to be performed by the PBX, i.e. Transit, End or Branching, and the extent to which an operator or extensions on the PBX can request the service.

The options available are given in TABLE 1. This table should be completed by a manufacturer to indicate PBX capability and by a purchaser to indicate PBX requirements.

TABLES 2 to 4 indicate the features that are required/provided at each PBX. The pre-printed "YES" indicates that the feature is a mandatory part of the service for that PBX function.

TABLE 1

PBX FUNCTION		APPLICABLE TABLE
PBX with operators or extensions, some of which can request the service		TABLES 2 & 3
PBX with extensions that support the Three-Party Service none of which can request the Three-Party Takeover		TABLE 2
Transit PBX		TABLE 4

TABLE 2

COMPLIANCE TABLE FOR A PBX WITH OPERATORS OR EXTENSIONS IN A NETWORK THAT SUPPORTS THREE-PARTY TAKEOVER		
SERVICE VARIANT		COMMENT
Able as a Three-Party Controlling PBX to process a Three Party Takeover - Request (Branching at Controlling PBX)?	YES	Controlling PBX enters similar state as if it had accepted a Single-Channel Enquiry Call
Able as a Three-Party Controlling PBX to process a Three Party Takeover - Validation (Branching not at Controlling PBX)?		Mandatory if Single-Channel Enquiry is supported
Able as a Three-Party Held PBX to respond correctly to the transferred indication?	YES	(Three-Party Service)

TABLE 3

ADDITIONAL COMPLIANCE TABLE FOR A PBX WITH AN OPERATOR OR EXTENSIONS THAT ARE ABLE TO REQUEST THREE PARTY TAKEOVER		
SERVICE VARIANT		COMMENT
Able to send a Three Party Takeover Request to another DPNSS 1 PBX?	YES	Requesting PBX enters similar state as if it had made a Single-Channel Enquiry Call
Able to send a Three Party Takeover Validation to another DPNSS 1 PBX (when the operator is on the Branching PBX)?		Mandatory if Single-Channel Enquiry is supported

TABLE 4

COMPLIANCE TABLE FOR A TRANSIT PBX IN A NETWORK THAT SUPPORTS THREE-PARTY TAKEOVER		
SERVICE VARIANT		COMMENT
Able, as a Three-Party Branching Transit, to process a Three-Party Takeover - Request?		Mandatory if Branching for Three-Party Service is supported
Able, as a simple Transit, to pass on messages relating to the Three-Party Takeover Service?	YES	Inherent DPNSS 1 Capability

DIGITAL PRIVATE NETWORK SIGNALLING SYSTEM NO 1 (DPNSS 1)

SECTION 25 - SUPPLEMENTARY SERVICE: NIGHT SERVICE

CONTENTS

1	GENERAL	Page 2
2	NIGHT SERVICE WITHIN DPNSS 1	Page 3
2.1	DEFINITION	Page 3
2.2	DESCRIPTION	Page 3
2.3	OUTLINE OF OPERATION	Page 4
2.3.1	Night Service - Notification	Page 5
2.3.2	Night Service - Diversion via a Different Channel	Page 7
2.3.3	Night Service - Diversion via the Same Channel	Page 10
2.3.4	Night Service - Diversion on the Same PBX	Page 12
2.3.5	Night Service - Rediversion via a Different Channel	Page 14
2.3.6	Night Service - Rediversion via the Same Channel	Page 17
2.3.7	Night Service - Rediversion on the Same PBX	Page 18
3	COMPLIANCE	Page 19

HISTORY

Issue 1 - September 1984
Issue 2 - March 1986
Issue 3 - December 1989

Issue 4 - March 2001 - Specification renamed as DPNSS[188]
- Clearing during DVG-R Call Set Up added

1 GENERAL

- 1.1** This Section details the signalling requirements of DPNSS 1 for the Night Service Supplementary Service.
- 1.2** Subsection 2 details the service within DPNSS 1.
- 1.3** Subsection 3 shows the Compliance.
- 1.4** The description is given in the form of Message Sequence Diagrams (MSDs) followed by explanatory text.
- 1.5** The text is referenced from MSDs at appropriate points in the sequences.
- 1.6** Message contents for successful calls are shown in MSDs. Messages and their contents for alternative sequences (e.g., when Night Mode has been deactivated) are detailed in the text.
- 1.7** Coding of the contents of messages is given in SECTION 4.

2 NIGHT SERVICE WITHIN DPNSS 1

2.1 DEFINITION

The Night Service Supplementary Service provides alternative answering arrangements for calls to operators at times when normal operator positions are unattended.

2.2 DESCRIPTION

An operator group or specific position can be put into Night Mode when unattended. There are several possible methods of activating and deactivating Night Mode. For example, each operator position may be switched into or out of Night Mode; an operator group is in Night Mode when all the positions in the group are in Night Mode. Alternatively, Night Mode may be activated and deactivated at particular times of day.

The Class Of Service of some extensions and the behaviour of some trunks may vary according to whether Night Mode is active. For this reason, a Night Service Notification facility permits designated PBXs to be informed if an operator group or position changes into or out of Night Mode.

A call to an operator group or specific position which is in Night Mode may need to be diverted to a night answering point, which may be one of the following:

- Another operator group or specific position,
- An extension or group of extensions,
- A night bell (for Dial Answer Night Service).

The address of the night answering point may be provided by the Operator PBX. Alternatively, the Originating PBX may provide an address, depending on the calling party. Some calling parties may not be allowed Night Service and their calls will be rejected.

Calls to a busy night answering point should be queued.

A call already queued for an operator may be diverted to a night answering point if Night Mode is activated before the call is answered.

Calls ringing or queued for a night answering point may be rediverted back to the operator if Night Mode is deactivated.

The probability of blocking may be reduced if a diverted call uses some or all of the existing path when it follows the best available route towards the new destination (Single-Channel Working).

This service does not provide for a night bell call being picked up by an extension on a different PBX from the night bell.

Extension-Controlled Temporary Night Service is possible only if the extension and the nominated trunks are on the same PBX. No facility is provided for an extension to nominate a trunk on a different PBX.

2.3 OUTLINE OF OPERATION

This facility is implemented using the following separate signal sequences.

- 2.3.1 Night Service - Notification.
- 2.3.2 Night Service - Diversion via a Different Channel.
- 2.3.3 Night Service - Diversion via the Same Channel.
- 2.3.4 Night Service - Diversion on the Same PBX.
- 2.3.5 Night Service - Rediversion via a Different Channel
- 2.3.6 Night Service - Rediversion via the Same Channel.
- 2.3.7 Night Service - Rediversion on the Same PBX.

The MSDs show the night answering point as being an ordinary extension (CLC-ORD). If the night answering point is another operator group or specific position, CLC-OP should be used instead.

The text describes the case of an operator group being in Night Mode. However, the same rules apply in the case of a specific operator position.

2.3.1 NIGHT SERVICE - NOTIFICATION

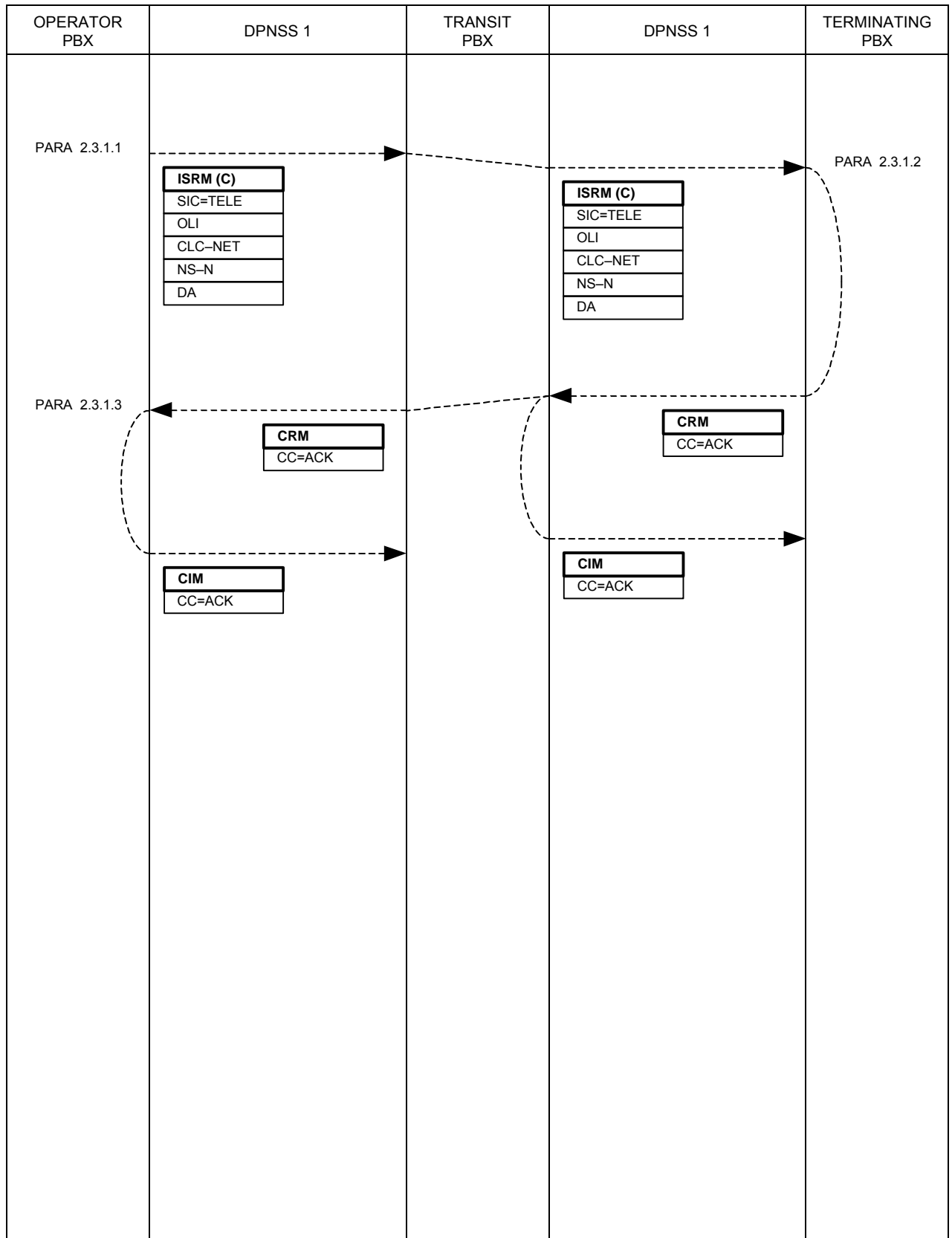

2.3.1.1 Against an operator group there may be registered a list of PBXs which need to be informed of Night Mode activation or deactivation. When activation or deactivation occurs, the operator PBX makes a Virtual Call to each PBX in the list informing it of the activation or deactivation.

To make a call, the operator PBX selects a free Virtual Channel on the appropriate outgoing route and sends an ISRM containing Night Service Notification (NS-N), the Parameter of which indicates whether Night Mode has been activated or deactivated. The Destination Address must be sufficient to route the call across the network to the Destination PBX and indicate to that PBX that the Night Service Notification facility is being addressed. String OLI conveys the address of the operator group which has changed state.

2.3.1.2 On receipt of an ISRM containing NS-N, the Night Service PBX records the new state and takes any other necessary action, e.g., changes Classes Of Service. The call is cleared by sending a CRM with Clearing Cause: Acknowledgement (ACK).

2.3.1.3 Any Clearing Cause other than ACK indicates a failure. In some cases, the operator PBX may make a repeat attempt later.

2.3.2 NIGHT SERVICE - DIVERSION VIA DIFFERENT CHANNEL

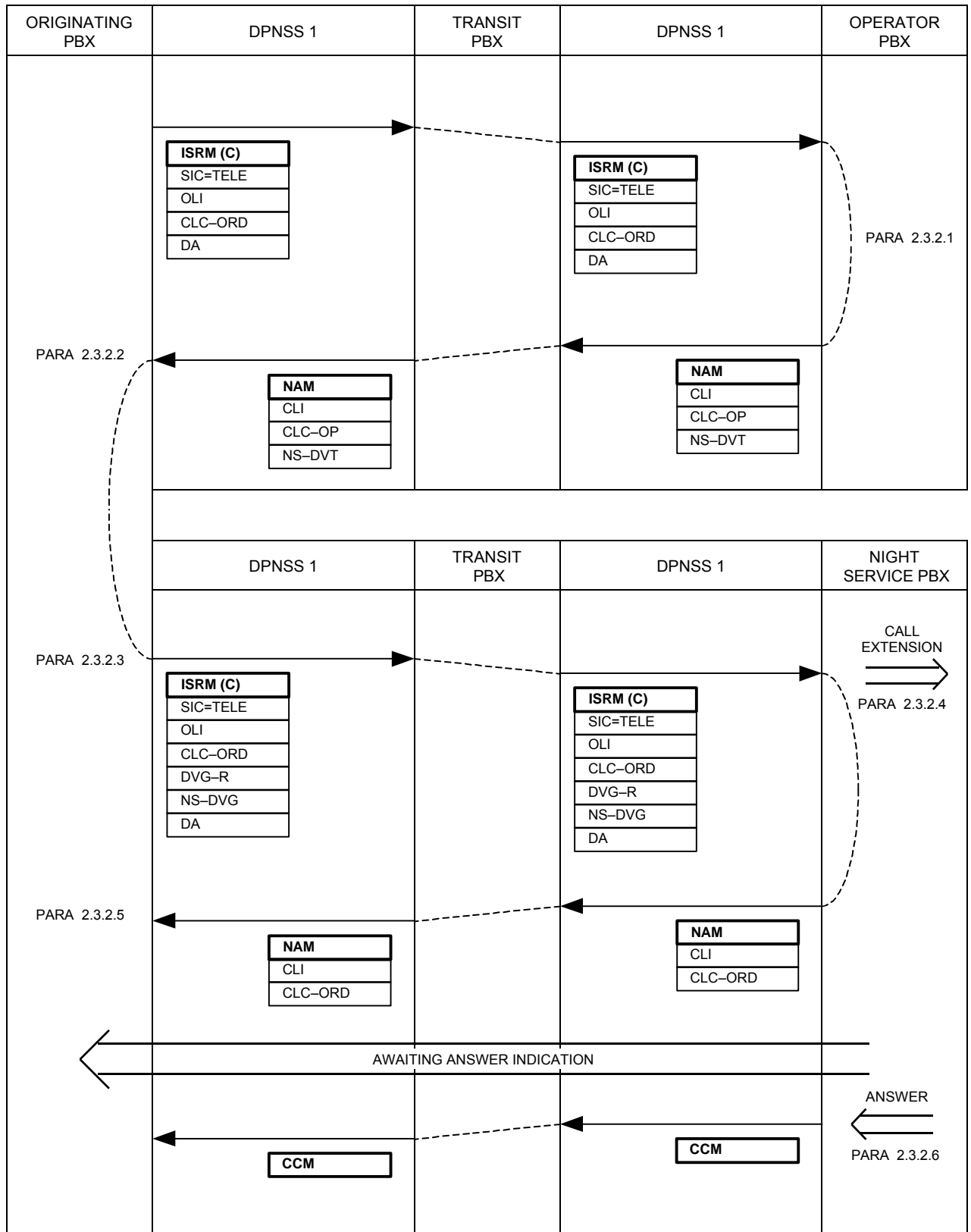

2.3.2.1 On receipt of an ISRM, if the Destination Address indicates an operator group which has Night Mode active, a NAM containing Night Service Divert (NS-DVT) is returned. Awaiting Answer indication is not applied. Alternatively, if Night Mode is activated after the NAM has been sent but before answer, an EEM containing NS-DVT is sent and Awaiting Answer indication continues to be applied.

NOTE: In the following paragraphs, it is assumed that the party switched into Night Mode is an operator. The party switched into Night Mode could equally well be an ordinary extension. The signalling encountered will be identical except that CLC-ORD will be used in place of CLC-OP.

If the Operator PBX is able to supply the address of a Night Service point, it includes it as a Parameter of NS-DVT.

The Operator PBX expects to receive a CRM with Clearing Cause: Call Termination (CT) when diversion has taken place. However, on receipt of an EEM containing SU or IG-SNU, indicating that diversion is not taking place, the Operator PBX should apply Awaiting Answer Indication (if not already being applied) and maintain the call in the hope that Night Mode will be deactivated again.

In the event of Night Mode being deactivated before receipt of a CRM, the Operator PBX sends an EEM containing Night Service Deactivated (NS-DA), applies Awaiting Answer Indication (if not already being applied), and presents the call to the operator.

2.3.2.2 Receipt of String NS-DVT in the NAM or in an EEM after the NAM indicates to the Originating PBX that Night Mode is active. The Originating PBX must decide, depending on the calling line, whether to divert the call and to what address. If String NS-DVT contains the address of a night answer point, that may be used. Alternatively, there may be an address registered at the Originating PBX; the address may be calling-line dependent. If both are available, the Originating PBX must choose one.

If there is no address available, or if the particular type of calling line is not to be diverted, the Originating PBX may either clear the call and give a suitable indication to the calling party or return an EEM containing SU and leave the call established in the hope that Night Mode will be deactivated again (indicated by receipt of an EEM containing NS-DA).

2.3.2.3 This sequence assumes that the number to divert to is on a different route from that of the original call or that the Originating PBX does not support Single-Channel Working. The Originating PBX selects a free outgoing channel and sends an ISRM containing Strings Diverting on No Reply (DVG-R) and Night Service Diverting (NS-DVG) in addition to the normal ISRM contents.

2.3.2.4 On receipt of an ISRM containing NS-DVG at the Night Service PBX, if the night-answering point is free, it is called. Otherwise, the call should be queued. Awaiting Answer Indication is applied and a NAM is returned. The NAM contains String Call Waiting (CW) if the call is queued.

Rejection with Clearing Cause: Busy (BY) will occur only if the call cannot be queued.

2.3.2.5 On receipt of a NAM, the Originating PBX clears the original call by sending a CRM with Clearing Cause: CT.

On receipt of a CRM, indicating failure of the diverting call, the Originating PBX may either clear the original call and give a suitable indication to the calling party or leave the original call established and send an EEM containing SU. If the call is left established, the Originating PBX may make repeat attempts at diverting at suitable intervals, depending on the reason for failure.

Receipt of an EEM containing NS-DA from the Operator PBX indicates that Night Mode has been deactivated and there is no longer any need to divert. If an EEM containing NS-DA is received during an attempt at diverting, the new call is cleared by sending a CRM with Clearing Cause: CT and the original call is allowed to continue.

If the original call is cleared before a NAM on the new call has been received, either by receipt of a CRM on the original call or by the calling party clearing, the new call is cleared by sending a CRM with Clearing Cause: CT.

2.3.2.6 A CCM is sent on answer. In the case of night-bell answer, the CLI of the extension which picked up the call is included in the CCM.

If the call is queueing for a busy Night Service point and the Night Service point becomes free, an EEM containing SOD-F is sent. This is followed by a CCM on answer.

2.3.3 NIGHT SERVICE - DIVERSION VIA THE SAME CHANNEL

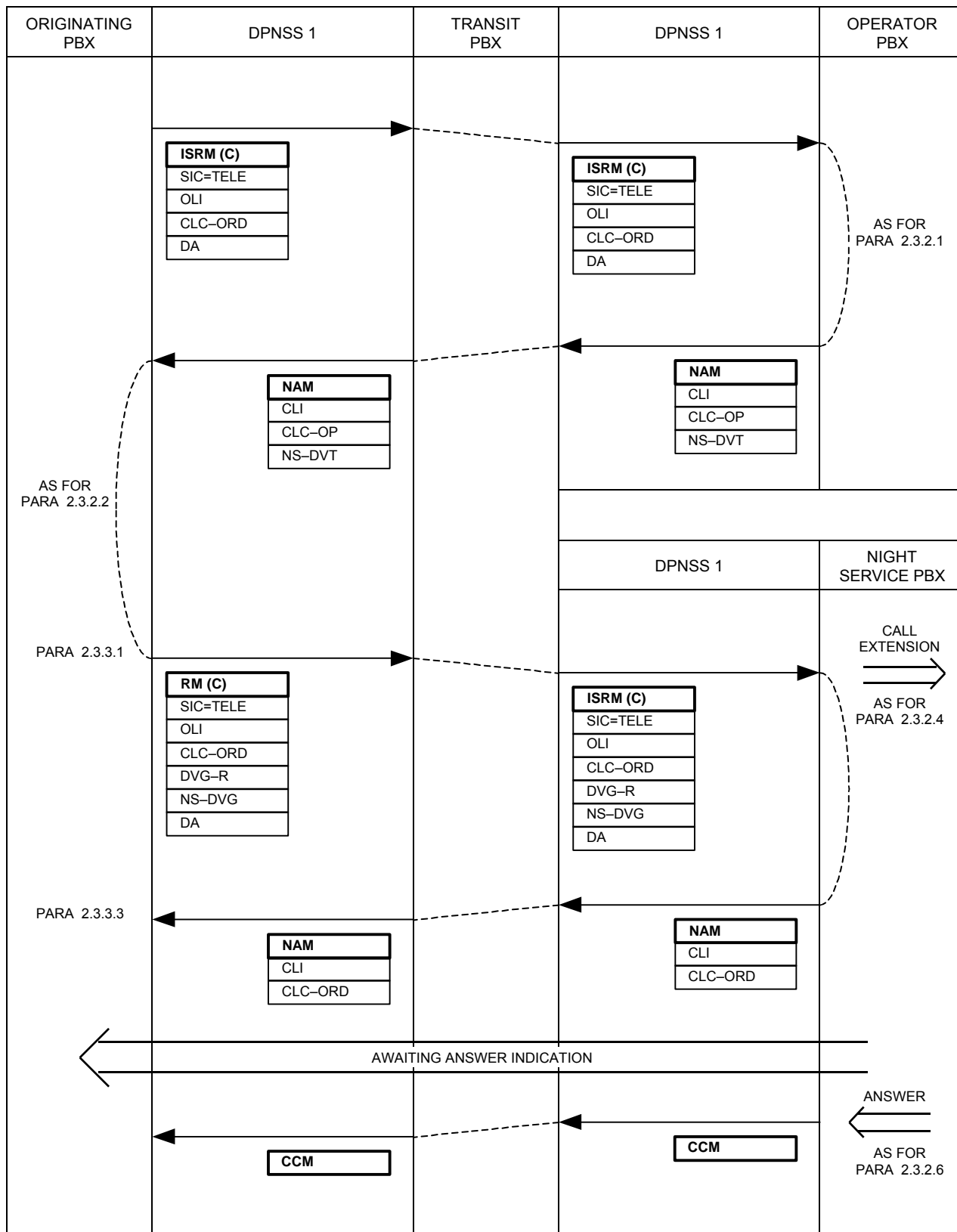

2.3.3.1 The sequence assumes that the number to divert to is on the same route out of the Originating PBX as the original call and that Single-Channel Working is supported. An RM(C) containing DVG-R and NS-DVG is sent along the existing channel. The traffic channel is disconnected.

NOTE: In the following paragraphs, it is assumed that the party switched into Night Mode is an operator. The party switched into Night Mode could equally well be an ordinary extension. The signalling encountered will be identical except that CLC-ORD will be used in place of CLC-OP.

2.3.3.2 The behaviour of a Transit or Branching Transit PBX on receipt of an RM(C) containing DVG-R is described in SECTION 11, paragraph 2.3.10. The additional String NS-DVG is simply passed on.

2.3.3.3 Receipt of a NAM indicates to the originating PBX that diversion is complete. The traffic channel is reconnected.

On receipt of an RRM, indicating failure of the new call, the Originating PBX may either clear the original call and give a suitable indication to the calling party or reconnect the traffic channel, leave the original call established and send an EEM containing SU. If the call is left established, the Originating PBX may make repeat attempts at diverting at suitable intervals, depending on the reason for failure.

Receipt of an EEM containing NS-DA indicates that Night Mode has been deactivated and there is no longer any need to divert. If an EEM containing NS-DA is received during an attempt at diverting, it is saved; if the attempt succeeds, the EEM is discarded, but if it fails, the EEM can be processed.

2.3.4 NIGHT SERVICE – DIVERSION ON THE SAME PBX

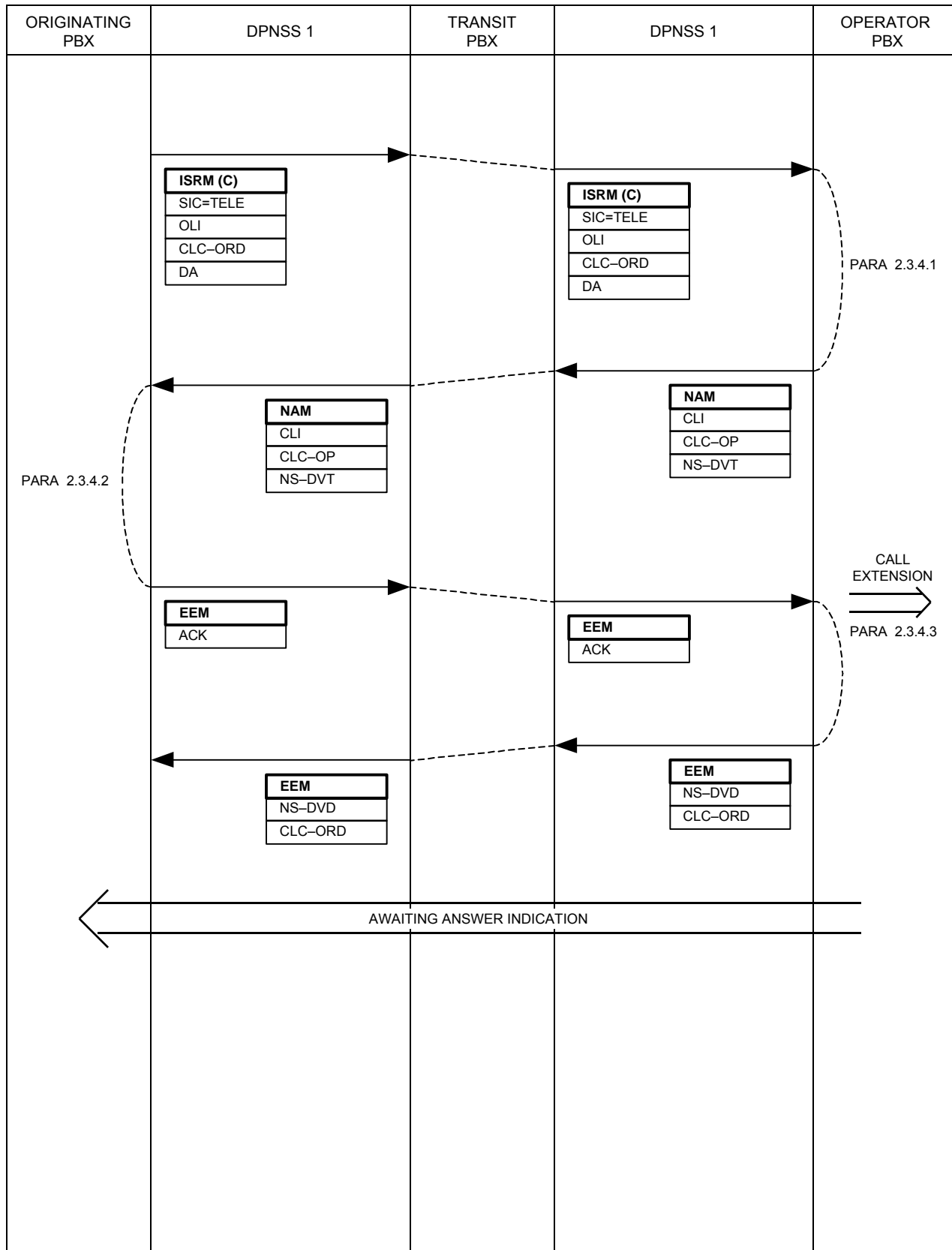

2.3.4.1 When the Operator PBX sends a NAM or EEM containing NS-DVT, if String NS-DVT contains the address of a night service point on the same PBX, an additional Parameter is included to indicate that the proposed diversion is on-PBX.

2.3.4.2 On receipt of a NAM or EEM containing NS-DVT, if the Originating PBX chooses to divert to the address in String NS-DVT and that address is indicated as being on the same PBX as the operator, an EEM containing ACK is sent back to the Operator PBX.

Alternatively, the Originating PBX may choose to divert to a different address using the procedures described in paragraphs 2.3.2 and 2.3.3, clear the call and give a suitable indication to the calling party, or return an EEM containing SU and leave the call established in the hope that Night Mode will be deactivated again.

2.3.4.3 On receipt of an EEM containing ACK, the Operator PBX diverts the call to the night service point, queueing if necessary, and applies Awaiting Answer Indication. An EEM containing Night Service - Diverted (NS-DVD) and the CLC of the new destination is returned. The Parameter of NS-DVD contains the identity of the new destination. If the night service point is busy, but the call can be queued, String CW is included in the EEM. Similar action is taken on receipt of an EEM containing IG-SNU.

On receipt of an EEM containing SU, indicating that diversion is not required, the operator PBX should apply Awaiting Answer Indication (if not already being applied) and maintain the call in the hope that Night Mode will be deactivated again.

If, when the EEM containing ACK is received, the operator PBX is unable to divert, it may try again at intervals and return an EEM containing NS-DVD when successful.

If Night Mode is deactivated before diversion, whether or not an EEM containing ACK has been received, the operator PBX sends an EEM containing NS-DA, applies Awaiting Answer Indication (if not already applied) and presents the call to the operator.

2.3.5 NIGHT SERVICE – REDIVERSION VIA A DIFFERENT CHANNEL

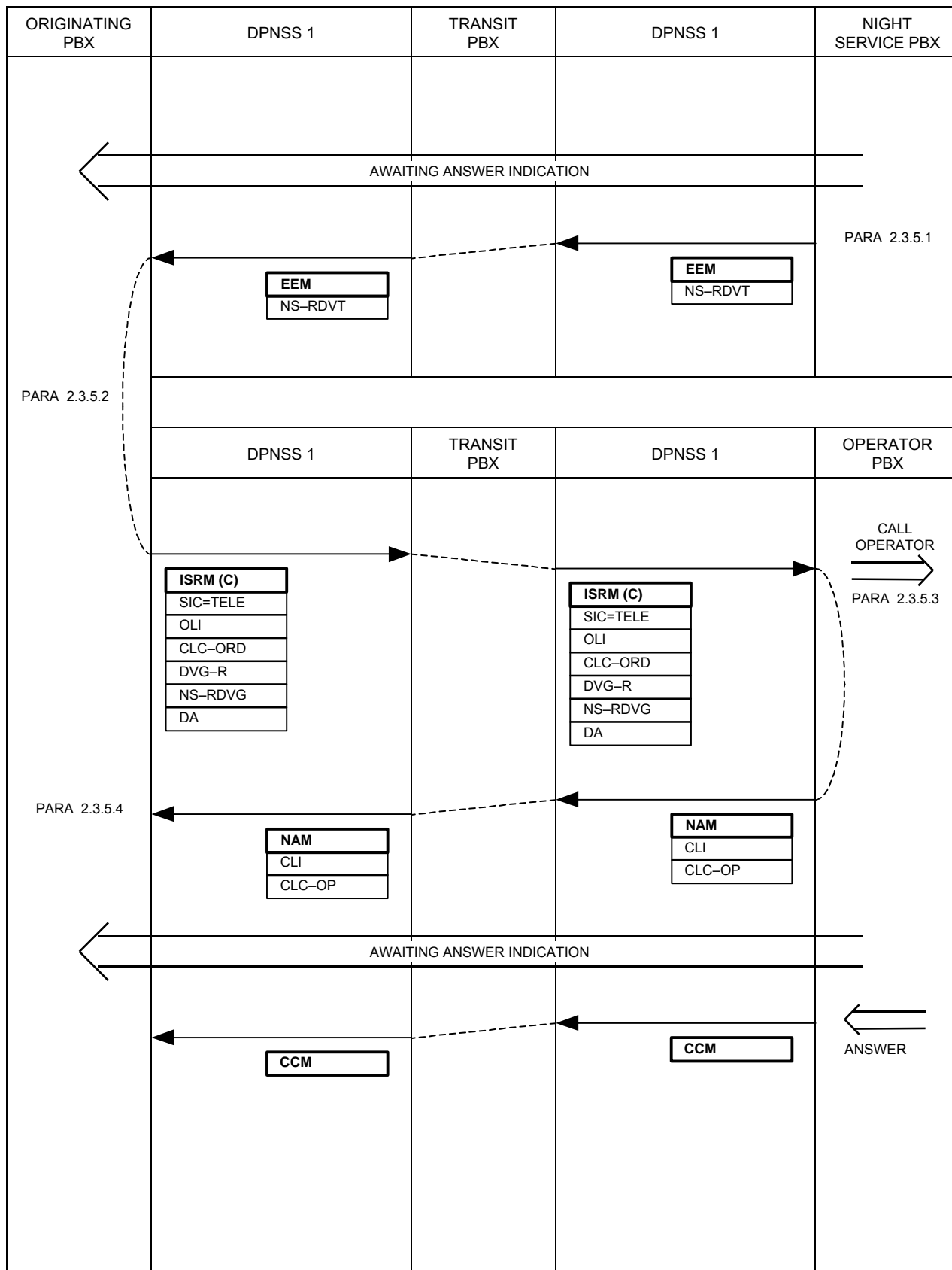

2.3.5.1 When Night Mode is deactivated, there may be calls which have been diverted to night service points while Night Mode was active and are still awaiting answer. If the Night Service Notification sequence (paragraph 2.3.1) is used to notify a night service point PBX that Night Mode has been deactivated, then any calls which have been diverted from the operator group concerned and are still awaiting answer at night service points may be rediverted back to the operator. A call will be eligible for rediversion only if the operator address from which it was diverted, as received in String NS-DVG in the ISRM, matches the operator address for which Night Mode has been deactivated.

To redivert a call, the Night Service PBX sends an EEM containing String Night Service Redivert (NS-RDVT), the Parameter of which holds the address to redivert to. The call continues to be presented to the night service point and a CCM will be sent if the call is answered.

The Night Service PBX expects to receive a CRM with Clearing Cause: CT when rediversion has taken place, and only then will it stop presenting the call to the night service point. This may be delayed if rediversion fails at the first attempt, owing to congestion, for example.

2.3.5.2 On receipt of an EEM containing NS-RDVT, the Originating PBX attempts to establish a new call to the operator address contained in the String. This sequence assumes that the destination of the new call is on a different route from the night service call or that the Originating PBX does not support Single-Channel Working. The Originating PBX selects a free outgoing channel and sends an ISRM containing Strings DVG-R and Night Service Rediverting (NS-RDVG) in addition to the normal ISRM contents.

2.3.5.3 On receipt of an ISRM containing DVG-R and NS-RDVG, the Operator PBX calls the operator, applies Awaiting Answer Indication and returns a NAM.

If Night Mode has been activated again, the call is rejected by sending a CRM with Clearing Cause: STU.

2.3.5.4 On receipt of a NAM, the Originating PBX clears the Night Service call by sending a CRM with Clearing Cause: CT.

On receipt of a CRM, indicating failure of the new call, the Originating PBX should leave the Night Service call established. Repeat attempts at rediversion may be made at suitable intervals, depending on the reason for failure. If Night Service has been activated again, the Clearing Cause will be Service Temporarily Unavailable (STU) and rediversion is not possible.

Receipt of a CCM indicates that the Night Service call has been answered and there is no longer any need to redivert. If a CCM arrives during an attempt at rediversion, the new call is cleared by sending a CRM with Clearing Cause: CT.

2.3.6 NIGHT SERVICE - REDIVERSION VIA THE SAME CHANNEL

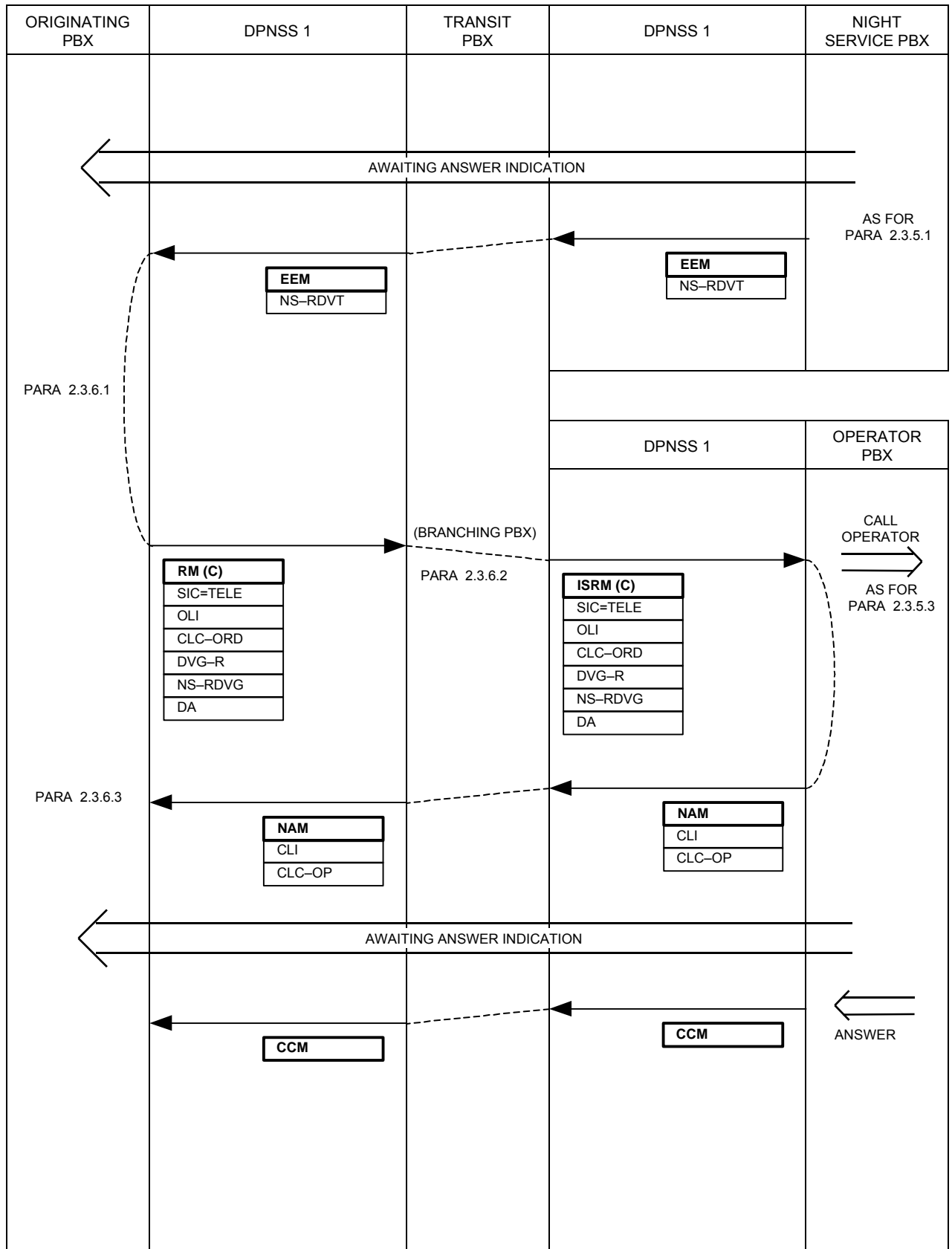

2.3.6.1 This sequence assumes that the destination of the new call is on the same route out of the Originating PBX as the Night Service call and that Single-Channel Working is supported. An RM(C) containing DVG-R and NS-RDVG is sent along the existing channel. The traffic channel is disconnected.

2.3.6.2 The behaviour of a Transit or Branching Transit PBX on receipt of an RM(C) containing DVG-R is described in SECTION 11, paragraph 2.3.10. The additional String NS-RDVG is simply passed on.

2.3.6.3 Receipt of a NAM indicates to the Originating PBX that rediversion is complete. The traffic channel is reconnected.

On receipt of an RRM, indicating failure of the new call, the Originating PBX reconnects the traffic channel. Repeat attempts at rediverting may be made at suitable intervals, depending on the reason for failure. If Night Service has been activated again and rediversion is not possible, the Clearing Cause should be STU.

Receipt of a CCM indicates that the night service point has answered and there is no longer any need to redivert. If a CCM is received during an attempt at rediverting, it is saved; if the attempt succeeds, the CCM is discarded, but if it fails the CCM is processed.

2.3.7 NIGHT SERVICE - REDIVERSION ON THE SAME PBX

If the operator group and the night service point are on the same PBX, rediversion can take place within the PBX. The Originating PBX is informed by means of an EEM containing Night Service Rediverted (NS-RDVD) and CLC-OP. The Parameter of NS-RDVD contains the identity of the operator group.

3 COMPLIANCE SHEETS FOR SUPPLEMENTARY SERVICE: NIGHT SERVICE

The Night Service Supplementary Service is an optional part of DPNSS 1 and its provision on a PBX is a matter for negotiation between a customer and his supplier (see FOREWORD in SECTION 0 of this specification). This Subsection may be used as an aid to those negotiations.

NOTE: Whilst the provision of this service is optional, if it is provided, compliance with certain features of the service becomes mandatory.

Compliance with the service is considered in terms of the function(s) to be performed by the PBX, i.e. Transit, End or Branching, and the extent to which the Operator PBX can apply the service.

The options available are given in TABLE 1. This table should be completed by a manufacturer to indicate PBX capability and by a purchaser to indicate PBX requirements.

TABLES 2 to 5 indicate the features that are required/provided at each PBX. The pre-printed "YES" indicates that the feature is a mandatory part of the service for that PBX function.

TABLE 1

PBX FUNCTION		APPLICABLE TABLE
PBX with operators, some of whom can initiate the service.		TABLE 3
PBX with extensions.		TABLE 2
Transit PBX.		TABLE 4
PBX with operators or extensions, some of which can be a Night Service Answer point.		TABLE 5

TABLE 2

COMPLIANCE TABLE FOR A PBX WITH EXTENSIONS IN A NETWORK THAT SUPPORTS NIGHT SERVICE		
SERVICE VARIANT		COMMENT
Able to accept a Night Service Notification call?	YES	
Able to respond correctly on receipt of a "Night Service - Divert" instruction from a called PBX?	YES	
Able to respond correctly on receipt of a "Night Service - Redivert" instruction from a Night Service answering point PBX?	YES	
Able to make a Night Service Diverted call via the same channel as the existing call?		
Able to make a Night Service Rediverted call via the same channel as the Night Service Diverted call?		

TABLE 3

COMPLIANCE TABLE FOR A PBX WITH OPERATORS THAT ARE ABLE TO INITIATE NIGHT SERVICE		
SERVICE VARIANT		COMMENT
Able to send Night Service Notification to other DPNSS 1 PBXs?		
Able to notify incoming calls that the PBX is on Night Service and that the call should be diverted to a specified address?	YES	
Able to act as a Branching PBX for Night Service Diverted calls that are received on the same channel as the original call?		
Able to accept Night Service Rediverted calls?	via a separate channel	YES
	via same channel as a Night Service Diverted call that is Transiting through the PBX	

TABLE 4

COMPLIANCE TABLE FOR A TRANSIT PBX IN A NETWORK THAT SUPPORTS NIGHT SERVICE			
SERVICE VARIANT			COMMENT
Able to act as a Transit PBX for diverted or rediverted calls received on the new channel?		YES	Inherent DPNSS 1 Capability
Able to act as a Transit for diverted or rediverted calls received on the same channel as the original call?	Non-Branching		
	Branching		

TABLE 5

COMPLIANCE TABLE FOR PBXs THAT ARE ABLE TO ACT AS NIGHT SERVICE ANSWER POINTS			
SERVICE VARIANT			COMMENT
Able to accept incoming Night Service Diverted Calls?	via a separate channel	YES	
	via the same channel as a call that is Transiting through the PBX		
Able to notify incoming Night Service Diverted calls that Night Service has been deactivated and that the call should be rediverted to the original operator?		YES	
Able to act as a Branching PBX for Rediverted calls that are received on the same channel as the Night Service Diverted Call?			
Able to Redivert to an operator on the same PBX?		YES	

DIGITAL PRIVATE NETWORK SIGNALLING SYSTEM NO 1 (DPNSS 1)

SECTION 26 - SUPPLEMENTARY SERVICE: CENTRALISED OPERATOR

CONTENTS

1	GENERAL	Page 2
2	CENTRALISED OPERATOR WITHIN DPNSS 1	Page 3
	2.1 DEFINITION.....	Page 3
	2.2 DESCRIPTION.....	Page 3
	2.3 OUTLINE OF OPERATION.....	Page 4
3	SUPPLEMENTARY SERVICES REQUIRED TO SUPPORT CENTRALISED OPERATORS	Page 6
	3.1 GENERAL.....	Page 6
	3.2 THREE-PARTY SERVICE (SECTION 13).....	Page 6
	3.3 CALL OFFER SERVICE (SECTION 14).....	Page 6
	3.4 REDIRECTION SERVICE (SECTION 22).....	Page 7
	3.5 EXECUTIVE INTRUSION SERVICE (SECTION 10).....	Page 7
	3.6 ROUTE OPTIMISATION SERVICE (SECTION 19).....	Page 8
	3.7 NIGHT SERVICE (SECTION 25).....	Page 8
	3.8 EXTENSION STATUS SERVICE (SECTION 20).....	Page 8
	3.9 CONTROLLED DIVERSION SERVICE (SECTION 21).....	Page 8
	3.10 SERIES CALL (SECTION 23).....	Page 8
	3.11 THREE-PARTY TAKEOVER (SECTION 24).....	Page 8
	3.12 HOLD SERVICE (SECTION 12).....	Page 9
4	COMPLIANCE	Page 10

HISTORY

Issue 1 - September 1984
Issue 2 - March 1986
Issue 3 - December 1989

Issue 4 - March 2001 - Specification renamed as DPNSS[188]

1 GENERAL

1.1 This Section details the signalling requirements of DPNSS 1 for the Centralised Operator Supplementary Service.

1.2 Subsection 2 details the service within DPNSS 1.

1.3 Subsection 3 lists the various other Supplementary Services needed to support centralised operators and describes how these services are used where operators are involved.

1.4 Subsection 4 shows the Compliance.

2 CENTRALISED OPERATOR SERVICE WITHIN DPNSS 1

2.1 DEFINITION

The Centralised Operator Service allows operators to assist with the connection of calls, without the need to provide and staff operator positions at every PBX in the DPNSS 1 network.

2.2 DESCRIPTION

A caller requiring operator assistance may dial an appropriate code and be routed to an operator position. After answering the call and determining the caller's requirements, the operator may make an enquiry call to the required destination and then transfer the caller.

Certain extensions may be automatically connected to an operator each time call origination is attempted. Normally, calls are routed to a group of operator positions, to be answered by any operator who is free. When all operators in a group are busy, further calls are queued. Alternatively, it may be possible to call a specific operator position; when that position is busy, further calls to that position are queued.

With DPNSS 1, there is no need to provide operator positions on every PBX of the network. Instead, operators can be centralised on a few PBXs, each of which provides an operator service for a number of PBXs in the area. The traditional main-satellite configuration is an example. In the extreme, a single PBX may provide an operator service for an entire network.

This service does not permit an operator group to be spread across two or more PBXs; all positions in an operator group must be on the same PBX.

A call requiring operator assistance is routed from the Originating (or Gateway) PBX to the Operator PBX. If necessary, it is queued at the operator PBX until a position becomes free.

Having answered an assistance call, an operator will normally establish a second (enquiry) call to the required destination, which may be on the operator PBX, the caller's PBX or a third PBX. The caller may then be connected to the called party (transfer).

An operator may also originate a call. When the call has been answered, the operator may make an enquiry call and transfer the two called parties together. This procedure is used when the operator is providing a delayed (as opposed to immediate) service and has to call back the party who has requested the service either before or after calling the wanted party. An operator may make a call to another operator.

2.3 OUTLINE OF OPERATION

Normal signalling procedures for the Simple Call and Supplementary Services apply, except that Calling/Called Line Category Operator (CLC-OP) is used to denote an operator instead of CLC-ORD. A PBX which receives CLC-OP may use it for any of the following purposes:

- Indicating to the local party that the call is from or to an operator,
- Granting the operator certain privileges or denying the local party certain privileges,
- Call logging.

NOTE: Most operator consoles are capable of displaying various information about calling and called extensions, eg Class Of Service details. The information displayed varies considerably between different manufacturers. DPNSS 1 does not currently provide a standard means of passing this information across a network, although the problem is receiving further study. In the meantime, particular requirements can be satisfied using the Non-Specified Information Service (SECTION 15).

2.3.1 Calls to an Operator

Each operator group has a full network address which, when used as the Destination Address in an ISRM, will cause routing through the network to the group. Specific operator positions may also have network addresses. A caller may dial the full network address of a group or specific position. Alternatively, the Originating PBX may supply the full network address when a line is seized or a special code is dialled.

The Terminating PBX will determine from the Destination Address that an operator group or specific position is required. The call will be queued or presented to the operator(s). The NAM will contain CLC-OP and CLI, representing the group or specific position to which the call has been routed. If, on answer, more specific information about the answering operator is available, a CLI identifying the answering operator position may be included in the CCM.

Although a call to an operator group or specific position can be rejected because of certain failure conditions (eg congestion), busy will not be encountered. Clearing Cause: Service Temporarily Unavailable (STU) is used if the queue is full.

2.3.2 Calls From An Operator

The ISRM contains CLC-OP. The CLI String identifies the operator position.

Whenever a call from an Operator is cleared back using a CRM containing the Clearing Cause: BY, the CRM must also contain a Service Information (SERV) String, if Call Offer and/or Executive Intrusion is/are known not to be available.

3 SUPPLEMENTARY SERVICES REQUIRED TO SUPPORT CENTRALISED OPERATORS

3.1 GENERAL

If operator positions are provided on every PBX of a DPNSS 1 network, operators will normally be required to assist in the connection of calls to extensions on their own PBXs. A caller on one PBX requiring assistance in connecting to an extension on a second PBX will normally call an operator on the second PBX using the signalling procedures defined in Subsection 2. It is possible for most of the Supplementary Services which an operator may need to use in setting up a connection to a local extension to be provided within the Operator PBX without the use of DPNSS 1 Supplementary Services.

Where operators are centralised, with operators on one PBX providing a service for a number of PBXs, certain DPNSS 1 Supplementary Services become necessary or desirable. These are discussed below.

3.2 THREE-PARTY SERVICE (SECTION 13)

All PBXs in the network must support Three-Party Service and use the procedures of that service when extensions or operators make enquiry calls and perform subsequent actions such as transfer. This ensures that all PBXs are kept updated with details of distant parties.

It may be desirable that the Operator PBX and other PBXs for which the operators are providing a service support Single-Channel Working. This prevents the possibility of an operator being unable to transfer a caller to another extension on the caller's PBX because of congestion on the route to the Operator PBX. However, this situation should arise only if routes are under equipped or operator positions are understaffed (causing queued calls to occupy channels).

3.3 CALL OFFER SUPPLEMENTARY SERVICE (SECTION 14)

An operator must have the facility to offer an incoming call to a busy extension (Camp On). This is achieved by using the Call Offer Service in conjunction with the Three-Party Service. When the operator requests Camp On, the Call Offer Procedure is used to establish a Call Offer call from the operator to the wanted extension. If this is successful, the Three-Party transfer procedure is used to transfer the calling party "on offer" to the wanted extension. All PBXs for which the Operator PBX provides a service must be capable of accepting a Call Offer Request.

3.4 REDIRECTION SUPPLEMENTARY SERVICE (SECTION 22)

All PBXs in the DPNSS 1 network must support the Redirection Service to the extent of being able to redirect back to the operator a call which has been transferred by an operator to an extension which has not answered and fails to answer within a certain time. This includes calls which have been transferred on offer to a busy extension and fail to progress within a certain time.

The PBX at the other end of a call to or from an operator may receive an EEM containing TRFD, indicating that the operator has transferred. If the subsequent EEM containing the other party's CLI and CLC also contains either SOD-F (indicating awaiting answer) or CW (indicating waiting on busy), a configurable timeout shall be started. The timeout shall be cancelled on receipt of a CCM. If the timeout was started as a result of CW, it shall be restarted if an EEM containing SOD-F is received. If the timeout expires, Redirection procedures shall be used to establish a call back to the operator, using the operator CLI as the Destination Address. The Operator PBX may use the received RDG String to give a special indication to the operator or assign a different priority to the call. If the Destination Address identifies a specific position which is now unattended, the Operator PBX should attempt to route the call to an alternative position.

The Redirection Service may also be used to redirect certain other types of call to the operator in the event of failure or no reply.

The Single-Channel Working option of the Redirection Service may be used to advantage but is not essential.

3.5 EXECUTIVE INTRUSION SUPPLEMENTARY SERVICE (SECTION 10)

The ability to intrude on a busy extension is an essential part of an operator service. The Executive Intrusion Service in DPNSS 1 can be used to permit an operator to intrude on a busy extension on a different PBX. Some designs of operator console may require the use of Executive Intrusion with Prior Validation so that the operator can be given an indication of whether intrusion is possible when a busy extension is encountered.

All PBXs for which the Operator PBX provides a service must be capable of accepting Intrusion Requests, both with and without Prior Validation. All PBXs in the network must be capable of responding to an IPL request.

3.6 ROUTE OPTIMISATION SERVICE (SECTION 19)

The Route Optimisation Service may be required in some networks for optimising calls after transfer by the operator.

The formation of "trombones" is prevented by use of the Single-Channel Working option of Three-Party Service. If that option is not available, it is strongly recommended that Route Optimisation is provided at all PBXs in the network.

Where the Single-Channel Working option of Three-Party Service is available, Route Optimisation can still be used to advantage in networks where alternative DPNSS 1 routes are available.

The Single-Channel Working option of the Route Optimisation Service may be used to advantage but is not essential.

3.7 NIGHT SERVICE (SECTION 25)

Where a night service point is provided on the Operator PBX for use by all types of caller, there may not be a need for the DPNSS 1 Night Service. However, the Service is essential where more sophisticated night service arrangements are required, eg local night-answering points.

3.8 EXTENSION STATUS SERVICE (SECTION 20)

The Extension Status Service can be used to give operators the capability of determining the status of an extension without causing it to be rung.

3.9 CONTROLLED DIVERSION SERVICE (SECTION 21)

Where the Diversion Service (SECTION 11) is used, the Controlled Diversion Service can also be used to advantage to allow operators to exercise control over any diversions encountered when establishing calls.

3.10 SERIES CALL (SECTION 23)

The Series Call Service can be used to allow operators to give series call capability to callers from other PBXs.

3.11 THREE-PARTY TAKEOVER (SECTION 24)

The Three-Party Takeover Service can be used to allow operators to take control of a three-party situation after answering an enquiry call from an extension on another PBX (the extension having a third party on hold).

3.12 HOLD SERVICE (SECTION 12)

The Hold Service, if provided, should be used as follows:

- The Operator PBX should reject any EEM containing HOLD-REQ from any party connected to an operator.
- A PBX should avoid sending an EEM containing HOLD-REQ when the distant party is an operator. Hold requests from extensions should be rejected locally.
- It is not necessary to use the procedures of the Hold Service when an operator places a party on hold in order to make an enquiry call. Transfer will normally occur within a few seconds and there is little point in supplying a holding indication (eg music) to the held party for such a short duration.
- If the operator places a party on hold for another reason, eg to attend to another call or await a response to paging, the procedures of the Hold Service should be used.

4 COMPLIANCE SHEET FOR SUPPLEMENTARY SERVICE: CENTRALISED OPERATOR

The Centralised Operator Supplementary Service is an optional part of DPNSS 1 and its provision on a PBX is a matter for negotiation between a customer and his supplier (see FOREWORD in SECTION 0 of this specification). This Subsection may be used as an aid to those negotiations.

NOTE: Whilst the provision of this service is optional, if it is provided, compliance with certain features of the service becomes mandatory.

Compliance with the service is considered in terms of the function(s) to be performed by the PBX, ie Transit, End or Branching, and whether the operator positions are situated on the PBX.

The options available are given in TABLE 1. This table should be completed by a manufacturer to indicate PBX capability and by a purchaser to indicate PBX requirements.

TABLES 2 to 4 indicate the features that are required/provided at each PBX. The pre-printed "YES" indicates that the feature is a mandatory part of the service for that PBX function.

TABLE 1

PBX FUNCTION		APPLICABLE TABLE
PBX with operator positions		TABLE 3
PBX with extensions		TABLE 2
Transit PBX		TABLE 4

TABLE 2

COMPLIANCE TABLE FOR A PBX WITH EXTENSIONS IN A NETWORK THAT SUPPORTS CENTRALISED OPERATOR		
SERVICE VARIANT		COMMENT
Able to support the Three-Party Service in Accordance with TABLE 2 of the Compliance for SECTION 13 of this specification?	YES	
Able to support Call Offer in accordance with TABLE 2 of the Compliance for SECTION 14 of this specification?	YES	
Able to support the Redirection Service in Accordance with TABLE 3 of the Compliance for SECTION 22 of this specification?	YES	
Able to support Executive Intrusion in Accordance with TABLE 2 of the Compliance for SECTION 10 of this specification?	YES	
Able to send Service Information when clearing back a call owing to a busy resource being encountered?	YES	
Able to support Route Optimisation in Accordance with TABLES 2 & 3 of the Compliance for SECTION 19 in this specification?		
Able to support Night Service in accordance with TABLE 2 of the Compliance for SECTION 25 of this specification (TABLE 5 of SECTION 25 should be met if an extension can act as a night service answer point)?		
Able to support Extension-Status Service in Accordance with TABLE 2 of the Compliance for SECTION 20 of this specification?		
Able to support Controlled Diversion in Accordance with TABLE 2 of the Compliance for SECTION 21 of this specification?		
Able to support Series Call Service in Accordance with TABLE 2 of the Compliance for SECTION 23 of this specification?		
Able to support Three-Party Takeover in Accordance with TABLE 2 of the Compliance for SECTION 24 of this specification?		
Able to support the Hold Service in Accordance with TABLE 2 of the Compliance for SECTION 12 of this specification?		

TABLE 3

COMPLIANCE TABLE FOR PBXs WITH OPERATORS IN A NETWORK THAT SUPPORTS CENTRALISED OPERATOR		
SERVICE VARIANT		COMMENT
Able to provide additional displays, etc?		List additional capabilities
Able to include CLC-OP in all calls that are Originated and received?	YES	
Able to support the Three-Party Service in Accordance with TABLE 4 of the Compliance for SECTION 13 of this specification?	YES	
Able to support Call Offer in accordance with TABLE 3 of the Compliance for SECTION 14 of this specification?	YES	
Able to support the Redirection Service in Accordance with TABLE 2 of the Compliance for SECTION 22 of this specification?	YES	
Able to support Executive Intrusion in Accordance with TABLE 3 of the Compliance for SECTION 10 of this specification?	YES	
Able to support Night Service in accordance with TABLE 3 of the Compliance for SECTION 25 of this specification?		
Able to support Extension-Status Service in accordance with TABLE 3 of the Compliance for SECTION 20 of this specification?		
Able to support Controlled Diversion in Accordance with TABLE 3 of the Compliance for SECTION 21 of this specification?		
Able to support Series Call service in accordance with TABLE 3 of the Compliance for SECTION 23 of this specification?		
Able to support Three-Party Takeover in accordance with TABLE 3 of the Compliance for SECTION 24 of this specification?		
Able to support the Hold Service?		

TABLE 4

COMPLIANCE TABLE FOR A TRANSIT PBX IN A NETWORK THAT SUPPORTS CENTRALISED OPERATOR		
SERVICE VARIANT		COMMENT
Able to support Call Offer in accordance with TABLE 4 of the Compliance for SECTION 14 of this specification?	YES	
Able to support the Three-Party Service in accordance with TABLE 6 of the Compliance for SECTION 13 of this specification?	YES	
Able to support the Redirection Service in Accordance with TABLE 4 of the Compliance for SECTION 22 of this specification?	YES	
Able to support Executive Intrusion in Accordance with TABLE 4 of the Compliance for SECTION 10 of this specification?	YES	
Able to support Route Optimisation in Accordance with TABLE 4 of the Compliance for SECTION 19 of this specification?		
Able to support Night Service in accordance with TABLE 4 of the Compliance for SECTION 25 of this specification?		
Able to support Extension-Status Service in Accordance with TABLE 4 of the Compliance for SECTION 20 of this specification?		
Able to support Controlled Diversion in Accordance with TABLE 4 of the Compliance for SECTION 21 of this specification?		
Able to support Series Call in accordance with TABLE 4 of the Compliance for SECTION 23 of this specification?		
Able to support Three-Party Takeover in accordance with TABLE 4 of the Compliance for SECTION 24 of this specification?		
Able to support the Hold service in accordance with TABLE 4 of the Compliance for SECTION 12 of this specification?		

DIGITAL PRIVATE NETWORK SIGNALLING SYSTEM NO 1 (DPNSS 1)

SECTION 27 - SUPPLEMENTARY SERVICE: TRAFFIC-CHANNEL MAINTENANCE

CONTENTS

1	GENERAL	Page 2
2	TRAFFIC-CHANNEL MAINTENANCE WITHIN DPNSS 1	Page 3
	2.1 DEFINITION.....	Page 3
	2.2 DESCRIPTION.....	Page 3
	2.3 RELATIONSHIP BETWEEN FUNCTIONS.....	Page 3
	2.4 SCOPE OF SERVICE.....	Page 4
	2.5 BACK-BUSY OF A CHANNEL.....	Page 4
	2.6 SAME-CHANNEL LOOP-BACK.....	Page 12
	2.7 SEPARATE-CHANNEL LOOP-BACK.....	Page 19
	2.8 NON-LOOPED-BACK TEST.....	Page 20
	2.9 TRAFFIC-CHANNEL STATUS.....	Page 28
	2.10 INTERACTION OF FUNCTIONS.....	Page 31
3	COMPLIANCE	Page 34

HISTORY

Issue 1 - March 1986

Issue 2 - December 1989

Issue 3 - March 2001 - Specification renamed as DPNSS[188]

1 GENERAL

- 1.1** This Section details the signalling requirements of DPNSS 1 for the Traffic-Channel Maintenance Supplementary Service.
- 1.2** Subsection 2 details the service within DPNSS 1.
- 1.3** Subsection 3 shows the Compliance.
- 1.4** The description is given in the form of Message Sequence Diagrams (MSDs) followed by explanatory text.
- 1.5** The text is referenced from MSDs at appropriate points in the sequences.
- 1.6** Message contents for successful actions are shown in MSDs. Messages and their contents for alternative sequences (eg for unsuccessful actions) are detailed in the text.
- 1.7** Coding of the contents of messages is given in SECTION 4.

2 TRAFFIC-CHANNEL MAINTENANCE WITHIN DPNSS 1

2.1 DEFINITION

Traffic-channel maintenance provides a set of functions which may be used to maintain a traffic channel on a single DPNSS 1 link between a pair of adjacent PBXs. These functions may be used to check whether the traffic channel is performing correctly and also to stop the PBX at the other end of the link using it if it is found to be faulty.

2.2 DESCRIPTION

This service allows the PBX at one end of the channel to carry out a number of functions on the channel. For the purposes of this Section, the PBXs shall be identified as PBX A (the PBX requesting or initiating the function) and PBX B (the PBX being asked to carry out the function). The following functions are possible:

- PBX A may back-busy a traffic channel to instruct PBX B not to use it.
- PBX A may request PBX B to loop-back a traffic channel to itself so that transmission testing may be carried out.
- PBX A may request PBX B to loop-back a traffic channel to another channel so that transmission testing may be carried out.
- PBX A may request PBX B to participate in a testing sequence where one PBX is the sender of a test sequence and the other PBX is the verifier of that sequence.
- PBX A may request PBX B to send the status of a traffic channel to determine whether or not it may be used for traffic.

2.3 RELATIONSHIP BETWEEN FUNCTIONS

These functions may be used individually or in combination. There is no restriction on the way in which they are combined, but the following series of actions is recommended when PBX A suspects that a traffic channel is faulty. These tests may be carried out manually or automatically.

- 1 PBX A back-busies the traffic channel to ensure that it is not used for traffic.
- 2 PBX A carries out internal tests to ensure the integrity of its internal equipment.

- 3 If this is successful, PBX A is now proved to be fault-free as far as can be tested.
- 4 PBX A requests PBX B either to loop-back the traffic channel (to itself or to another channel) or to participate in a non-looped-back test on the traffic channel. Using one of these mechanisms, a test signal is transmitted and its receipt verified. If this test is successful, the problem (if any) is assumed to be within PBX B. If this test fails, the problem is either within the traffic channel itself or in the part of PBX B used to perform the test.

2.4 SCOPE OF SERVICE

This service is of most benefit where some or all of the traffic channels use a different physical path to the signalling channel.

The benefit of using some facilities of this service for a 2 Mbit/s point-to-point connection may be limited. For example, the use of the loop-back facility to test transmission continuity is superfluous as continuity is checked implicitly by the signalling which is carried within the same multiplex (although it can enable a more accurate measurement to be made of the error rate on the channel). Other facilities, however, are equally applicable (eg back-busy or channel status may be used while carrying out internal testing).

For a description of how the functions interact, see paragraph 2.10.

Since Traffic Channel Maintenance is concerned only with communication with the PBX at the other end of a link, it should be possible for a PBX which supports Traffic Channel Maintenance to mark each link as supporting the service or not (based on the known capability of the PBX at the other end of the link). Given this information, a PBX should not attempt to use Link Maintenance Messages (LMMs) on a link where the service is not supported. On this basis there is nothing in the signalling definitions which follow covering the possibility of a Link Maintenance Message not being understood. (In general, the response to a LMM not understood by a PBX would be an Link by Link Reject Message (LLRM) with Rejection Cause: Message Not Understood (MNU), or a CRM with Clearing Cause: MNU).

2.5 BACK-BUSY OF A CHANNEL

Back-busy from PBX A to PBX B offers a means whereby selection of an outgoing traffic channel from PBX B may be inhibited. This does not affect the incoming traffic. Therefore, if PBX A has applied back-busy on a channel between PBX A and PBX B, calls are possible (ie an ISRM may be sent) from PBX A to PBX B, but not from PBX B to PBX A.

As back-busy affects only the selection of the traffic channel, a call in progress will not be affected when the back-busy condition is applied. If the action which caused the back-busy to be applied also requires that the call be released, this must be done separately by using the Simple Call clear-down protocols (SECTION 6).

A traffic channel may be back-busied in either direction, or may be back-busied in both directions at the same time.

This function may additionally be used for Virtual Channels. For simplicity, the text and MSDs describe its use only for Real Channels.

This facility is implemented using the following separate signal sequences:

- 2.5.1 Back-Busy Request
- 2.5.2 Call Received from Back-Busied Channel
- 2.5.3 Cancellation of Back-Busy

2.5.1 BACK-BUSY REQUEST

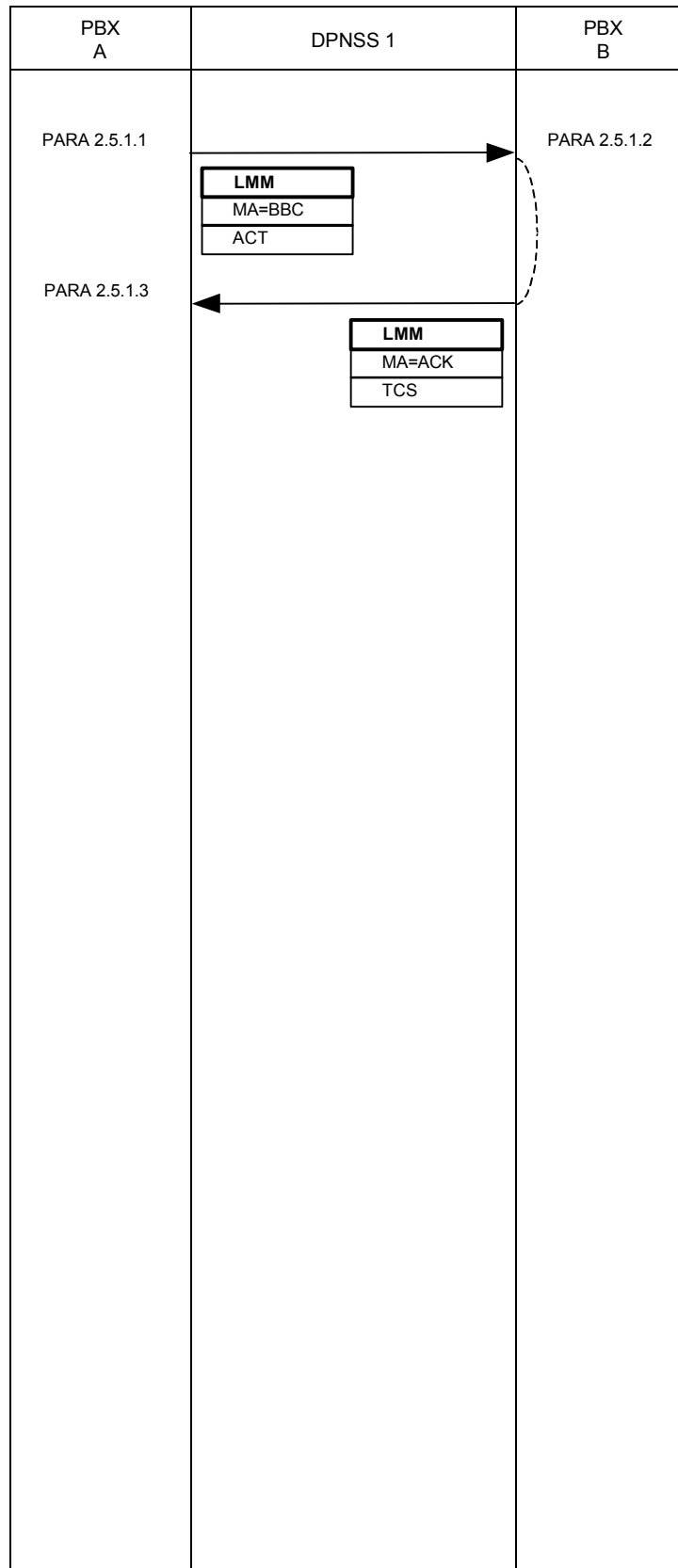

2.5.1.1 When PBX A wishes to inhibit traffic from a traffic channel, it sends a Link Maintenance Message (LMM) containing the Maintenance Action: Back Busy Control (BBC) and the String "Activate" (ACT) to indicate that back-busying is required.

If no response is received within 2 s (± 1 s) of sending the request, it shall be repeated. If this occurs a second time, it shall be treated as if the request had not been understood.

2.5.1.2 When the LMM, containing the Maintenance Action: BBC and the String ACT, is received, the traffic channel is back-busied. An LMM is returned with the Maintenance Action: Acknowledge (ACK) and the String Traffic Channel Status (TCS) with the Parameter "Back Busy By You" to acknowledge that the back-busy condition has been applied.

Once the traffic channel has been back-busied, it may not be used to originate calls from PBX B until the condition is removed.

Calls may still be received from PBX A.

If the traffic channel had already been back-busied, LMM is still returned containing the String TCS with the Parameter "Back Busy By You".

If the channel cannot be back-busied, an LMRM containing Clearing Cause: REJ and the String TCS is returned.

2.5.1.3 When the LMM with the Maintenance Action: ACK and String TCS (with the Parameter "Back Busy By You") is received, it is known that the traffic channel is back-busied and that calls should not be received.

If a Link Maintenance Reject Message (LMRM) is received (indicating that the request has not been carried out), calls may still be received.

See paragraph 2.5.2 for the action taken if a call is received on a back-busied traffic channel.

2.5.2 CALL RECEIVED FROM BACK-BUSIED CHANNEL

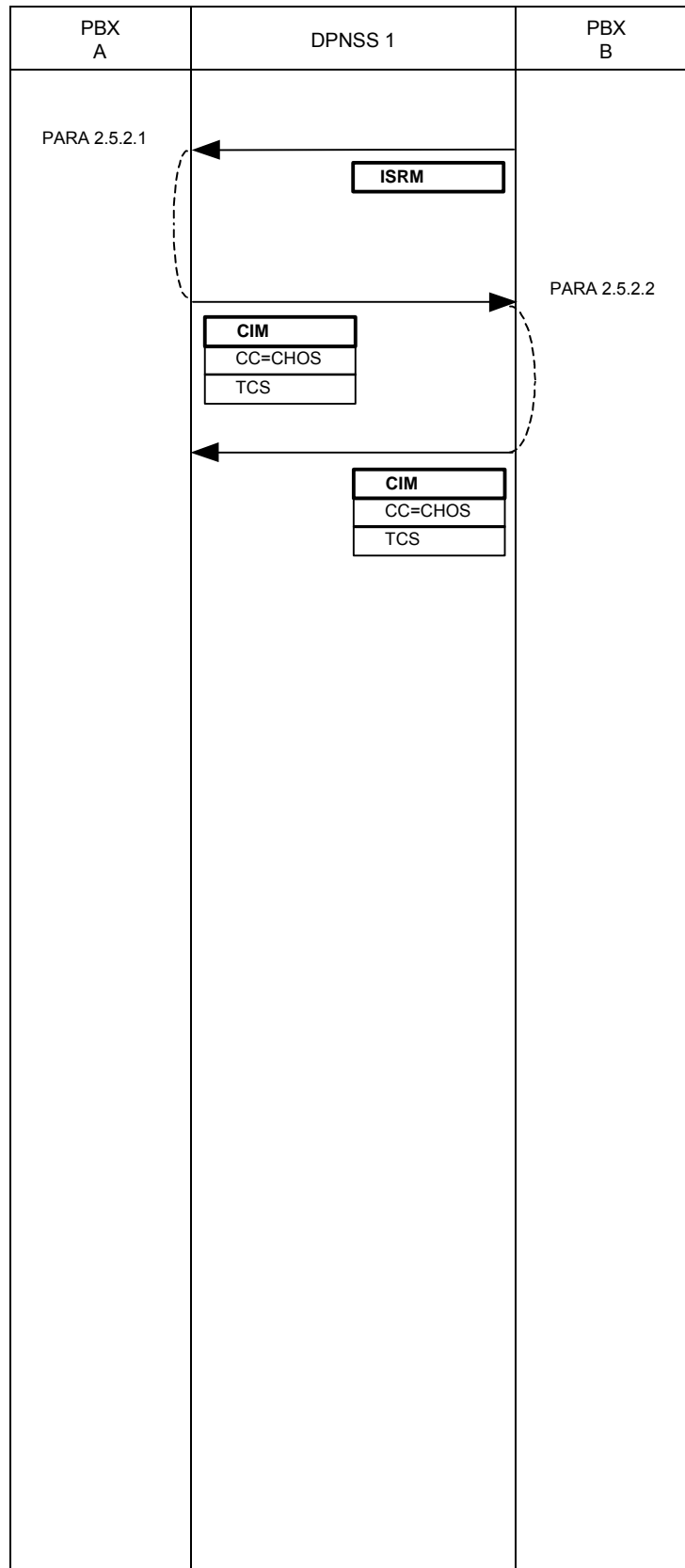

2.5.2.1 When an ISRM is received on a traffic channel which has been back-busied, the call shall be released. The Clearing Cause: Channel Out of Service (CHOS) shall be used in the CRM and the String TCS (with the Parameter "Back Busy By Me") shall be added to indicate that it is temporarily unavailable because it is back-busied.

2.5.2.2 On receipt of the CRM containing the Clearing Cause: CHOS and the String TCS, the call attempt shall be abandoned on that traffic channel. Another attempt may be made using another traffic channel.

Having returned the CIM, the "Back Busy By Me" indication received shall cause PBX B to apply a back-busied condition to the channel as if the Back-Busy protocol had just been completed.

2.5.3 CANCELLATION OF BACK-BUSY

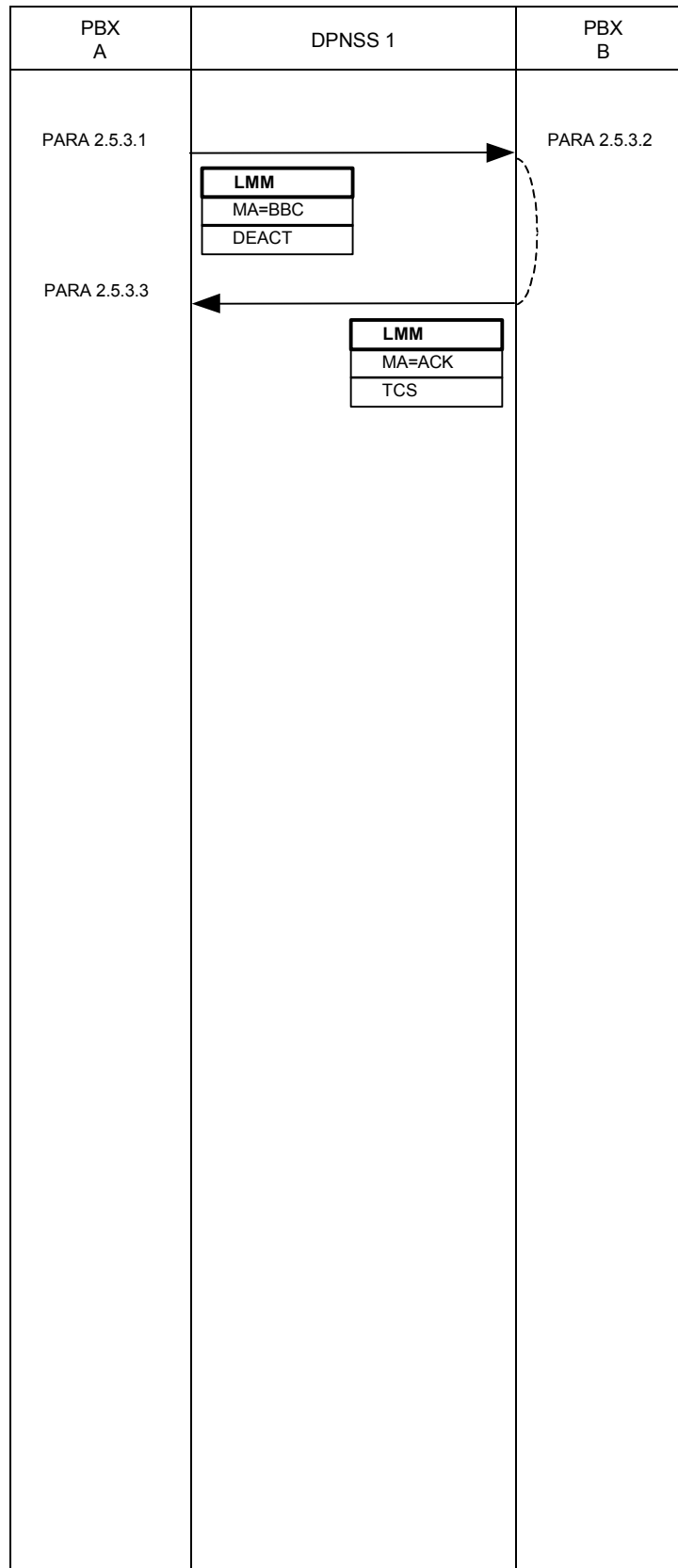

2.5.3.1 When the back-busy condition is to be removed, the same mechanism is used as for applying back-busy. An LMM containing the Maintenance Action: BBC and the String "Deactivate" (DEACT) is sent to indicate that back-busy is no longer required.

If no response is received within 2 s (± 1 s) of sending the request, it shall be repeated. If this occurs a second time, the request shall be abandoned and the traffic channel shall be treated as if the condition had been removed.

2.5.3.2 When the LMM is received containing the Maintenance Action: BBC and the String DEACT, the back-busied condition on the traffic channel shall be removed and an LMM shall be returned with the Maintenance Action: ACK to indicate this fact. The String TCS shall be included to indicate the current status of the traffic channel.

If the traffic channel was not back-busied, a Link Maintenance Reject Message (LMRM) shall be sent, containing the Clearing Cause: Facility Not Registered (FNR). The String TCS shall still be returned.

2.5.3.3 When an LMM with the Maintenance Action: ACK is received, it is known that the traffic channel is no longer back-busied and that calls may now be received.

If any other response is received, it should be assumed that the channel is now not back-busied, although the details of the response may be used for reporting purposes.

2.6 SAME-CHANNEL LOOP-BACK

Same-channel loop-back provides a means of instructing the PBX at the other end of the link (ie at an adjacent PBX) to connect the transmit and receive paths of the specified traffic channel. If the traffic channel is four-wire analogue, the normal loss/gain pad settings shall be used. If the channel is digital, no loss/gain pad shall be included. In this way, any signal sent on the traffic channel will be returned to the sender.

A loop is normally cancelled by the PBX requesting the loop-back. The other PBX may request that the loop be cancelled, or force its cancellation.

The purpose of this is to enable a PBX to test the integrity of the traffic channel between itself and the other PBX.

Owing to the fact that two-wire analogue traffic channels are not capable of supporting this, it shall not be used on that type of traffic channel. They shall use separate-channel loop-back.

Loop-back should be carried out as close as is practical to the line termination (ECMA reference point B4). In this way, the minimum amount of PBX hardware is involved. This ensures that the testing is carried out as far as is possible on the channel and not on the PBX equipment at either end.

A looped-back channel may not be used for traffic in either direction.

This facility is implemented using the following separate signal sequences:

- 2.6.1 Same-Channel Loop-Back Request
- 2.6.2 Cancellation of Loop-Back
- 2.6.3 Request of Loop-Back Cancellation

2.6.1 SAME-CHANNEL LOOP-BACK REQUEST

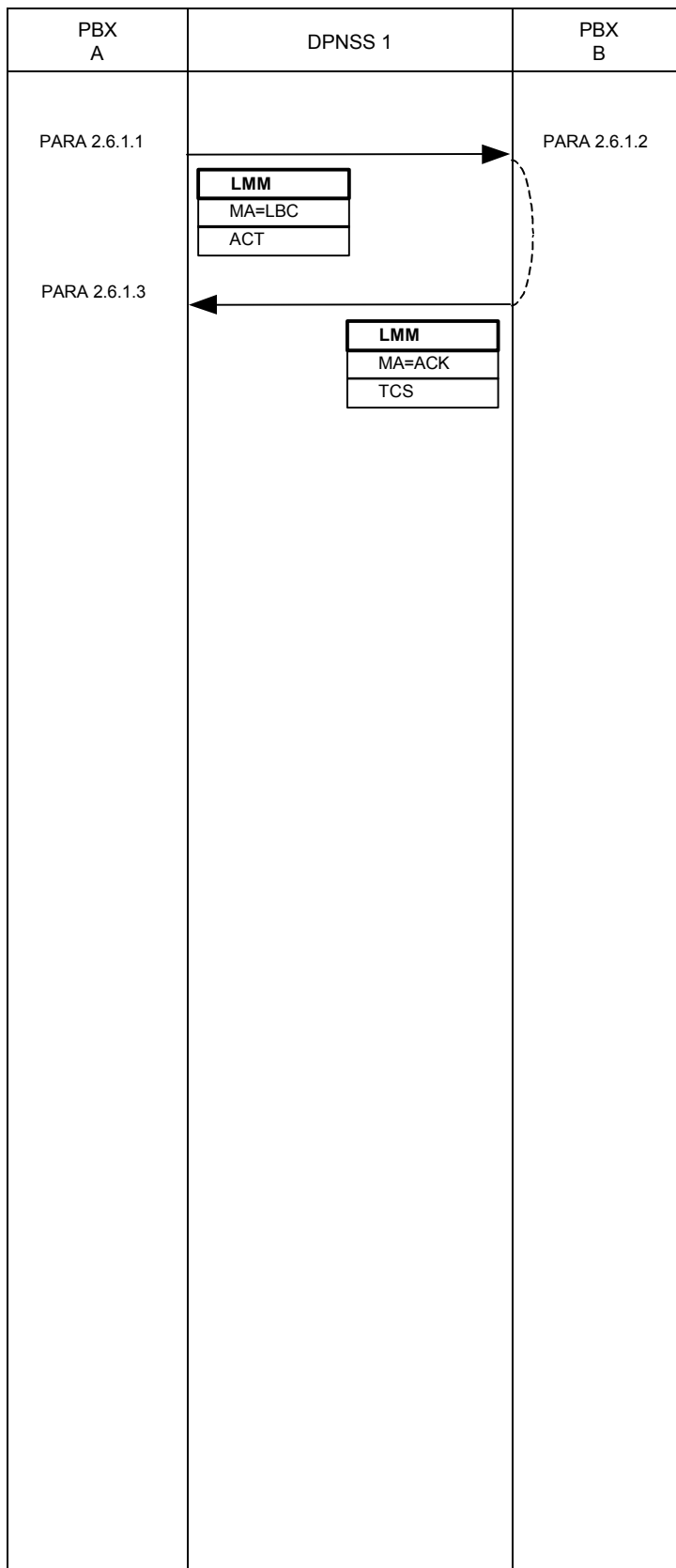

2.6.1.1 When PBX A wishes PBX B to loop a traffic channel back to itself (to enable testing to take place), it sends an LMM containing the Maintenance Action: Loop Back Control (LBC) and the String ACT, indicating that loop-back is required.

If no response is received within 2 s (± 1 s) of sending the request, it shall be repeated. If this occurs a second time, it shall be treated as if the request had not been understood.

2.6.1.2 When an LMM containing the Maintenance Action: LBC and the String ACT is recognised, if the traffic channel is busy, an LMRM containing the Clearing Cause: Busy (BY) shall be returned.

If same-channel loop-back is not supported, an LMRM containing the Clearing Cause: Reject (REJ) shall be returned.

If the traffic channel is idle, PBX B shall connect the transmit and receive paths and respond with an LMM containing the Maintenance Action: ACK and the String TCS (with the Parameter "Looped Back by Me") to indicate that the traffic channel has been looped back and is available for testing.

PBX B shall not use the channel for traffic.

Signalling shall not be looped back.

2.6.1.3 On receipt of an LMM containing the Maintenance Action: ACK and the String TCS (with the Parameter "Looped Back by Me"), the Requesting PBX may use the traffic channel for carrying out any transmission tests required.

If an LMRM is received, the attempt shall be abandoned.

2.6.2 CANCELLATION OF LOOP-BACK

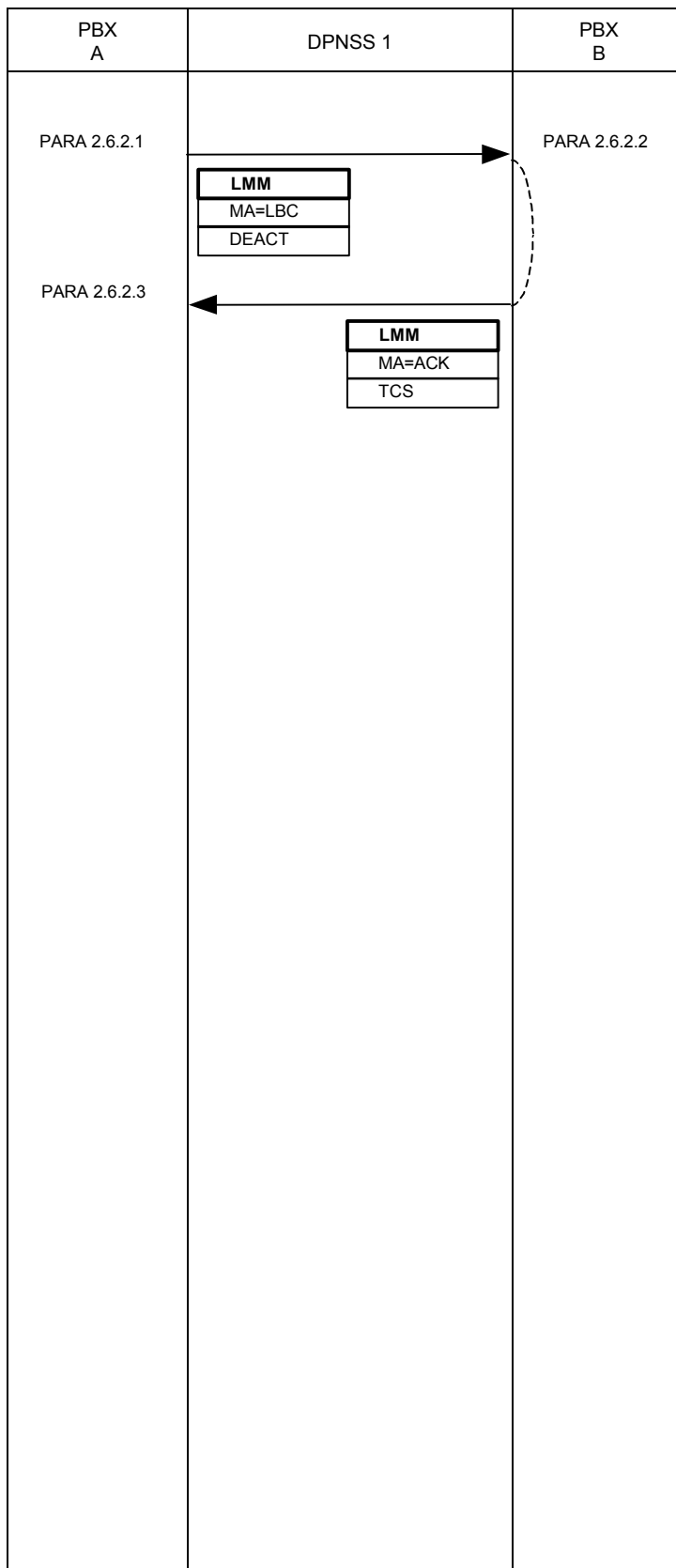

2.6.2.1 Loop-back would normally be cancelled only by the Requesting PBX (either when testing is complete or when it is abandoned). Cancellation while setting up the loop-back is not permitted until receipt of a response to the request.

Loop-back of the traffic channel shall be cancelled by PBX A sending an LMM containing the Maintenance Action: LBC and the String DEACT. Any test equipment used must be released before initiating the release sequence.

If no response is received within 2 s (± 1 s) of sending the request, it shall be repeated. If this occurs a second time, it shall be treated as if the request had been carried out.

2.6.2.2 On receipt of an LMM containing the Maintenance Action: LBC and the String DEACT, the path shall be disconnected and the cancellation protocol shall be completed by sending an LMM containing the Maintenance Action: ACK. The String TCS is also sent to indicate the current status of the traffic channel.

If the loop-back condition was not in force, an LMRM shall be sent containing the Clearing Cause: FNR. The String TCS shall still be returned.

The channel may then be used for traffic.

2.6.2.3 On receipt of an LMM containing the Maintenance Action: ACK, it is known that the loop-back condition has been removed and the traffic channel can be returned to normal use.

If any other response is received, it should be assumed that the channel is now not looped-back, although the details of the response may be used for reporting purposes.

2.6.3 REQUEST OF LOOP-BACK CANCELLATION

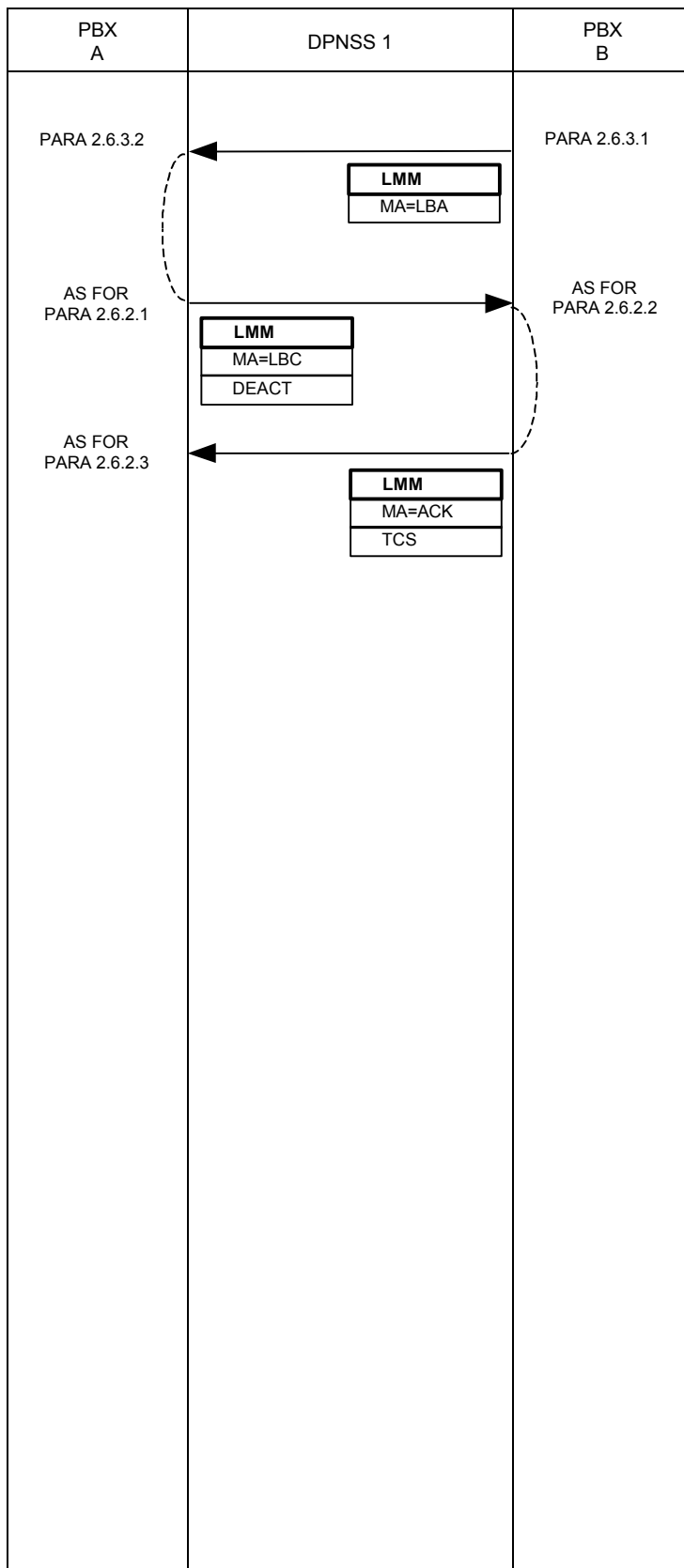

2.6.3.1 Loop-back would normally be cancelled only by the Requesting PBX (either when testing is complete or when it is abandoned), but it may be necessary for the Requested PBX to cancel the loop (eg if the line card is to be removed).

Cancellation of the loop-back shall be requested by PBX B sending an LMM containing the Maintenance Action: Loop Back Abort (LBA).

If no response is received within 2 s (± 1 s) of sending the request, it shall be repeated. If this occurs a second time, it shall be treated as if the request had been carried out. An LMM shall be sent containing the Maintenance Action: ACK and the String TCS, indicating that the loop is no longer present.

If an LMRM containing the Clearing Cause: FNR is received, the request should be deemed to have succeeded and an LMM containing the Maintenance Action: ACK and the String TCS is returned as normal.

2.6.3.2 On receipt of the LMM containing the Maintenance Action: LBA, PBX A shall cancel the loop-back in the normal way (see paragraph 2.6.2).

If PBX A had already requested cancellation of the loop-back when the LMM containing the Maintenance Action: LBA was received, it shall be ignored.

If PBX A has no record of loop-back being active, an LMRM containing the Clearing Cause: FNR is returned; String TCS is also included.

2.7 SEPARATE-CHANNEL LOOP-BACK

Separate-Channel Loop-Back works in a similar way to Same-Channel Loop-Back. The traffic channel indicated at Level 2 shall be connected to the channel indicated within the request. If one or both of the channels are analogue, the normal loss/gain pad settings shall be used. If both of the channels are digital, no loss/gain pad shall be included.

Care must be taken with this form of loop-back for cases other than a direct point-to-point connection. The identity of the channels at the distant PBX may not be the same as those seen by the sending PBX.

Separate-Channel Loop-Back may be used on either analogue or digital traffic channels.

2.7.1 Separate-Channel Loop-Back Request

This is the same as for Same-Channel Loop-Back, (paragraph 2.6.1) with the following exceptions:

- 1 The String "Channel Identity" (CHID) shall be added to the Loop-Back Request, indicating the second channel to be used.
- 2 If either channel is in use, the rejection mechanism for Same-Channel Loop-Back shall be used with Clearing Cause: BY. If either channel cannot be used to support Separate-Channel Loop-Back (for example, if String CHID identifies the signalling channel or a channel with no associated Data Link Connection) the rejection mechanism for Same-Channel Loop-Back shall be used with Clearing Cause: SU.

2.7.2 Cancellation of Separate-Channel Loop-Back

This is the same as for Cancellation of Same-Channel Loop-Back (see paragraph 2.6.2).

2.7.3 Request of Loop-Back Cancellation

This is the same as for Request of Loop-Back Cancellation for Same-Channel (see paragraph 2.6.3).

2.8 NON-LOOPED-BACK TEST

Non-looped-back test provides a means of investigating the integrity of a traffic channel without employing a loop-back mechanism. Although it can be used in addition to or instead of a loop-back test under general conditions, it may be particularly useful in cases where the same-channel loop-back is not possible and there are insufficient traffic channels available to isolate a faulty channel using separate-channel loop-back.

A PBX requiring to test a traffic channel in this manner may act as receiver or sender of an agreed test pattern, with the result of the test being available to both PBXs.

In order to perform this test, the traffic channel in question must be idle in call-control terms and not looped-back in maintenance terms. The test may take place on a back-busied channel, although a PBX is at liberty to consider a back-busied channel as unavailable for non-looped-back testing.

The significance of the test result (as pass, fail or aborted) is PBX-dependent in that action on determining pass or fail may take the form of error logging, taking the channel out of service, or other such action. In addition, any action taken may be threshold-based in that a sequence of test results may be required before a PBX takes any action.

Each channel which can be tested must be allocated a default test. If a PBX is capable of performing more than one test on a particular channel, each test is given a test index specific to that channel which enables individual tests to be selected as required. For a given channel and test, the test sequence to be performed must be agreed between the suppliers of the PBXs connected by the channel in question.

Although any mutually agreed test pattern(s) may be used for conducting a given test, it is recommended that at least one standard test is supported. The following is a list of agreed standard tests which may be expanded in number in the future. The allocation of test indices to these tests or the use of any of them as defaults must still be agreed on a per-link basis between PBX suppliers of a particular network. In particular, the standard test number detailed below does not necessarily have to be used as the test index.

- 1 MF tone sequence "#159" conforming to the appropriate sections of BS 6305.

A channel under test shall not be used for traffic and shall be regarded as Out of Service.

This facility is implemented using the following signalling sequences:

- 2.8.1 Non-looped-back test as receiver.
- 2.8.2 Non-looped-back test as sender.

2.8.1 NON-LOOPED-BACK TEST AS RECEIVER

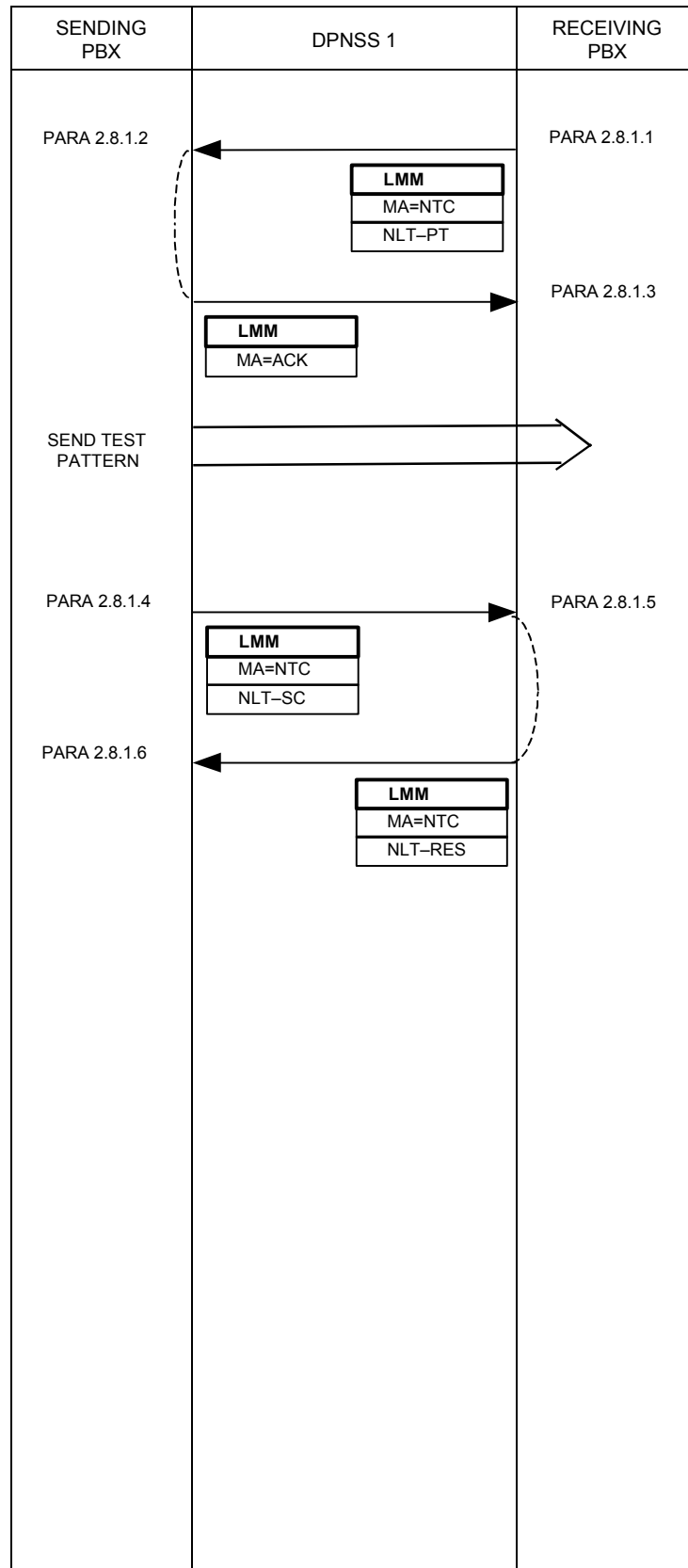

2.8.1.1 If a PBX wishes to initiate testing on an idle channel as the receiver (verifier) of the test sequence, an LMM containing the Maintenance Action: NTC and String NLT-PT shall be sent and the appropriate receiving equipment connected to the traffic channel. A particular test may be indicated by adding a Parameter to NLT-PT. No Parameter implies that a default test is to be performed.

2.8.1.2 On receipt of an LMM containing the Maintenance Action: NTC and String NLT-PT, sender equipment shall be attached to the traffic channel, an LMM containing the Maintenance Action: ACK returned and the appropriate test sequence sent in the traffic channel.

If, on receipt of NLT-PT, it is not possible to perform the test then an LMRM shall be returned instead; the Rejection Cause is dependent upon the reason for failure as follows:

- BY - Channel is not idle
- SNU - Test is not supported
- STU - Other reason (eg no currently available equipment).

2.8.1.3 Receipt of an LMM containing the Maintenance Action: ACK indicates that the test is proceeding. If, instead, an LMRM is received or no message is received within a suitable time period, the test shall be aborted locally.

NOTE: The receiving PBX must be ready to accept the test pattern as soon as NLT-PT has been sent, as the acknowledgement may be received on the signalling channel after the start of the test pattern has been received on the traffic channel.

At any time after the receipt of the LMM containing the Maintenance Action: ACK, the receiving PBX may abort the test by returning an LMM containing the Maintenance Action: NTC and String NLT-RES with a Parameter indicating test aborted.

2.8.1.4 When the sending sequence has been completed by the sending PBX, an LMM containing the Maintenance Action: NTC and the String NLT-SC shall be sent.

If, before indicating sending complete, an LMM containing the Maintenance Action: NTC and String NLT-RES is received, the test shall be aborted locally.

2.8.1.5 On receipt of an LMM containing the Maintenance Action: NTC and String NLT-SC, the expected test pattern shall be compared with the received test pattern and an LMM containing the Maintenance Action: NTC and String NLT-RES returned. The Parameter to the String represents the result of the test as pass or fail. As an option in the fail case, an LMM containing the Maintenance Action: NTC and String NLT-PT may be sent in place of NLT-RES to cause repetition of the test. Since the test to be performed is already identified, no Parameter need be added to NLT-PT.

If, after receipt of ACK, NLT-SC is not received within a suitable time period then the test shall be aborted locally and an LMM containing the Maintenance Action: NTC and String NLT-RES with a Parameter indicating test aborted shall be sent.

2.8.1.6 Having indicated that the sequence is complete by sending NLT-SC, the test result is awaited. This is indicated by receipt of an LMM containing the Maintenance Action: NTC and String NLT-RES, the result of the test being conveyed via the Parameter to NLT-RES. Alternatively, a retest may be indicated by receipt of an LMM containing the Maintenance Action: NTC and String NLT-PT, in which case the procedures from paragraph 2.8.1.2 apply. Any Parameter received with NLT-PT shall be ignored. If neither NLT-RES nor NLT-PT is received within a suitable time period, the test shall be aborted locally.

2.8.2 NON-LOOPED-BACK TEST AS SENDER

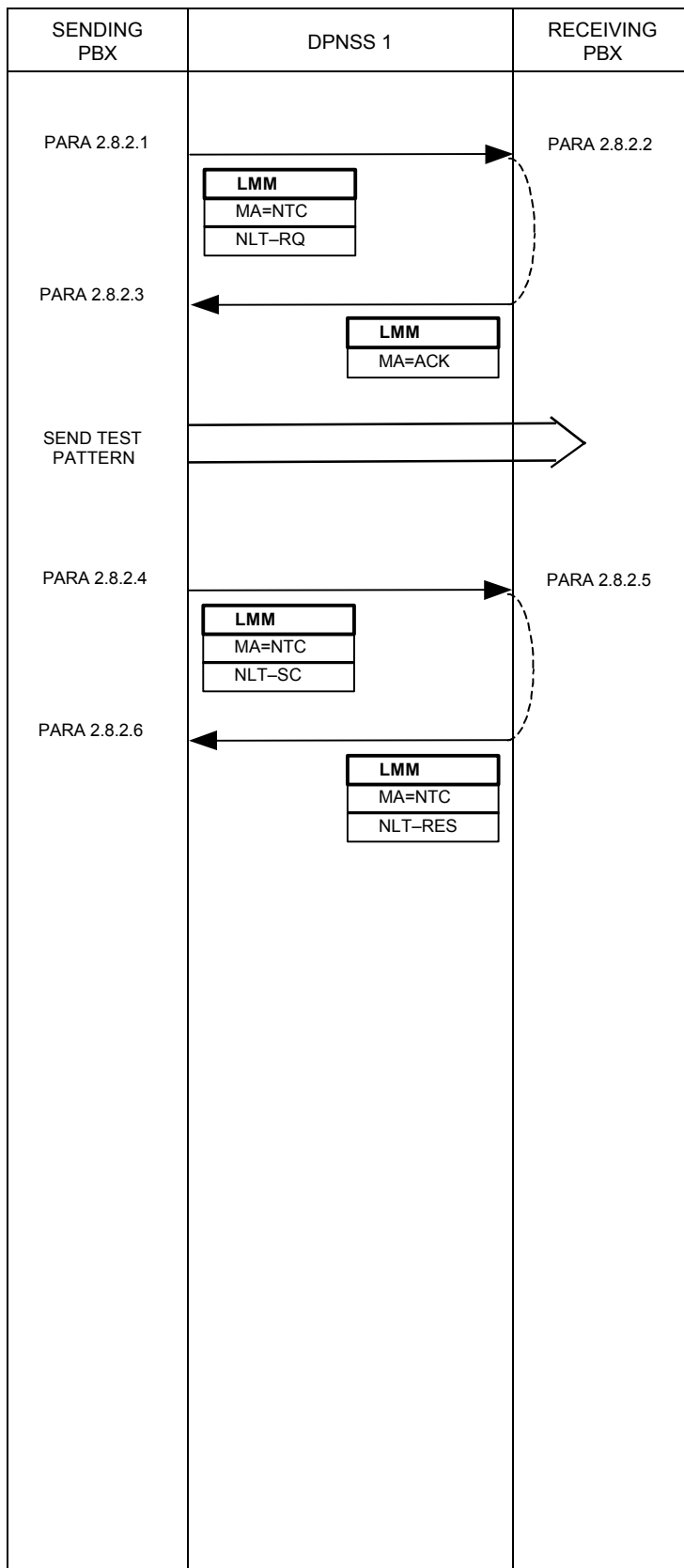

2.8.2.1 If a PBX wishes to initiate a test on an idle channel with the PBX at the other end of the channel as the receiver (verifier) of the test sequence, the necessary sending equipment shall be reserved and an LMM containing the Maintenance Action: NTC and the String NLT-RQ sent. A particular test may be indicated by adding a Parameter to NLT-RQ. No Parameter implies that a default test is to be performed.

2.8.2.2 On receipt of an LMM containing the Maintenance Action: NTC and the String NLT-RQ, an LMM containing the Maintenance Action: ACK shall be returned and appropriate receiving equipment connected to the channel.

If, on receipt of NLT-RQ, it is not possible to perform the test then an LMRM shall be returned instead; the Rejection Cause is dependent upon the reason for failure as follows:

- BY - Channel is not idle
- SNU - Test is not supported
- STU - Other reason (eg no currently available equipment).

At any time after returning the LMM containing the Maintenance Action: ACK, the receiving PBX may abort the test by returning an LMM containing the Maintenance Action: NTC and String NLT-RES with a Parameter indicating test aborted.

2.8.2.3 When an LMM containing the Maintenance Action: ACK is received, the test pattern shall be transmitted in the traffic channel. If, instead, an LMRM is received or no message is received within a suitable time period, the test shall be aborted locally.

2.8.2.4 When the sending sequence has been completed by the sending PBX, an LMM containing the Maintenance Action: NTC and the String NLT-SC shall be sent.

If, before indicating sending complete, an LMM containing the Maintenance Action: NTC and String NLT-RES is received, the test shall be aborted locally.

2.8.2.5 On receipt of an LMM containing the Maintenance Action: NTC and String NLT-SC, the expected test pattern shall be compared with the received test pattern and an LMM containing the Maintenance Action: NTC and String NLT-RES returned. The Parameter to the String represents the result of the test as pass or fail. As an option in the fail case, an LMM containing the Maintenance Action: NTC and String NLT-PT may be sent in place of NLT-RES to cause repetition of the test. Since the test to be performed is already identified, no Parameter need be added to NLT-PT.

If having sent ACK, NLT-SC is not received within a suitable time period then the test shall be aborted locally and an LMM containing the Maintenance Action: NTC and String NLT-RES with a Parameter indicating test aborted shall be sent.

2.8.2.6 Having indicated sequence complete by sending NLT-SC, the test result is awaited. This is indicated by receipt of an LMM containing the Maintenance Action: NTC and String NLT-RES, the result of the test being conveyed via the Parameter to NLT-RES. Alternatively, a retest may be indicated by receipt of an LMM containing the Maintenance Action: NTC and String NLT-PT, in which case the procedures from paragraph 2.8.1.2 apply. Any Parameter received with NLT-PT shall be ignored. If neither NLT-RES nor NLT-PT is received within a suitable time period, the test shall be aborted locally.

2.9 TRAFFIC-CHANNEL STATUS

A Traffic-Channel Status Request enables a PBX at one end of a link to find out the status of the specified traffic channel as seen from the other end.

This is used to enable a PBX, which for some reason has lost the knowledge of the traffic-channel status, to refresh its information.

Examples of why this may be done are:

- 1 PBX recovering after failure where information has been lost,
- 2 Man-machine command used when maintenance personnel think that the two PBXs are out of step,
- 3 Installation of a new PBX in the network.

This function may be used for either Real or Virtual Channels. For simplicity, the MSDs show its use only for Real Channels.

This facility is implemented using the following signalling sequence:

2.9.1 CHANNEL-STATUS REQUEST

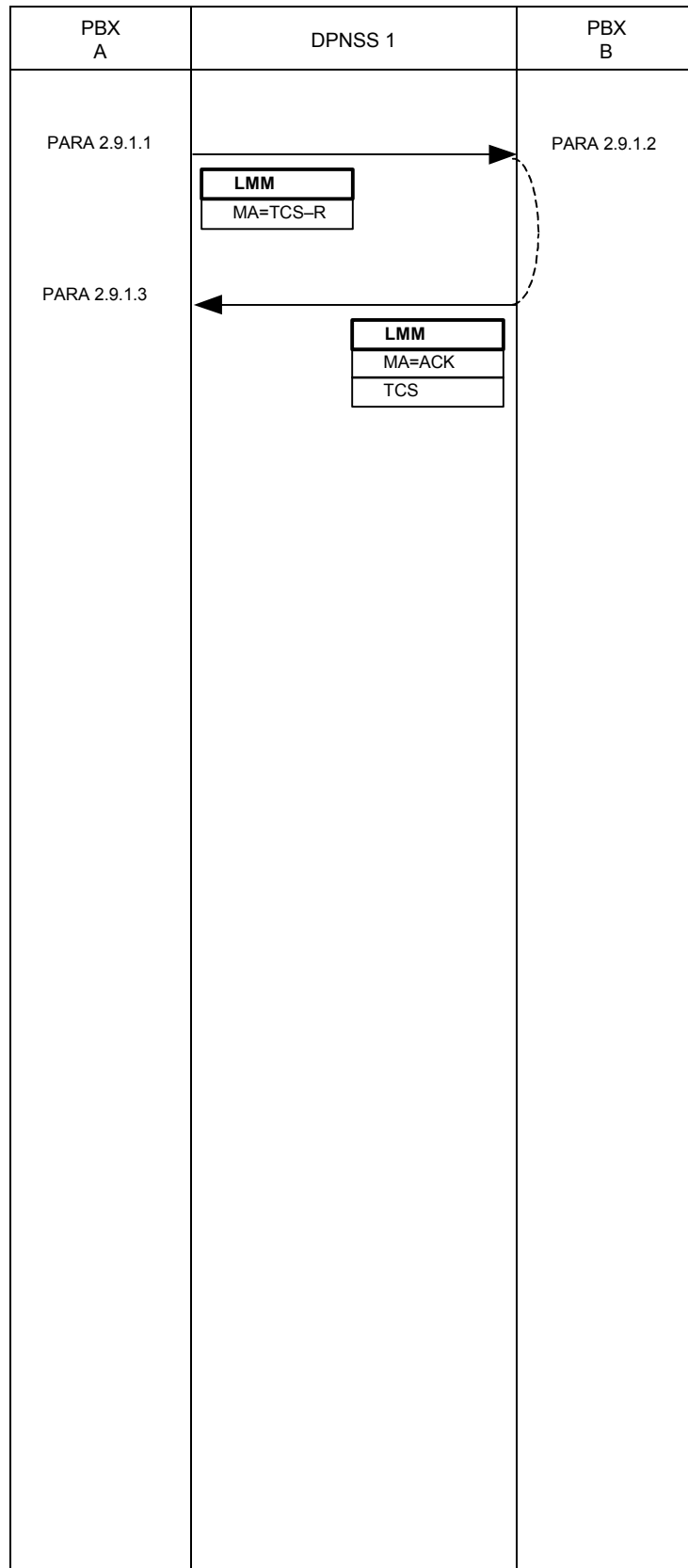

2.9.1.1 When PBX A wishes to determine the state of a traffic channel at PBX B, it sends an LMM containing the Maintenance Action: Traffic Channel Status Request (TCS-R) to indicate that the channel status is required.

If no response is received within 2 s (± 1 s) of sending the request it shall be repeated. If this occurs a second time, it shall be treated as if the request had not been understood.

2.9.1.2 When an LMM containing the Maintenance Action: TCS-R is recognised, the traffic-channel status shall be determined and an LMM shall be returned with the Maintenance Action: ACK and the String TCS to indicate the status of the traffic channel.

2.9.1.3 When an LMM with the Maintenance Action: ACK and the String TCS is received, the status may be used for whatever purpose it was required. In particular, if a discrepancy exists between the status returned and the status expected, the PBX may clear any call which is in progress on that channel. The PBX must, however, ensure that any apparent discrepancy has not been caused by simultaneous call establishment or clear-down. If a PBX does decide to clear a call because of a status discrepancy, it shall do so in the following manner:

if the state is indicated as free and a call exists at PBX A, that call shall be released, without using any DPNSS 1 signalling on that channel;

if the state is indicated as busy and PBX A has no knowledge of the call, that call shall be released by sending a CRM containing the Clearing Cause: NT. A CIM is expected in response;

if the state is indicated as not equipped, PBX A shall release any call in progress at the time, and not use the channel.

If an LMRM is received, it shall be assumed that the traffic channel is in service. However, if this is not the case, individual calls on this channel may be rejected (eg see Paragraph 2.5.2 which considers the case when the channel is unavailable because it is back-busied).

2.10 INTERACTION OF FUNCTIONS

The following table refers to the relevant subparagraphs describing the way in which the functions which make up this service interact.

	Back-Busy	Loop-Back	Non-Looped-Back Test	Channel Status
Back-Busy	2.10.1	2.10.2	2.10.3	2.10.4
Loop-Back (same or separate)	2.10.2	2.10.5	2.10.6	2.10.7
Non-Looped-Back Test	2.10.3	2.10.6	2.10.8	2.10.9
Channel Status	2.10.4	2.10.7	2.10.9	2.10.10

NOTE: A second traffic-channel maintenance request shall not be sent until a response to the first is received (or the timeout has expired).

2.10.1 Back-Busy - Back-Busy

If both ends of a traffic channel apply back-busy such that the Back-Busy Requests cross over, both requests shall be carried out as if they had been received independently of each other.

If one end of a traffic channel applies back-busy after it has accepted a Back-Busy Request from the other end, the request shall be carried out.

2.10.2 Back-Busy - Loop-Back

If a back-busy condition is applied by either PBX at any time during a loop-back (including while establishing or cancelling it), the requests shall be carried out as if received independently of each other.

If a channel has been back-busied from PBX A, PBX B may not request A to loop-back the same channel either singly or as part of a separate-channel loop-back. If such a request is received, it shall be rejected by sending an LMRM containing the Rejection Cause: REJ and the String TCS (with the Parameter "Back Busy By Me").

2.10.3 Back-Busy - Non-Looped-Back Test

If a Back-Busy Request or Cancellation instruction crosses with either a Perform Test instruction or Test Request, both the back-busy and test signalling may continue as normal.

2.10.4 Back-Busy - Channel Status

If a Channel-Status Request and Back-Busy Request cross over, both requests shall be carried out as if they had been received independently of each other.

If a Channel-Status Request is received between the time that the Back-Busy Request is sent out and an acknowledgement to the Back-Busy Cancellation Request is received, the response shall indicate "Back-Busied By Me".

If a Channel-Status Request is received between the time that the response to the Back-Busy Request is sent and receipt of the Back-Busy Cancellation in Request, the response shall indicate "Back-Busied By You".

If a Channel-Status response is received indicating "Back-Busied By You" and the PBX has no knowledge of this fact, the Back-Busy Cancellation protocol shall be used to remove it.

If a Channel-Status response is received indicating "Back-Busied By Me", the channel shall be treated as if the Back-Busy protocol had just been completed.

2.10.5 Loop-Back - Loop-Back

If requests to loop-back a traffic channel cross over, a mechanism is used similar to that for when ISRMs cross over (SECTION 5). The PBX which has priority shall ignore the received request; the PBX which does not have priority shall abandon its attempt and process the incoming request.

If, after looping-back a channel, a Loop-Back Request is received, it shall be rejected by sending an LMRM containing the Rejection Cause: REJ and the String TCS (with the Parameter "Looped Back By Me").

2.10.6 Loop-Back - Non-Looped-Back Test

If a Loop-Back Request (separate or same channel) crosses with a Perform Test Instruction or Test Request, the Loop-Back Request shall be processed as normal and the Perform Test Instruction or Test Request rejected by means of an LMRM containing Rejection Cause:BY.

2.10.7 Loop-Back - Channel Status

If a Channel-Status Request and a Loop-Back Request cross over, both requests shall be carried out as if they had been received independently of each other.

If a Channel-Status Request is received between the time that the Loop-Back Request is sent out and acknowledgement to the loop-back cancellation request is received, the response shall indicate "Looped Back By Me".

If a Channel-Status Request is received between the time that the response to the Loop-Back Request is sent and receipt of the request for cancellation of the loop-back, the response shall indicate "Looped Back By You".

If a Channel-Status Request is received after sending Loop-Back Abort Request, the response shall indicate "Looped Back By You".

If a Channel-Status response is received indicating "Looped Back By You", and the PBX has no knowledge of this fact, the loop-back cancellation protocol shall be used to remove it.

If a Channel-Status response is received indicating "Looped Back By Me", and the Requesting PBX has no knowledge of this fact, the loop-back shall be cancelled.

2.10.8 Non-Looped-Back Test - Non-Looped-Back Test

When two Test Requests cross, or two Perform Test instructions cross, or a Perform Test instruction crosses with a Test Request, both PBXs shall respond with an LMRM containing Rejection Cause: BY, and otherwise ignore the received message.

2.10.9 Non-Looped-Back Test - Channel Status

If a Traffic-Channel Status Request crosses with a Perform Test instruction or Test Request, the returned status shall be "Out of Service" and the test shall proceed as normal.

2.10.10 Channel Status - Channel Status

If two Channel-Status Requests cross over, both requests are carried out as if they had been received independently of each other.

3 COMPLIANCE

The Traffic-Channel Maintenance Supplementary Service is an optional part of DPNSS 1 and its provision on a PBX is a matter for negotiation between a customer and his supplier (see FOREWORD in SECTION 0 of this specification). This subsection may be used as an aid to those negotiations.

NOTE: Whilst the provision of this Supplementary Service is optional, if it is provided, compliance with certain features of the service becomes mandatory.

The PBX functions (ie End, Transit or, Branching) have no relevance to this service.

The options available are given in TABLE 1. This table should be completed by a manufacturer to indicate the PBX capability and by a purchaser to indicate PBX requirements.

TABLES 2 to 13 indicate the features that are required/provided at each PBX. The pre-printed "YES" indicates that the feature is a mandatory part of the service for that PBX function.

TABLE 1

PBX FUNCTION		APPLICABLE TABLE
PBX supporting Back-Busy?		TABLE 2
PBX able to request Back-Busy?		TABLES 2 & 3
PBX supporting Loop-Back of Same Channel?		TABLE 4
PBX able to request Loop-Back of Same Channel?		TABLES 4 & 5
PBX supporting Loop-Back of Separate Channels?		TABLE 6
PBX able to request Loop-Back of Separate Channels?		TABLES 6 & 7
PBX supporting Non-Looped Test as a sender?		TABLE 8
PBX able to request Non-Looped Test as a receiver?		TABLES 8 & 9
PBX supporting Non-Looped Test as a receiver?		TABLE 10
PBX able to request Non-Looped Test as a sender?		TABLES 10 & 11
PBX supporting Channel-Status Request?		TABLE 12
PBX able to request Channel Status?		TABLES 12 & 13

TABLE 2

COMPLIANCE TABLE FOR A PBX THAT SUPPORTS BACK-BUSY		
SERVICE VARIANT		COMMENT
Able to accept a Back-Busy Request?	YES	
Able to reject a call received on a back-busied channel?	YES	
Able to accept a Back-Busy Cancellation Request?	YES	

TABLE 3

COMPLIANCE TABLE FOR A PBX ABLE TO REQUEST BACK-BUSY		
SERVICE VARIANT		COMMENT
Able to send a Back-Busy Request?	YES	
Able to send a Back-Busy Cancellation Request?	YES	

TABLE 4

COMPLIANCE TABLE FOR A PBX THAT SUPPORTS LOOP-BACK OF SAME CHANNEL		
SERVICE VARIANT		COMMENT
Able to accept a Same-Channel Loop-Back Request?		
Able to accept a Loop-Back Cancellation Request?	YES	
Able to request Cancellation of a Loop-Back?	YES	

TABLE 5

COMPLIANCE TABLE FOR A PBX ABLE TO REQUEST SAME-CHANNEL LOOP-BACK		
SERVICE VARIANT		COMMENT
Able to send a Same-Channel Loop-Back Request	YES	
Able to accept a Loop-Back Cancellation Request?	YES	
Able to cancel a loop-back?	YES	

TABLE 6

COMPLIANCE TABLE FOR A PBX THAT SUPPORTS LOOP-BACK OF SEPARATE CHANNEL		
SERVICE VARIANT		COMMENT
Able to accept a Separate-Channel Loop-Back Request?	YES	
Able to accept a Loop-Back Cancellation Request?	YES	
Able to request Cancellation of a Loop-Back?		

TABLE 7

COMPLIANCE TABLE FOR A PBX ABLE TO REQUEST SEPARATE-CHANNEL LOOP-BACK		
SERVICE VARIANT		COMMENT
Able to send a Separate-Channel Loop-Back Request?	YES	
Able to accept a Loop-Back Cancellation Request?	YES	
Able to cancel a loop-back?	YES	

TABLE 8

COMPLIANCE TABLE FOR A PBX THAT SUPPORTS NON-LOOPED-BACK TEST AS SENDER		
SERVICE VARIANT		COMMENT
Able to accept Perform Test instructions?	YES	Give details of tests supported

TABLE 9

COMPLIANCE TABLE FOR A PBX ABLE TO REQUEST NON-LOOPED-BACK TEST AS RECEIVER		
SERVICE VARIANT		COMMENT
Able to generate Perform Test instructions?	YES	Give details of tests supported

TABLE 10

COMPLIANCE TABLE FOR A PBX THAT SUPPORTS NON-LOOPED-BACK TEST AS RECEIVER		
SERVICE VARIANT		COMMENT
Able to accept Test Requests?	YES	Give details of tests supported

TABLE 11

COMPLIANCE TABLE FOR A PBX ABLE TO REQUEST NON-LOOPED-BACK TEST AS SENDER		
SERVICE VARIANT		COMMENT
Able to generate Test Requests?	YES	Give details of tests supported

TABLE 12

COMPLIANCE TABLE FOR A PBX THAT SUPPORTS CHANNEL-STATUS REQUEST		
SERVICE VARIANT		COMMENT
Able to accept a Channel-Status Request?	YES	

TABLE 13

COMPLIANCE TABLE FOR A PBX ABLE TO REQUEST CHANNEL STATUS		
SERVICE VARIANT		COMMENT
Able to send a Channel Status?	YES	
Calls in progress cleared if status discrepancy detected?		

DIGITAL PRIVATE NETWORK SIGNALLING SYSTEM NO 1 (DPNSS 1)

SECTION 28 - SUPPLEMENTARY SERVICE: REMOTE-ALARM REPORTING

CONTENTS

1	GENERAL	Page 2
2	REMOTE-ALARM REPORTING WITHIN DPNSS 1	Page 3
	2.1 DEFINITION.....	Page 3
	2.2 DESCRIPTION.....	Page 3
	2.3 OUTLINE OF OPERATION.....	Page 3
	2.3.1 Remote-Alarm Reporting.....	Page 4
	2.3.2 Remote-Alarm Request.....	Page 6
3	COMPLIANCE	Page 8

HISTORY

Issue 1 - March 1986

Issue 2 - December 1989 - Note: The heading text for this issue
incorrectly shows "Issue 3"

Issue 4 - March 2001 - Specification renamed as DPNSS[188]

1 GENERAL

1.1 This Section details the signalling requirements of DPNSS 1 for the Remote-Alarm Reporting Supplementary Service

1.2 Subsection 2 details the service within DPNSS 1.

1.3 Subsection 3 shows the Compliance.

1.4 The description is given in the form of Message Sequence Diagrams (MSDs) followed by explanatory text.

1.5 The text is referenced from MSDs at appropriate points in the sequence.

1.6 Message contents for successful calls are shown in MSDs. Messages and their contents for alternative sequences (eg for unsuccessful calls) are detailed in the text.

1.7 Coding of the contents of messages is given in SECTION 4.

2 REMOTE-ALARM REPORTING WITHIN DPNSS 1

2.1 DEFINITION

The Remote-Alarm Reporting Supplementary Service provides a network with the capability of reporting to a central point alarms raised by any PBX in the network.

2.2 DESCRIPTION

In a private network, a number of PBXs may not be attended (ie there may not be operators at all PBXs in the network). If any faults occur on those PBXs, a means is required of enabling the fault to be seen at another point in the network (either an attended PBX or a service centre).

The Remote-Alarm Reporting Supplementary Service allows an unattended PBX to report the following to another point in the network:

- the current alarm level,
- if the mains power has failed,
- whether maintenance personnel are on site or not.

These conditions are collectively known as the 'Alarm Status'.

The Service also allows a central point to interrogate remote PBXs to find their current Alarm Status.

The taking of any further action required as a result of an alarm being raised is not covered by this service.

The reporting protocol may be used when the status changes or at any other time that the Alarm Status is to be updated. Examples of why this may be done are:

- 1 Periodically (eg every night) to ensure that the information held is up to date.
- 2 As a result of an MMI request at the Reporting PBX.

2.3 OUTLINE OF OPERATION

The Remote-Alarm Reporting Supplementary Service is provided by means of the following separate signalling sequences.

2.3.1 REMOTE - ALARM REPORTING

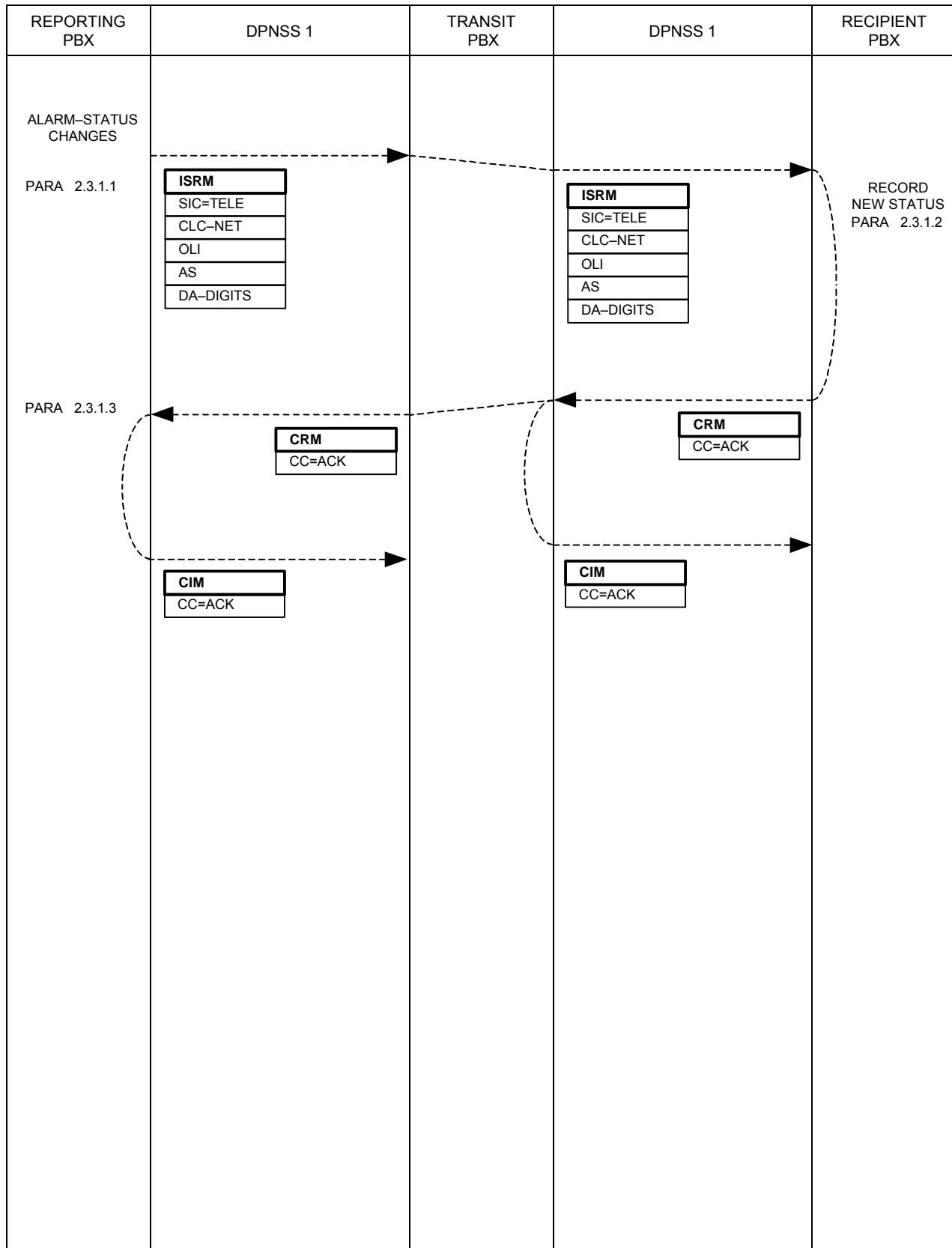

2.3.1.1 A PBX may hold a list of other points in the network which are to be informed when the Alarm Status of the PBX changes. When the change occurs, the PBX makes a Virtual Call to each one, informing it of the new status.

To make the call, the Reporting PBX selects a free Virtual Channel on the appropriate outgoing route and sends the ISRM containing Alarm Status (AS), the first Parameter of which indicates the new alarm level and (optionally) a mains power failure, and the optional second Parameter indicates whether or not maintenance staff are present on site. Display information may be included in the String TEXT. The Destination Address must be sufficient to route the call across the network to the desired destination. String OLI indicates the identity of the PBX reporting the change in Alarm Status (it is that address which would be used as the DA in a Remote-Alarm Request to that PBX).

2.3.1.2 On receipt of the ISRM containing AS, the Recipient PBX records the new status and takes any other necessary action (eg displaying the status). The call is cleared by sending a CRM containing Clearing Cause: ACK.

2.3.1.3 Any Clearing Cause other than ACK indicates a failure. In some cases, the reporting PBX may make a later repeat attempt.

2.3.2 REMOTE - ALARM REQUEST

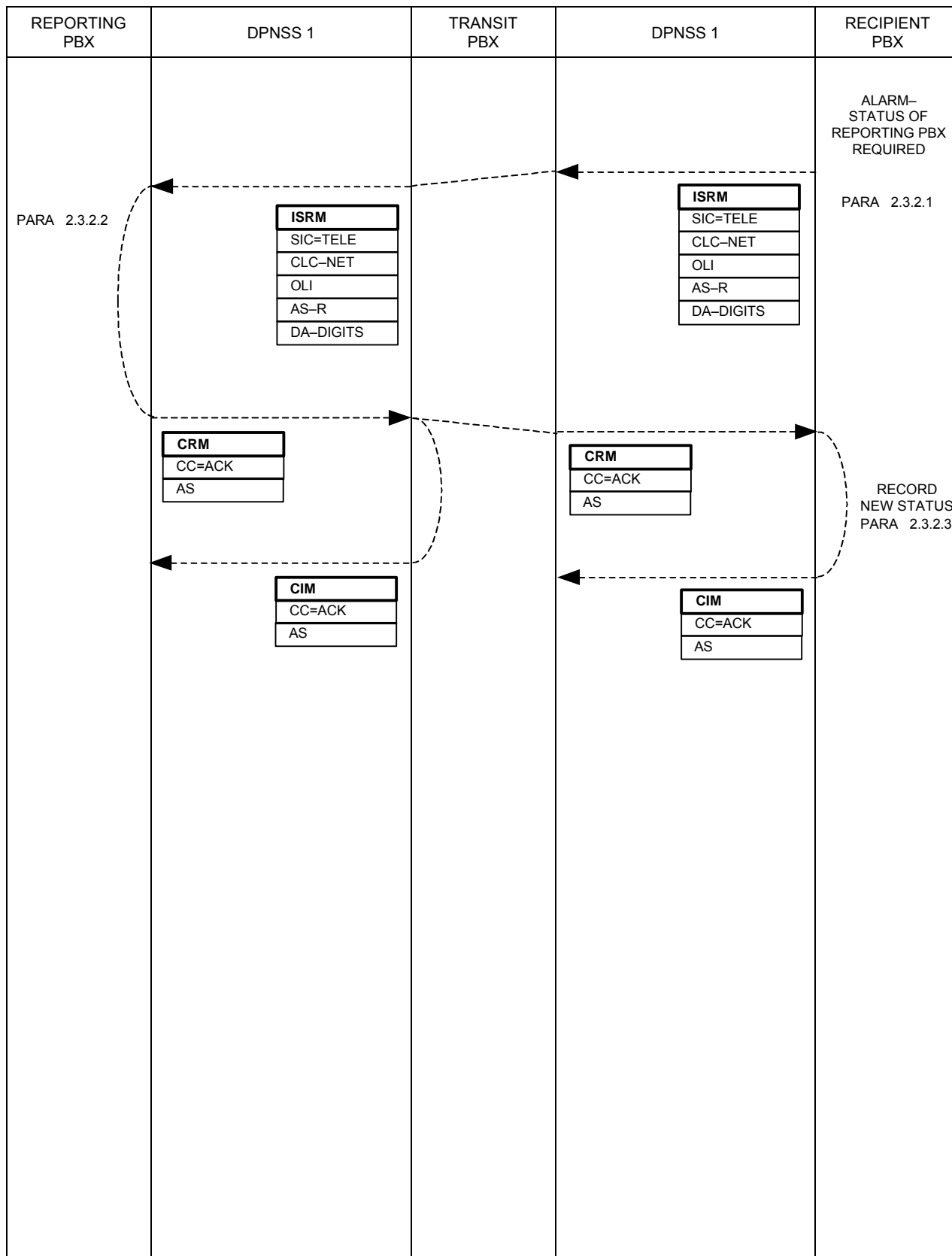

2.3.2.1 If a central PBX requires to know the Alarm Status at a remote PBX, it makes a Virtual Call to that PBX, informing it that the current Alarm Status is required.

To make the call, the PBX selects a free Virtual Channel on the appropriate outgoing route and sends an ISRM containing Alarm Status Request (AS-R). The Destination Address must be sufficient to route the call across the network to the desired destination. String OLI indicates the identity of the PBX requiring the current Alarm Status (it is that address which would be used as the DA in a Remote-Alarm Report to that PBX).

2.3.2.2 On receipt of the ISRM containing AS-R, the Reporting PBX returns the current Alarm Status and clears the call by sending a CRM containing Clearing Cause: ACK and the String AS. Display information may also be included in the String TEXT.

2.3.2.3 On receipt of the CRM containing CC: ACK and AS, the Requesting PBX records the current status and takes any other necessary action (eg displaying the status). The release of the call is completed by sending a CIM.

Receipt of a CRM containing a different Clearing Cause indicates that the Remote Alarm Request has failed and that no alarm information is known about the remote PBX. An appropriate indication shall be given to the requesting party.

3 COMPLIANCE

The Remote-Alarm Reporting Supplementary Service is an optional part of DPNSS 1 and its provision on a PBX is a matter for negotiation between a customer and his supplier (see FOREWORD in SECTION 0 of this specification). This subsection may be used as an aid to those negotiations.

NOTE: Whilst the provision of this Supplementary Service is optional, if it is provided, compliance with certain features of the service becomes mandatory.

Compliance with the service is considered in terms of the function(s) to be performed by the PBX, ie Transit, End or Branching, and whether the PBX can request the service.

The options available are given in TABLE 1. This table should be completed by a manufacturer to indicate the PBX capability and by a purchaser to indicate PBX requirements.

TABLE 1 should be ticked to indicate which function(s) the PBX is able/required to perform in the provision of the service in the network.

TABLES 2 to 4 indicate the features that are required/provided at each PBX. The pre-printed "YES" indicates that the feature is a mandatory part of the service for that PBX function.

TABLE 1

PBX FUNCTION		APPLICABLE TABLE
PBX supporting the service		TABLE 2
PBX able to request the service		TABLES 2 & 3
Transit PBX		TABLE 4

TABLE 2

COMPLIANCE TABLE FOR A PBX THAT SUPPORTS REMOTE-ALARM REPORTING		
SERVICE VARIANT		COMMENT
Able to accept a Remote-Alarm Report?	YES	
Able to request the Alarm Status of another PBX?		

TABLE 3

COMPLIANCE TABLE FOR A PBX THAT IS ABLE TO INFORM OTHER PBXs OF THE ALARM STATUS		
SERVICE VARIANT		COMMENT
Able to send a Remote-Alarm Report?	YES	
Able to respond correctly to a Remote-Alarm Request?	YES	

TABLE 4

COMPLIANCE TABLE FOR A TRANSIT PBX IN A NETWORK THAT SUPPORTS REMOTE-ALARM REPORTING		
SERVICE VARIANT		COMMENT
Able to act as a Transit for Remote-Alarm Reports?	YES	Inherent DPNSS 1 capability
Able to act as a Transit for Remote-Alarm Requests?	YES	Inherent DPNSS 1 capability

DIGITAL PRIVATE NETWORK SIGNALLING SYSTEM NO 1 (DPNSS 1)

SECTION 29 - SUPPLEMENTARY SERVICE: ADD-ON CONFERENCE

CONTENTS

1	GENERAL	Page 2
2	ADD-ON CONFERENCE BETWEEN ORDINARY EXTENSIONS WITHIN DPNSS 1	Page 3
2.1	DEFINITION	Page 3
2.2	DESCRIPTION	Page 3
2.3	OUTLINE OF OPERATION	Page 4
2.3.1	Add-On Enquiry	Page 5
2.3.2	Add-On Request	Page 8
2.3.3	Cleardown	Page 11
2.3.4	Split	Page 13
2.3.5	Obtain Conference Details	Page 15
2.3.6	Clear from Conference	Page 17
3	COMPLIANCE	Page 18

HISTORY

Issue 1 - March 1986

Issue 2 - December 1989

Issue 3 - March 2001 - Specification renamed as DPNSS[188]

1 GENERAL

- 1.1** This Section details the signalling requirements of DPNSS 1 for the Add-On Conference Supplementary Service.
- 1.2** Subsection 2 details the service within DPNSS 1.
- 1.3** Subsection 3 shows the Compliance.
- 1.4** The description is given in the form of Message Sequence Diagrams (MSDs) followed by explanatory text.
- 1.5** The text is referenced from MSDs at appropriate points in the sequences.
- 1.6** Message contents for successful calls are shown in MSDs. Messages and their contents for alternative sequences (eg for unsuccessful calls) are detailed in the text.
- 1.7** Coding of the contents of messages is given in SECTION 4.
- 1.8 THIS SUPPLEMENTARY SERVICE MAY BE SUPPORTED ONLY IN CONJUNCTION WITH THE THREE-PARTY SERVICE (SECTION 13)**

2 ADD-ON CONFERENCE SERVICE WITHIN DPNSS

2.1 DEFINITION

The Add-On Conference Supplementary Service permits the controller of a Three-Party Service conference to expand it to four or more parties.

2.2 DESCRIPTION

This Supplementary Service allows a Three-Party Service conference to grow to four or more parties, depending on the capacity of the conference bridge in use at the Conference PBX.

The number of parties in a conference is subject to change. While the conference has three parties, the facilities of both Three-Party Service and Add-On Conference Service are available; but while the conference has four or more parties the only conference facilities available are those of the Add-On Conference Service. If the number of parties goes down to two, the conference reverts to a Simple Call.

The following facilities are available to all parties:

- i. Place the conference on Hold and make an Add-On Enquiry Call, using Single-Channel Working as far as the Conference PBX to facilitate subsequent Add-On. Following establishment, Shuttle between the Enquiry Call and the conference, and release of the Enquiry Call are possible. The Hold Supplementary Service (SECTION 12) may be used to place the conference on Hold.
- ii. Add the called party of an Add-On Enquiry Call on to the conference.
- iii. Clear down the complete conference.
- iv. Split a selected party away from the conference in order to talk in private to or release that party.
- v. Obtain details of parties currently participating in the conference.
- vi. Clear from the conference.

2.3 OUTLINE OF OPERATION

These facilities are implemented using the following separate signal sequences, which relate to the Message Sequence Diagrams.

2.3.1 Add-On Conference - Add-On Enquiry

This sequence is used to make an Add-On Enquiry Call. It is similar to a Three-Party Service Enquiry Call, but is forced to use the existing path as far as the Conference PBX regardless of the Destination Address.

2.3.2 Add-On Conference - Add-On Request

This sequence is used after Add-On Enquiry to Add-On the enquired-to party to the conference.

2.3.3 Add-On Conference - Cleardown

This sequence is used if a party requests cleardown of the entire conference.

2.3.4 Add-On Conference - Split

This sequence is used if a party requests splitting of a selected party from the conference and connection to that party.

2.3.5 Add-On Conference - Obtain Conference Details

This sequence is used if any party requires details of the other parties.

2.3.6 Add-On Conference - Clear from Conference

This sequence is used if any party clears from the conference.

Except during Add-On Enquiry Call establishment, Transit PBXs, if any, are transparent to all signalling and are neither shown nor described.

It is assumed that none of the parties is on the same PBX as the conference bridge. If a party is on the Conference PBX then DPNSS 1 signalling between that party and the Conference PBX does not apply.

It should be noted that the connections between the Conference PBX and each of the other PBXs involved in the conference are treated as separate calls in respect of DPNSS 1 signalling.

2.3.1 ADD-ON CONFERENCE - ADD-ON ENQUIRY

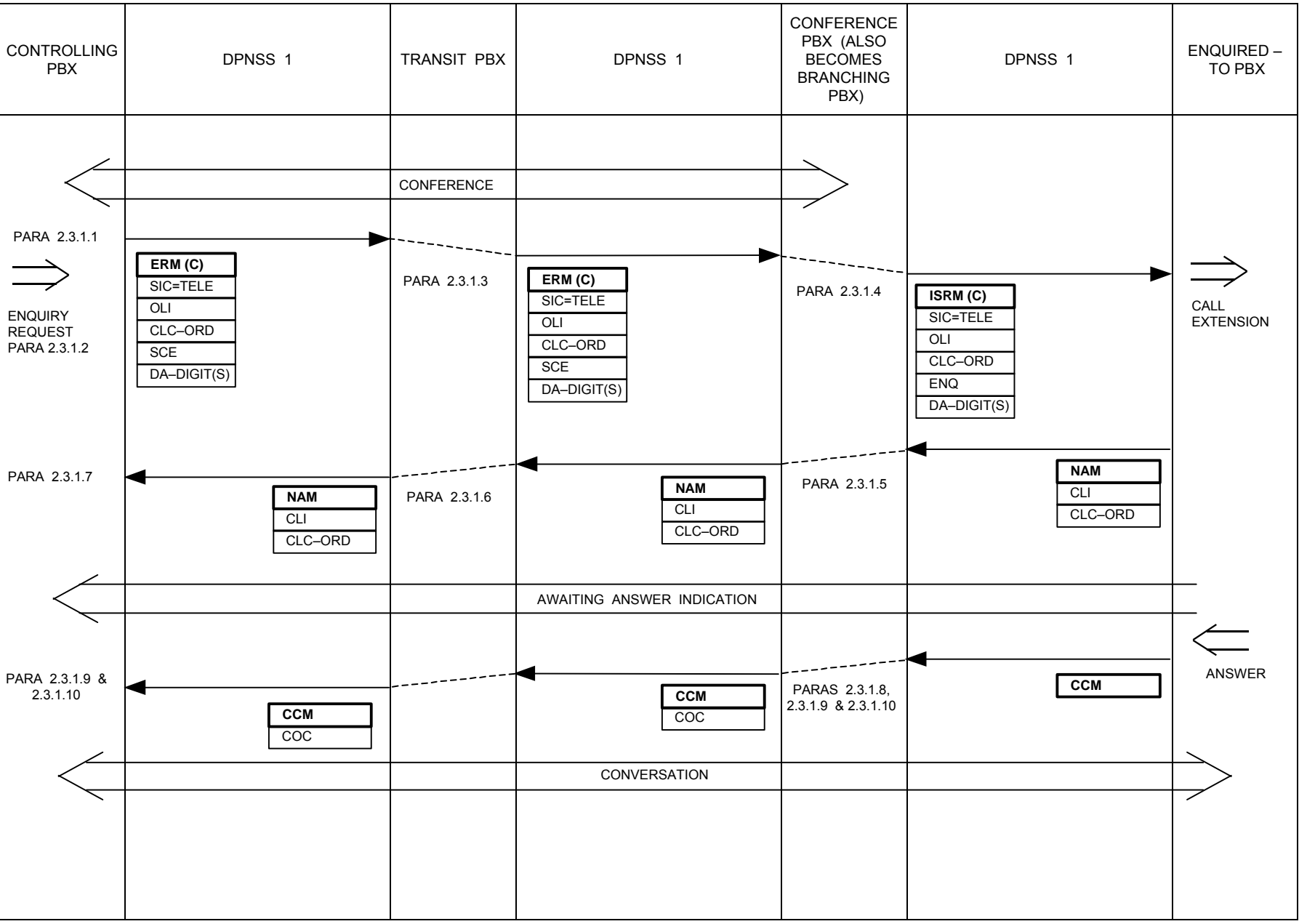

2.3.1.1 Any extension involved in a conference may place the conference on Hold and establish a Three-Party Service Enquiry Call. This is described in SECTION 13, paragraph 2.3.10.7 for the case of a Three-Party Conference, but the same applies to conferences of more than three parties established according to the rules of this Section.

If there is a possibility that the called party will subsequently require to be added on to the conference then it is important that the Enquiry Call is routed via the Conference PBX. The Three-Party Service Enquiry Call does not guarantee routing via the Conference PBX. The Add-On Enquiry Call, however, by means of the End-to-End Recall Message (ERM), always routes via the Conference PBX regardless of the Destination Address and therefore facilitates subsequent Add-On.

Depending on its design, a PBX may either treat all enquiry requests from conference members as Add-On Enquiry Requests, or, alternatively, may require the user to specify which type of Enquiry Call is required.

As far as this signalling sequence is concerned, the party making the Enquiry Call is known as the controlling party and that party's PBX is known as the Controlling PBX.

Before making an Add-On Enquiry Call, the conference must be placed on Hold. This is done either as a result of a separate request by the user before the Add-On Enquiry Request, or as part of the Add-On Enquiry Request itself. The Hold procedure defined for the Hold Supplementary Service (SECTION 12) may be used, and if rejection occurs, the Add-On Enquiry Request must be rejected.

2.3.1.2 After placing the conference on Hold, the Controlling PBX sends either an End-to-End Recall Message Complete [ERM(C)] or an End-to-End Recall Message Incomplete [ERM(I)] towards the Conference PBX. The ERM contains the SIC, OLI, CLC, Single-Channel Enquiry (SCE) and the Destination Address. Note that the contents of the ERM are the same as the contents of an RM when used to establish a Three-Party Service Enquiry Call via the same channel (SECTION 13, paragraph 2.3.2). If an ERM(I) is sent, any subsequent information may be sent in SSRMs.

2.3.1.3 A Transit PBX passes the ERM and any subsequent SSRMs on.

2.3.1.4 The Conference PBX treats an ERM containing SCE the same as an RM containing SCE. Branching must occur since the Conference PBX acts as the End PBX for the existing call. Assuming the Destination Address indicates an Off-PBX address, an outgoing DPNSS channel is selected and an ISRM containing the SIC, OLI, CLC, Enquiry (ENQ) and the Destination Address is sent. The incoming traffic channel is

disconnected from the conference and connected to the outgoing traffic channel.

In addition, if there is no more capacity on the conference bridge, it returns to the Controlling PBX a NIM containing Add-On Conference - No Add-On (AC-NAO) to indicate that subsequent Add-On will not be possible (unless circumstances change).

2.3.1.5 The Conference PBX continues to act as a Three-Party Service Branching PBX and passes back the NAM and subsequent CCM.

If the Enquiry Call is rejected, the Conference PBX sends back an RRM containing the Rejection Cause.

If one or more parties clear from the held conference so as to leave only one party on Hold, the Conference PBX sends EEMs containing TWP to the Controlling PBX and the remaining held party's PBX. The Enquiry Call is unaffected and the Conference PBX becomes an ordinary Branching PBX.

2.3.1.6 Transit PBXs pass back any NIMs and the NAM or RRM.

2.3.1.7 Receipt of a NAM or RRM will indicate success or rejection, respectively to the Controlling PBX.

On receipt of a NIM containing AC-NAO, the Controlling PBX may give an appropriate indication to the calling party.

If, after sending the ERM(C) or ERM(I), an EEM containing TWP is received, this indicates that the conference has cleared down to two parties and the ERM will not be acted upon. The Controlling PBX may repeat the Enquiry attempt using Three-Party Service Procedures.

2.3.1.8 When the Enquiry Call is answered, the CCM will have String COC added by the Conference PBX.

2.3.1.9 After answer, the Three-Party Service Shuttle procedures (SECTION 13, paragraph 2.3.6) may be used to allow the controlling party to Shuttle between the Enquiry Call and the conference.

2.3.1.10 Three-Party Service Enquiry Call termination procedures (SECTION 13, paragraph 2.3.4) apply. Note that unless Shuttle has taken place, the SCRIM and SCIM will contain String COC to denote the Connected Call. The Controlling PBX may terminate the Enquiry Call at any time after sending the ERM.

2.3.2 ADD-ON CONFERENCE - ADD-ON REQUEST

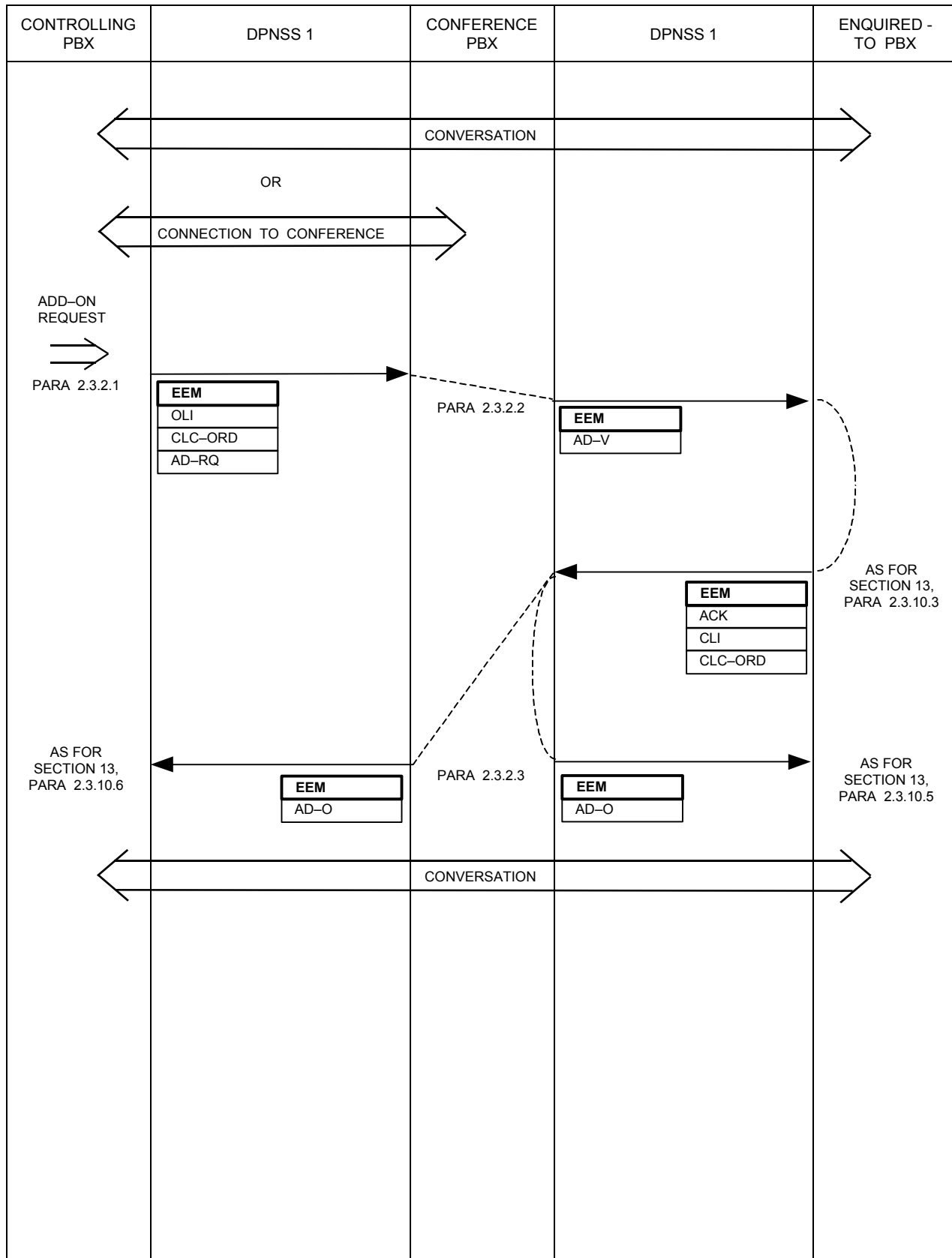

2.3.2.1 Following the establishment and answer of an Add-On Enquiry Call, the Enquiry Call's controlling party may request Add-On. This may occur either while the controlling party is connected to the enquired-to party or, as a result of Shuttle, while the controlling party is connected to the conference. The Controlling PBX sends an EEM containing Add-On Request (AD-RQ), OLI and CLC, as for Three-Party Service Add-On (SECTION 13, paragraph 2.3.10.1).

2.3.2.2 On receipt of an EEM containing AD-RQ, the Conference PBX checks that there is sufficient capacity on the bridge for the proposed Add-On. The Conference PBX sends out an EEM containing Add-On Validation (AD-V) to the Enquired-to PBX and awaits a response.

If the conference is full, or the party cannot be added on for any other reason, the request is rejected by returning an EEM containing REJ.

2.3.2.3 On receipt of an EEM containing ACK, CLI and CLC from the Enquired-to PBX, the Conference PBX checks that the enquired-to party is allowed to be connected to the other parties in the conference. If so, the enquired-to party's and the controlling party's traffic channels are connected into the conference. An EEM containing Added On (AD-O) is sent to the Enquired-to PBX and also to the Controlling PBX.

If an EEM containing SNU is received from the Enquired-to PBX, the Conference PBX may still go ahead with Add-On although it will not know the identity and category of the party concerned and will be unable to check its compatibility with the other parties. Since an EEM containing AD-O would not be understood, an EEM containing RECON is sent instead to the Enquired-to PBX to ensure that if the party has been placed on Hold, it is reconnected.

If an EEM containing REJ is received from the Enquired-to PBX, or if the party is not allowed to be connected to the other parties in the conference, the Conference PBX rejects the Add-On Request by sending to the Controlling PBX an EEM containing REJ.

If the Conference PBX does not receive a response within 5 seconds it sends an EEM containing REJ to the Controlling PBX.

If a CRM is received from one of the existing conference parties, the Add-On is allowed to continue. However, if there is only one conference party remaining and the Add-On Request is subsequently rejected, String TWP is included in the EEM containing REJ, an EEM containing TWP is sent to the remaining party, and the Conference PBX becomes an ordinary Branching PBX.

If a CRM is received from the Enquired-to PBX or from the last of the conference parties, an SCRIM (containing COC in the case of the connected party) is sent to the Controlling PBX and an SCIM is expected in response. The Add-On is aborted.

2.3.2.4 The process of making an Add-On Enquiry Call and adding it on may be repeated by any party until the limit of the conference bridge is reached.

To facilitate certain other facilities described in later paragraphs, each conference party is assigned an index.

Index 1 is assigned to the party which requested the initial Three-Party Service Add-On, Index 2 is assigned to the party which was the held party before the Three-Party Add-On, and Index 3 is assigned to the connected party before the Three-Party Add-On. Indices 4 onwards are assigned in sequence as further parties are added on. A party retains the same index until either the party is removed from the conference (as a result of split or that party clearing) or the conference terminates (as a result of other parties clearing).

2.3.3 ADD-ON CONFERENCE - CLEARDOWN

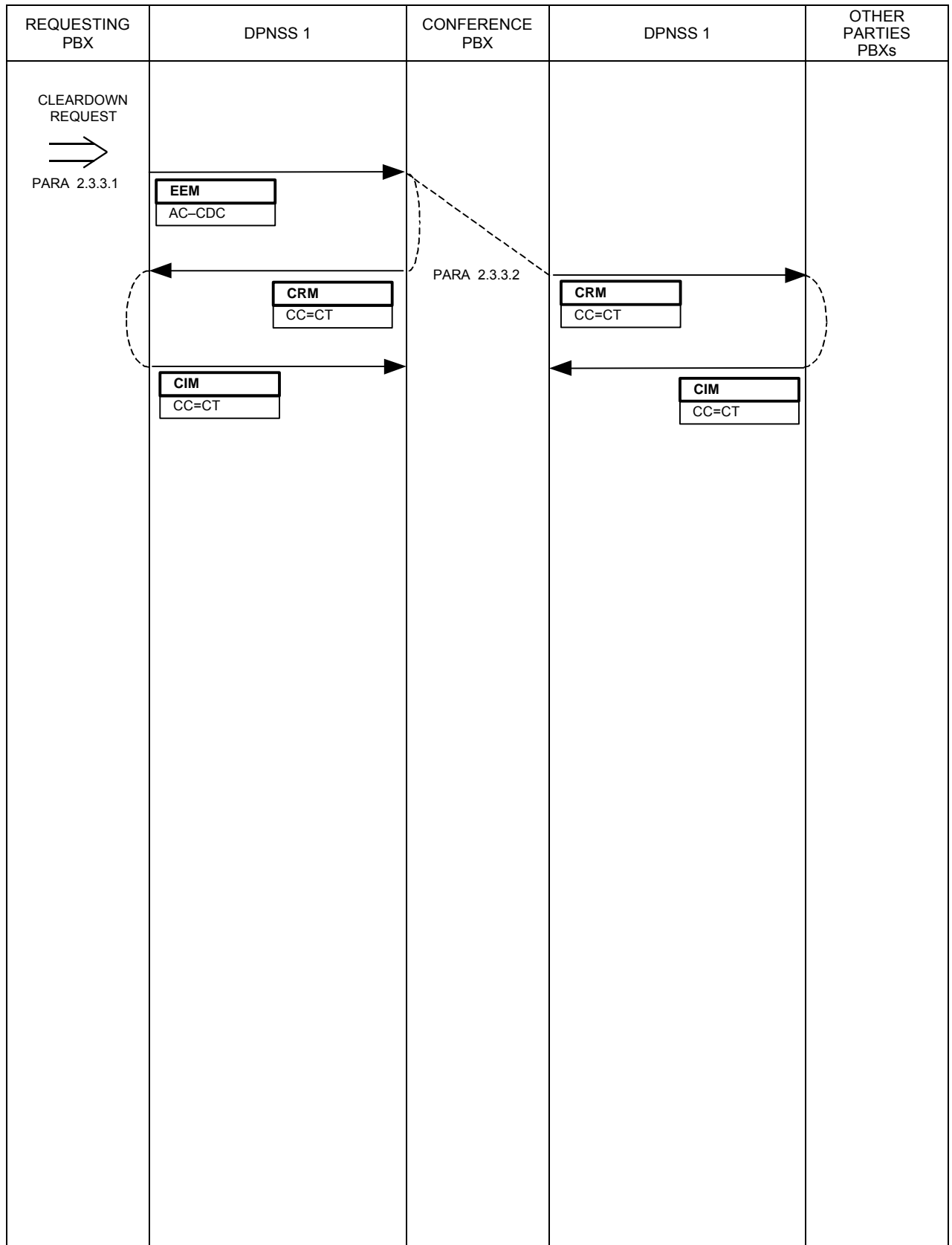

2.3.3.1 While an Add-On Conference is in progress, a party may request cleardown of the conference. An EEM is sent from the party's PBX to the Conference PBX with the Supplementary Information String AC-CDC.

2.3.3.2 On receipt of an EEM containing AC-CDC, the Conference PBX disconnects all parties from the conference and sends a CRM containing Clearing Cause: CT to each party involved in the conference. CIMs are expected in response.

If any party has an Enquiry Call, the Enquiry Call remains connected. Instead of a CRM, an SCRM is sent towards the party concerned and an SCIM is expected in response. If the party was connected to the conference at the time (with the Enquiry Call on hold), String COC is included in the SCRM and SCIM.

2.3.4 ADD-ON CONFERENCE - SPLIT

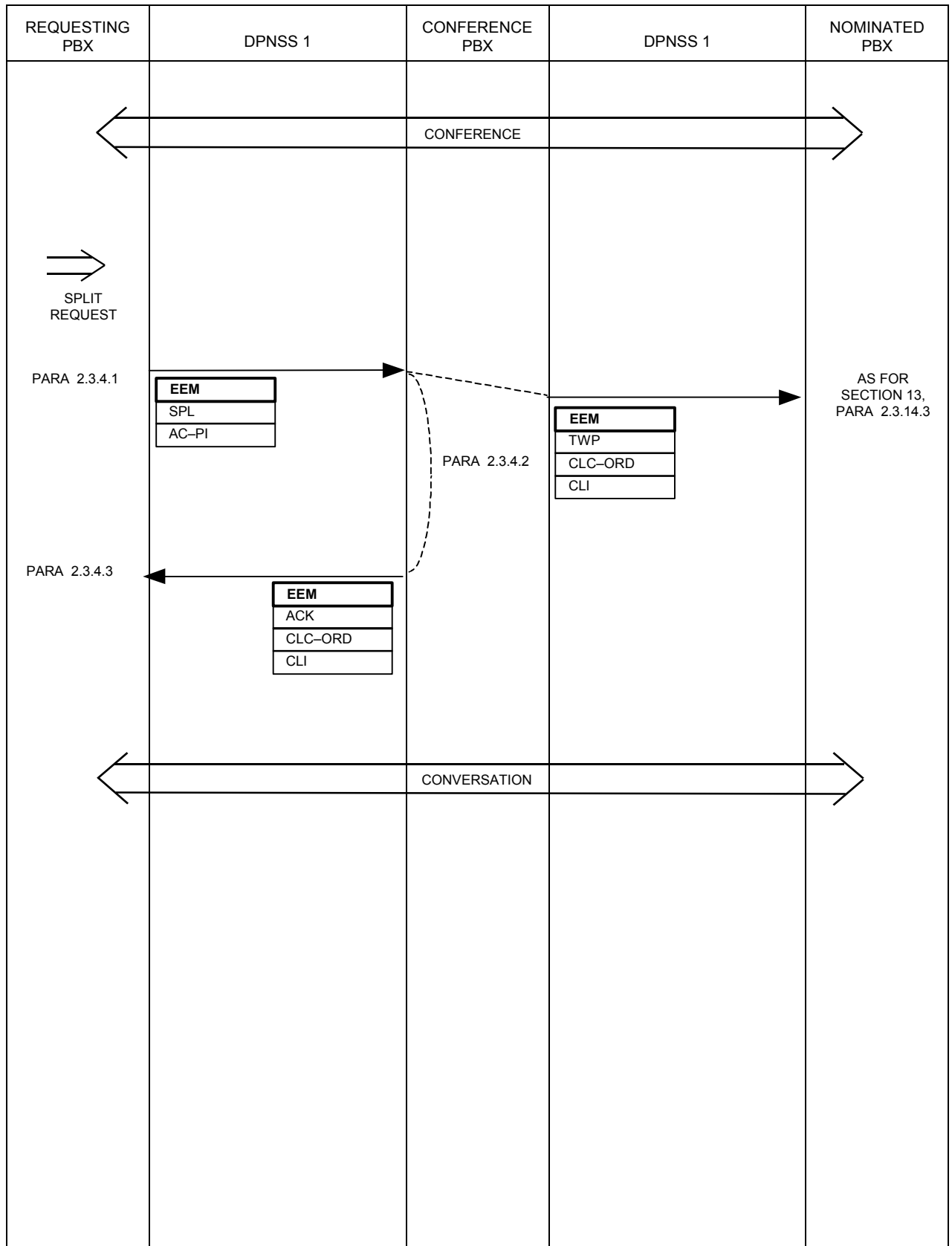

2.3.4.1 A conference party may request Split, in order to be connected in private to a particular member of the conference, leaving the rest of the conference on Hold. An EEM containing Split (SPL) and AC-PI is sent to the Conference PBX. The Parameter of AC-PI contains the Index of the party to which connection is requested. The Requesting PBX should reject the request if the requesting party already has an Enquiry Call.

If the Hold Supplementary Service is used, the String HOLD-REQ should be included in the EEM.

2.3.4.2 On receipt of an EEM containing SPL, the Conference PBX disconnects the requesting party and the nominated party from the conference and connects them together. An EEM containing TWP (with Parameter CALL DIR = T) together with the requesting party's identity and CLC is sent to the Nominated PBX, and an EEM containing ACK and the nominated party's identity and CLC is returned to the Requesting PBX.

The resultant call involving the requesting party and the nominated party is treated as an Enquiry Call for which the requesting party is the controlling party.

If split cannot be performed, for example because the Party Index is invalid, the Conference PBX returns an EEM containing SU.

If, on receipt of an EEM containing SPL, there are only three parties in the conference, the rules of Three-Party Service: Split (SECTION 13, paragraph 2.3.14) apply.

2.3.4.3 Following receipt of an EEM containing ACK, the Requesting PBX treats the call to the nominated party as an Enquiry Call. The usual actions available to a conference-enquiry-call controller are now available; these include terminating the Enquiry Call, shuttling between the Enquiry Call and the conference and adding the Enquiry Call back on to the conference.

ADD-ON CONFERENCE – OBTAIN CONFERENCE DETAILS

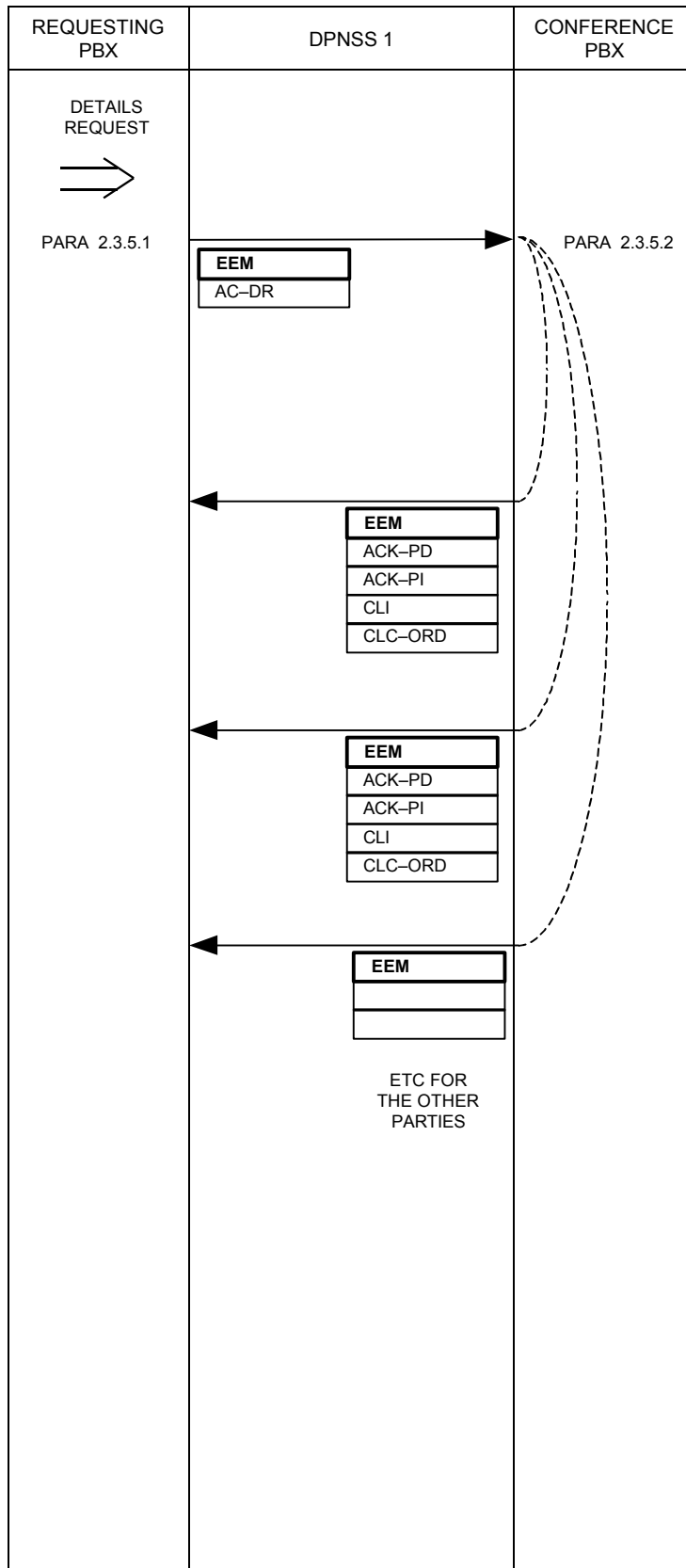

2.3.5.1 While an Add-On Conference is in progress, any party may request details of the Conference PBX and the other parties. An EEM with Supplementary Information String Add-On Conference Details Request (AC-DR) is sent from the Requesting Party's PBX to the Conference PBX.

2.3.5.2 The Conference PBX responds to an EEM containing AC-DR by returning one EEM for each party in the conference, including the requesting party. Each EEM contains Strings Add-On Conference Party Details (AC-PD), AC-PI (containing the Party Index), CLI and CLC. The optional Parameter of String AC-PD is used to indicate whether the party is the one to whom the details are being sent, and whether the party is the last (no more EEMs to follow).

The first EEM sent may optionally contain String Add-On Conference - Conference Bridge Identity (AC-CBI), the Parameter of which is the network address of the conference bridge.

2.3.6 Add-On Conference - Clear From Conference

If the conference contains four or more parties and a party clears from the conference, the Conference PBX, on receipt of a CRM, disconnects that party from the conference and responds with a CIM.

If the conference contains three parties then the rules of the Three-Party Service: Clear Down After Add-On apply (SECTION 13, paragraph 2.3.11).

3 COMPLIANCE

The Add-On Conference Supplementary Service is an optional part of DPNSS 1 and its provision on a PBX is a matter for negotiation between the customer and his supplier (see FOREWORD in SECTION 0 of this specification). This Subsection may be used as an aid to those negotiations.

NOTE: Whilst the provision of this Supplementary Service is optional, if it is provided, compliance with certain features of the service becomes mandatory.

Compliance with the service is considered in terms of the function(s) to be performed by the PBX, ie Transit, End or Branching, and the extent to which extensions or operators on the PBX can request the service.

The options available are given in TABLE 1. This table should be completed by a manufacturer to indicate PBX capability and by a purchaser to indicate PBX requirements.

TABLES 2 to 6 indicate the features that are required/provided at each PBX. The pre-printed "YES" indicates that the feature is a mandatory part of the service for that PBX function.

TABLE 1

PBX FUNCTION		APPLICABLE TABLE
A Conference PBX with operators or extensions, some of which can request the service.		TABLES 2 & 4
PBX supporting Single-Channel Working for the service with operators or extensions, some of which can request the service.		TABLES 2, 3 4 & 5
PBX with operators or extensions, none of which can request the service.		TABLE 2
PBX supporting Single-Channel Working for the service and having operators or extensions, none of which can request the service.		TABLES 2 & 3
Transit PBX		TABLE 6
Conference PBX supporting Single-Channel Working with no extensions or operators.		TABLE 3

TABLE 2

COMPLIANCE TABLE FOR A CONFERENCE PBX WITH OPERATORS OR EXTENSIONS IN A NETWORK WHICH SUPPORTS THE THREE-PARTY SERVICE AND THE ADD-ON CONFERENCE SERVICE		
SERVICE VARIANT		COMMENT
Able to accept incoming Enquiry Calls and being Added-On to and Split from conference?	YES	As for Three-Party Service

TABLE 3

COMPLIANCE TABLE FOR A CONFERENCE PBX IN A NETWORK WHICH SUPPORTS THE THREE-PARTY SERVICE AND THE ADD-ON CONFERENCE SERVICE USING SINGLE-CHANNEL WORKING		
SERVICE VARIANT		COMMENT
Able to accept incoming Add-On Enquiry Requests from an existing conference party on another PBX via the same channel?	YES	
Able to respond correctly to a Shuttle command from a Controlling PBX via the same channel?	YES	
Able to add a party into a conference and Split a party from a conference on request from a Controlling PBX via the same channel?	YES	
Able to clear down a conference on request from a party on another PBX via the same channel?	YES	
Able to respond to an Add-On Conference Details - Request from a party on another PBX via the same channel?		

TABLE 4

ADDITIONAL COMPLIANCE TABLE FOR A CONFERENCE PBX WITH OPERATORS OR EXTENSIONS THAT ARE ABLE TO REQUEST ADD-ON CONFERENCES		
SERVICE VARIANT		COMMENT
Able to establish a conference Enquiry Call to an extension on another PBX via a separate channel?	YES	
Able, as a Controlling PBX, to Shuttle between a conference and an Enquiry Call via a separate channel?		Internal PBX function
Able, as a Controlling PBX, to Add-On to a conference an Enquiry Call via a separate channel?	YES	
Able to Split a party from a conference on the same PBX and become a Controlling PBX for the resulting Enquiry Call via a separate channel?		
Able to clear down an entire conference on the same PBX?		
Able to request details of a conference on the same PBX?		Internal PBX function
Able to respond to an Add-On Conference Details - Request from a party on another PBX via the same channel?		
Able to request cleardown of an entire conference on another PBX?		
Able to request details of a Conference or another PBX?		

TABLE 5

ADDITIONAL COMPLIANCE TABLE FOR A PBX WITH OPERATORS OR EXTENSIONS WHICH ARE ABLE TO REQUEST ADD-ON CONFERENCES USING SINGLE-CHANNEL WORKING		
SERVICE VARIANT		COMMENT
Able to establish a conference Enquiry Call via the same channel when the conference bridge is on another PBX?	YES	
Able, as a Controlling PBX, to Shuttle between a conference and an Enquiry Call via the same channel?		
Able, as a Controlling PBX, to Add-On to a conference an Enquiry Call via the same channel?	YES	
Able to Split a party from a conference on a different PBX and become a Controlling PBX for the resulting Enquiry Call via the same channel?		

TABLE 6

COMPLIANCE TABLE FOR A TRANSIT PBX IN A NETWORK THAT SUPPORTS THREE-PARTY SERVICE AND ADD-ON CONFERENCE SERVICE		
SERVICE VARIANT		COMMENT
Able to pass on messages relating to Add-On Enquiry, Add-On, Split, Cleardown of Conference and Conference Details?	YES	Inherent DPNSS1 capability

DIGITAL PRIVATE NETWORK SIGNALLING SYSTEM NO 1 (DPNSS 1)

SECTION 30 - SUPPLEMENTARY SERVICE: TIME SYNCHRONISATION

CONTENTS

1	GENERAL	Page 2
2	TIME SYNCHRONISATION SERVICE WITHIN DPNSS 1	Page 3
	2.1 DEFINITION.....	Page 3
	2.2 DESCRIPTION.....	Page 3
	2.3 OUTLINE OF OPERATION.....	Page 3
	2.3.1 Time Notification.....	Page 4
	2.3.2 Time Request.....	Page 6
3	COMPLIANCE	Page 8

HISTORY

Issue 1 - March 1986

Issue 2 - December 1989

Issue 3 - March 2001 - Specification renamed as DPNSS[188]

1 GENERAL

1.1 This Section details the signalling requirements of DPNSS 1 for the Time Synchronisation Supplementary Service.

1.2 Subsection 2 details the service within DPNSS 1.

1.3 Subsection 3 shows the Compliance.

1.4 The description is given in the form of Message Sequence Diagrams (MSDs) followed by explanatory text.

1.5 The text is referenced from MSDs at appropriate points in the sequence.

1.6 Message contents for successful calls are shown in MSDs. Messages and their contents for alternative sequences (eg for unsuccessful calls) are detailed in the text.

1.7 Coding of the contents of messages is given in SECTION 4.

2 TIME SYNCHRONISATION SERVICE WITHIN DPNSS 1

2.1 DEFINITION

The Time Synchronisation service allows time and date to be synchronised at different PBXs in a DPNSS 1 network.

2.2 DESCRIPTION

Each PBX in a network may maintain its own clock so that time and date are available for purposes such as call logging, operator display, fault reporting, etc. The Time Synchronisation service permits the adjustment of time or date at one PBX (eg at the start of British Summer Time) to be reflected at other PBXs in the network. Virtual Calls are made from the PBX whose time has been adjusted to other PBXs. The same procedure may be used periodically to ensure that all clocks are synchronised; differences may arise owing to running at slightly different speeds, power failure, etc.

A facility is also provided whereby a PBX which needs to know the time and date, eg following a power failure, may obtain them from another PBX.

2.3 OUTLINE OF OPERATION

This facility is implemented using the following signalling sequences:

- 2.3.1 Time Notification,
- 2.3.2 Time Request.

2.3.1 TIME NOTIFICATION

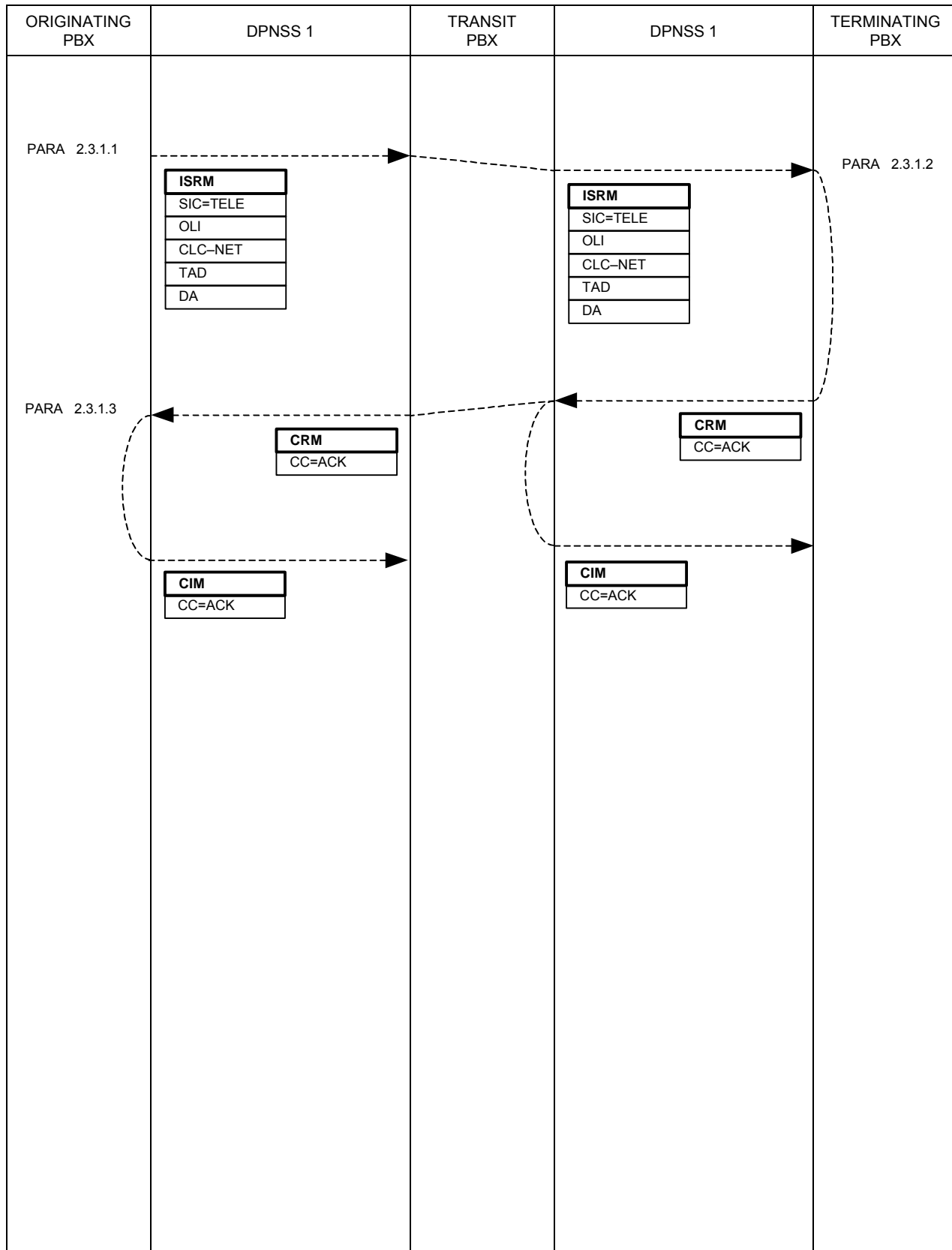

2.3.1.1 A PBX may contain a list of addresses of PBXs to be informed of the time and date whenever a change is made, or periodically. This is done by originating a Virtual Call with the address of the PBX to be informed as the Destination Address. The ISRM also contains Strings Time and Date (TAD) CLC-NET and OLI. String TAD Parameters carry the new date (year, month and day) and time (hour, minute and second). String OLI conveys the address of the Originating PBX (ie that address which would be used as the DA in a Time - Request to that PBX).

2.3.1.2 The Terminating PBX updates its time and date, and clears the call by sending a CRM with Clearing Cause: ACK. A CIM is expected in response.

2.3.1.3 Receipt of a CRM containing Clearing Cause: ACK indicates that the time and date have been successfully received at the Terminating PBX.

Any Clearing Cause other than ACK indicates a failure. In some cases, the PBX may make a repeat attempt later.

2.3.2 TIME REQUEST

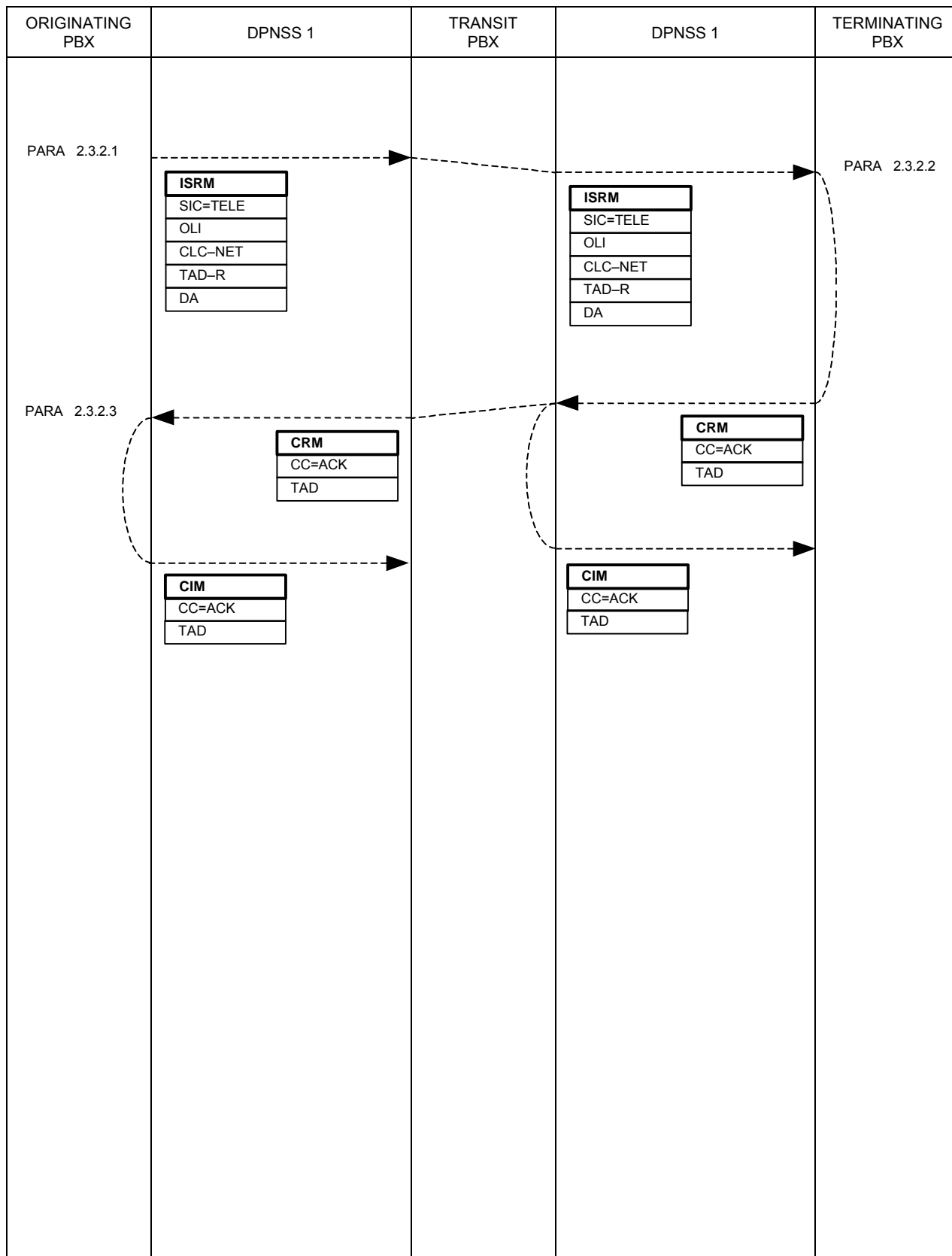

2.3.2.1 A PBX may have registered the addresses of other PBXs from which time and date can be obtained if required. The request is made by originating a Virtual Call with the address of another PBX as the Destination Address. The ISRM also contains Strings TAD-R (Time and Date Request), CLC-NET and OLI. String OLI conveys the address of the Originating PBX (ie that address which would be used as the DA in a Time - Notification to that PBX).

2.3.2.2 The Terminating PBX clears the call by sending a CRM containing Clearing Cause: ACK and String TAD. String TAD Parameters convey the time and date. A CIM is expected in response.

If the PBX cannot give the Time and Date, the CRM will contain the Clearing Cause: Service Temporarily Unavailable (STU) and no TAD String.

2.3.2.3 Receipt of a CRM containing Clearing Cause: ACK and String TAD indicates that the request was successful and that the time and date may be used for synchronisation of the Requesting PBX.

Any Clearing Cause other than ACK indicates a failure. In some cases, the PBX may make a repeat attempt later, or optionally request Time and Date from another PBX.

3 COMPLIANCE

The Time Synchronisation Supplementary Service is an optional part of DPNSS 1 and its provision on a PBX is a matter for negotiation between a customer and his supplier (see Foreword in SECTION 0 of this specification). This Subsection may be used as an aid to those negotiations.

NOTE: Whilst the provision of this Supplementary Service is optional, if it is provided, compliance with certain features of the service becomes mandatory.

Compliance with the service is considered in terms of the function(s) to be performed by the PBX, ie Transit, End or Branching, and whether the PBX can request the service.

The options available are given in TABLE 1. This table should be completed by a manufacturer to indicate the PBX capability and by a purchaser to indicate PBX requirements.

TABLES 2 to 4 indicate the features that are required/provided at each PBX. The pre-printed "YES" indicates that the feature is a mandatory part of the service for that PBX function.

TABLE 1

PBX FUNCTION		APPLICABLE TABLE
PBX able to synchronise its time and date to a Master PBX		TABLE 2
PBX able to supply time and date to other PBXs		TABLE 3
Transit PBX		TABLE 4

TABLE 2

COMPLIANCE TABLE FOR A PBX WHICH CAN SYNCHRONISE ITS TIME AND DATE FROM A MASTER PBX		
SERVICE VARIANT		COMMENT
Able to synchronise time and date when notified from another PBX?	YES	
Able to request time and date from another PBX?		

TABLE 3

COMPLIANCE TABLE FOR A PBX THAT IS ABLE TO SUPPLY TIME AND DATE TO OTHER PBXs		
SERVICE VARIANT		COMMENT
Able to send time and date to other PBXs when instructed?	YES	Specify action taken
Able to respond to time and date requests from other PBXs?	YES	

TABLE 4

COMPLIANCE TABLE FOR A TRANSIT PBX IN A NETWORK THAT SUPPORTS TIME SYNCHRONISATION		
SERVICE VARIANT		COMMENT
Able to act as a Transit for time and date notification?	YES	Inherent DPNSS 1 capability
Able to act as a Transit for time and date requests?	YES	Inherent DPNSS 1 capability

DIGITAL PRIVATE NETWORK SIGNALLING SYSTEM NO 1 (DPNSS 1)

SECTION 31 - SUPPLEMENTARY SERVICE: CALL BACK WHEN NEXT USED

CONTENTS

1	GENERAL	Page 2
2	CALL BACK WHEN NEXT USED BETWEEN ORDINARY EXTENSIONS WITHIN DPNSS 1	Page 3
2.1	DEFINITION	Page 3
2.2	DESCRIPTION	Page 3
2.3	OUTLINE OF OPERATION	Page 3
2.3.1	CBWNU Request	Page 4
3	COMPLIANCE	Page 7

HISTORY

Issue 1 - March 1986

Issue 2 - December 1989

Issue 2.1 December 1993

Issue 3 - March 2001 - Specification renamed as DPNSS[188]

1 GENERAL

- 1.1** This Section details the signalling requirements of DPNSS 1 for the Call Back When Next Used Supplementary Service.
- 1.2** Subsection 2 details the service within DPNSS 1.
- 1.3** Subsection 3 shows the Compliance.
- 1.4** The description is given in the form of Message Sequence Diagrams (MSDs) followed by explanatory text.
- 1.5** The text is referenced from MSDs at appropriate points in the sequences.
- 1.6** Message contents for successful calls are shown in MSDs. Messages and their contents for alternative sequences (eg for unsuccessful calls) are detailed in the text.
- 1.7** Coding of the contents of messages is given in SECTION 4.

2 CALL BACK WHEN NEXT USED WITHIN DPNSS 1

2.1 DEFINITION

The Call Back When Next Used Supplementary Service offers a user who meets no reply the possibility of having the call completed automatically when the called extension becomes free after having been used.

2.2 DESCRIPTION

When it becomes evident that there will be no reply from the called extension, the calling extension user may, by means of appropriate control procedures, clear down the call and request Call Back When Next Used (CBWNU). A Virtual Call is made to the called extension's PBX in order to register CBWNU. The next time the called extension is used (ie goes off-hook or equivalent) the registered request is converted to a Call Back When Free (CBWF) request. In due course the Free Notification and Call Set Up sequences of the CBWF service are used to complete the call. The CBWF cancellation sequence may be used to cancel a CBWNU request.

If more than one CBWNU request has been registered against the called extension, they are all converted to CBWF requests when the extension is next used; the Free Notifications are handled serially, as for the CBWF service.

2.3 OUTLINE OF OPERATION

This facility is implemented using the following separate signalling sequences:

- CBWNU Request (Paragraph 2.3.1 of this Section);
- CBWF Free Notification (SECTION 9, Paragraph 2.3.2);
- CBWF Call Set Up (SECTION 9, Paragraph 2.3.3);
- CBWF Cancel (SECTION 9, Paragraph 2.3.4).

2.3.1 CBWNU REQUEST

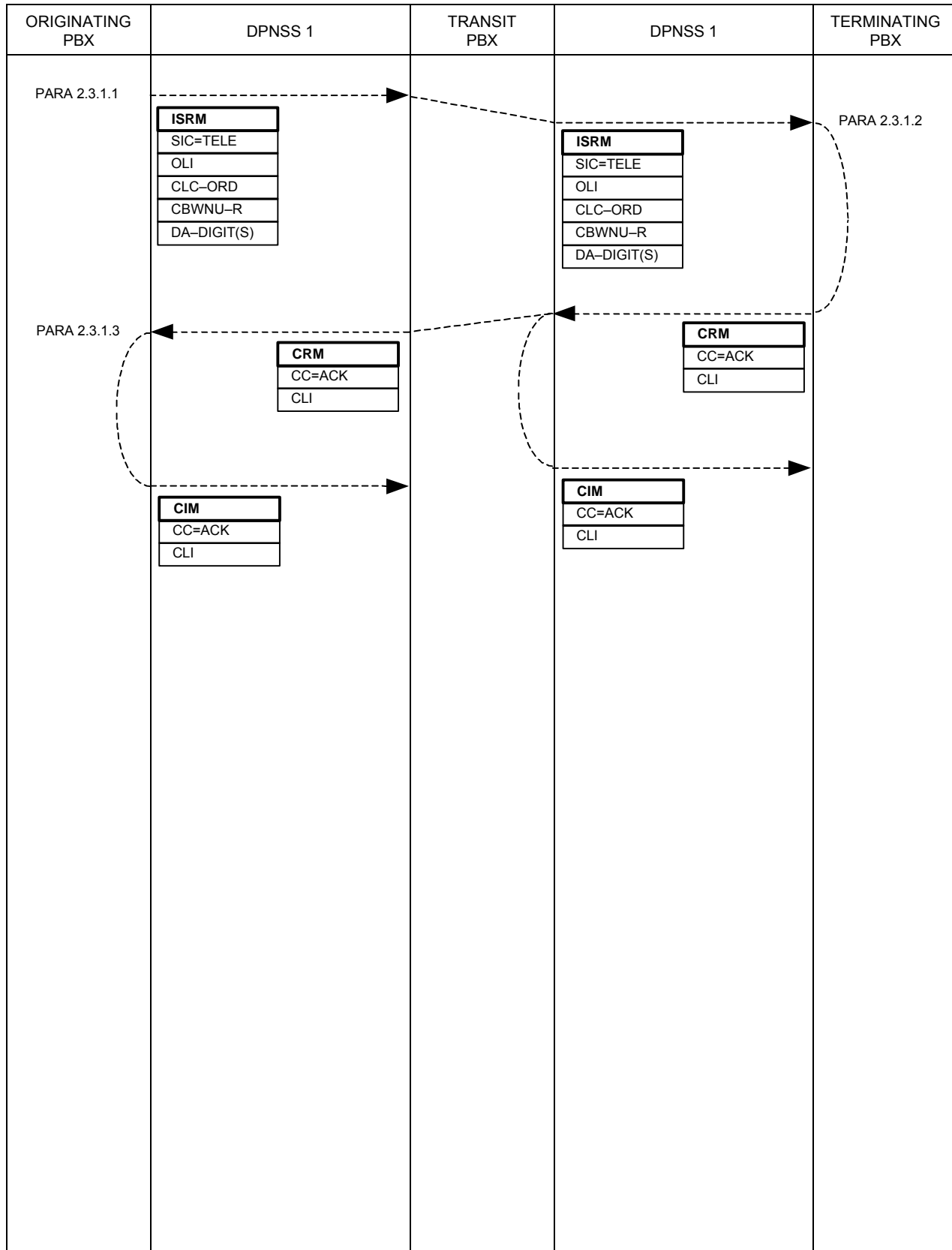

2.3.1.1 An extension user, on failing to receive a reply from another extension, may make a CBWNU request. It may be necessary for the user to clear the existing call and then make the CBWNU request within a certain period.

Alternatively, if the request is made without clearing the existing call, the call shall be cleared automatically before proceeding with the request.

If the request is valid the Originating PBX shall select a Virtual Channel and send an ISRM containing SIC=TELE, OLI, CLC-ORD, CBWNU-Request (CBWNU-R) and the Destination Address.

2.3.1.2 The CBWNU request shall be validated by the Terminating PBX and if the request is acceptable the Originating Line Identity shall be stored against the called extension, together with an indication that it is the called extension in a CBWNU call. The call shall be cleared by sending a CRM, containing Clearing Cause: ACK and the CLI of the called extension, to the Originating PBX.

A registration timeout of 492 ± 8 minutes shall be started to guard against the request being neither satisfied nor cancelled. If the timeout matures the Terminating PBX shall assume the request to have been cancelled and delete the request from its memory.

The next time the called extension is used (ie goes off-hook or equivalent), the Terminating PBX shall convert the CBWNU request to a CBWF request. The registration timeout, however, shall continue to run as for the CBWNU request.

If the called extension is already in use when the CBWNU request is validated, the CBWNU request shall be converted to a CBWF request immediately after sending the CRM containing Clearing Cause: ACK.

Once the request has been converted to CBWF, the procedures of SECTION 9 paragraph 2.3.2.1 onwards shall apply.

Note that a CBWF Cancel request may be received before the CBWNU request is converted to a CBWF request. If so the CBWNU request shall be cancelled.

If the request is unacceptable, a CRM containing one of the following Clearing Causes shall be returned to the Originating PBX:

- Called extension is barred CBWNU requests: SU
- Terminating PBX is not able to accept the request at present (eg queue is full): STU

2.3.1.3 On receipt of a CRM containing Clearing Cause: ACK the Originating PBX shall store the CLI against the calling extension, together with an indication that it is the calling extension in a CBWNU call. A confirmation indication should be given to the calling extension and a CIM shall be returned in response to the CRM.

A registration timeout of maximum value 480 minutes (suggested value 180 minutes) shall be started to guard against the request being neither satisfied nor cancelled.

The Originating PBX shall then behave as for Call Back When Free as described in SECTION 9 paragraph 2.3.2.2 onwards (by awaiting Free Notification) except that the registration timeout shall continue to run as for the CBWNU request.

If the calling user cancels the CBWNU request, or if the registration timeout matures, the Originating PBX shall initiate the CBWF Cancel procedure.

If the received CRM has a Clearing Cause other than ACK an appropriate indication should be given to the calling extension.

3 COMPLIANCE

The Call Back When Next Used Supplementary Service is an optional part of DPNSS1 and its provision on a PBX is a matter for negotiation between a customer and his supplier (see FOREWORD in SECTION 0 of this specification). This Subsection may be used as an aid to those negotiations.

NOTE: Whilst the provision of this Supplementary Service is optional, if it is provided compliance with certain features of the service becomes mandatory.

Compliance with the service is considered in terms of the function(s) to be performed by the PBX, ie Transit, End or Branching and the extent to which extensions on the PBX can request the service.

The options available are given in TABLE 1. This table should be completed by a manufacturer to indicate PBX capability and by a purchaser to indicate PBX requirements.

TABLES 2, to 4 indicate the features that are required/provided at each PBX. The pre-printed "YES" indicates that the feature is a mandatory part of the service for that PBX function.

TABLE 1

PBX FUNCTION		APPLICABLE TABLE
PBX with operators or extensions, some of which can request the service		TABLES 2 & 3
PBX with operators or extensions, none of which can request the service		TABLE 2
Transit PBX		TABLE 4

TABLE 2

COMPLIANCE TABLE FOR A PBX WITH OPERATORS OR EXTENSIONS IN A NETWORK THAT SUPPORTS CALL BACK WHEN NEXT USED		
SERVICE VARIANT		COMMENT
Able to accept a Call Back When Next Used - Request from another PBX and convert it to a Call Back When Free - Request when the called extension is next used?	YES	

TABLE 3

COMPLIANCE TABLE FOR A PBX WITH OPERATORS OR EXTENSIONS THAT ARE ABLE TO REQUEST CALL BACK WHEN NEXT USED		
SERVICE VARIANT		COMMENT
Able to request Call Back When Next Used to another PBX?	YES	

TABLE 4

COMPLIANCE TABLE FOR A TRANSIT PBX IN A NETWORK THAT SUPPORTS CALL BACK WHEN NEXT USED		
SERVICE VARIANT		COMMENT
Able to act as a Transit for Call Back When Next Used - Requests? (Virtual Call)	YES	Inherent DPNSS1 Capability

DIGITAL PRIVATE NETWORK SIGNALLING SYSTEM NO 1 (DPNSS 1)

SECTION 32 - SUPPLEMENTARY SERVICE: DO NOT DISTURB

CONTENTS

1	GENERAL	Page 2
2	DO NOT DISTURB WITHIN DPNSS 1	Page 3
	2.1 DEFINITION.....	Page 3
	2.2 DESCRIPTION.....	Page 3
	2.3 OUTLINE OF OPERATION.....	Page 3
	2.3.1 Call Encounters Do Not Disturb.....	Page 4
	2.3.2 Do Not Disturb Override.....	Page 6
3	COMPLIANCE	Page 8

HISTORY

Issue 1 - March 1986

Issue 2 - December 1989

Issue 3 - March 2001 - Specification renamed as DPNSS[188]
 - State of Destination Qualifier Parameter
 added

1 GENERAL

- 1.1** This Section details the signalling requirements of DPNSS 1 for the Do Not Disturb Supplementary Service.
- 1.2** Subsection 2 details the service within DPNSS 1.
- 1.3** Subsection 3 shows the Compliance.
- 1.4** The description is given in the form of Message Sequence Diagrams (MSDs) followed by explanatory text.
- 1.5** The text is referenced from MSDs at appropriate points in the sequences.
- 1.6** Message contents for successful calls are shown in MSDs. Messages and their contents for alternative sequences (eg for unsuccessful calls) are detailed in the text.
- 1.7** Coding of the contents of messages is given in SECTION 4.

2 DO NOT DISTURB SERVICE WITHIN DPNSS 1

2.1 DEFINITION

The Do Not Disturb Supplementary Service offers the possibility of giving a busy indication to callers when an extension user wishes not to be disturbed.

2.2 DESCRIPTION

Certain extension users may have the capability of invoking a Do Not Disturb (DND) condition. Any incoming call to an extension with the DND condition invoked will receive a busy indication unless the caller has requested DND Override. When the user removes the DND condition the extension will again be able to receive calls.

2.3 OUTLINE OF OPERATION

This facility is implemented using the following separate signalling sequences.

2.3.1 Call Encounters DND.

2.3.2 DND Override.

2.3.1 CALL ENCOUNTERS DND

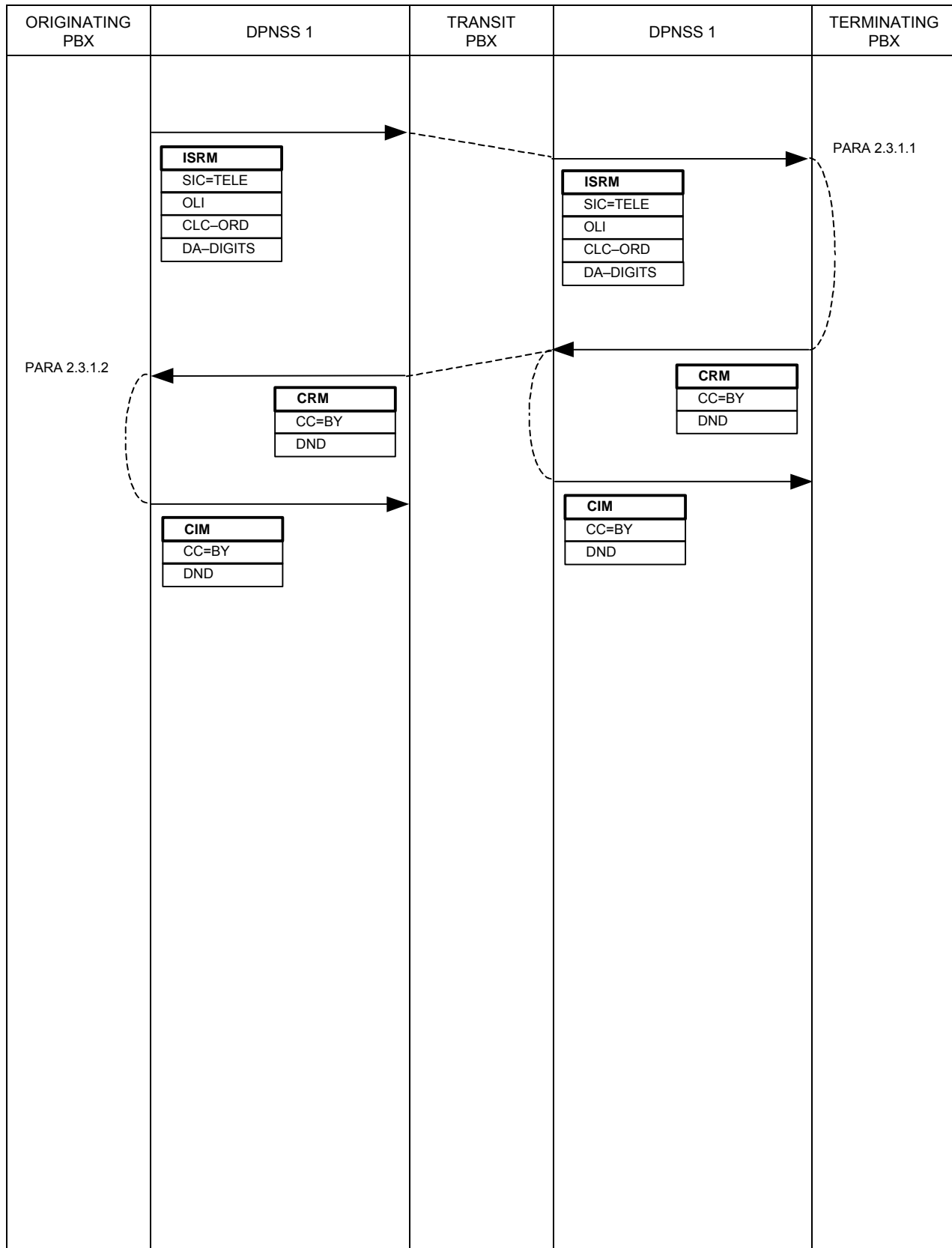

2.3.1.1 When the Destination Address in an ISRM indicates an extension with the DND condition invoked, the call is cleared by sending a CRM containing the Clearing Cause: BY and string DND. The first Parameter of String DND indicates whether the extension is also engaged in a call. A second optional Parameter indicates whether the first Parameter value is assumed. This is used when the terminating PBX is only able to provide an assumed value (eg when interworking with a signalling system that does not provide information as to whether the extension is engaged in a call).

2.3.1.2 The presence of string DND in a CRM containing the Clearing Cause: BY may be used to give a special indication to the caller.

2.3.2 DND OVERRIDE

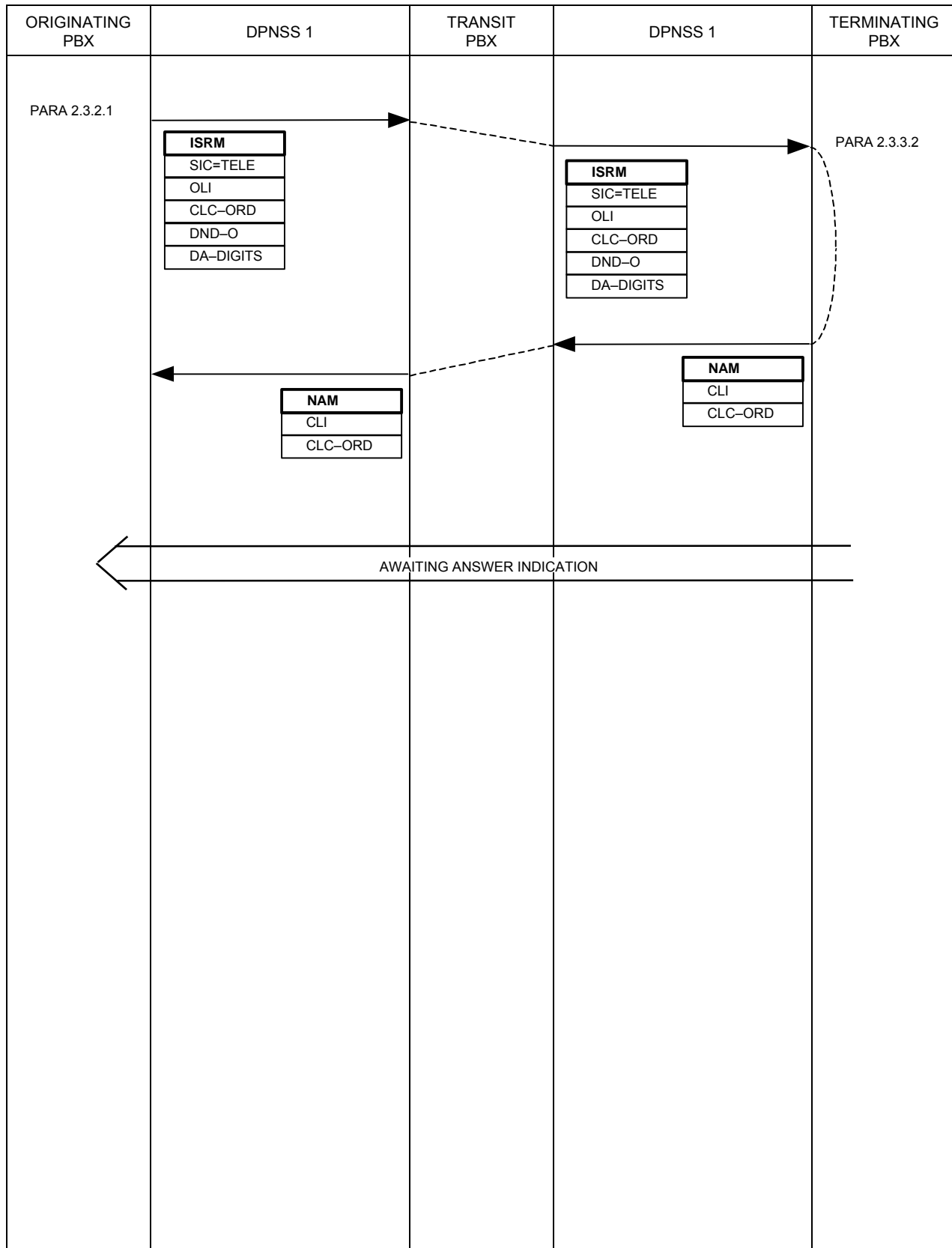

2.3.2.1 An Originating PBX includes string DND Override (DND-0) in an ISRM if the calling extension user (or operator) with the necessary Class of Service has indicated that DND is to be overridden.

2.3.2.2 When the Destination Address in an ISRM indicates an extension with the DND condition invoked, the presence of string DND-0 causes DND to be overridden. If the extension is free it is called and a NAM is returned. If the extension is busy the call is cleared by returning a CRM containing the Clearing Cause: BY without string DND.

3 COMPLIANCE

The Do Not Disturb Supplementary Service is an optional part of DPNSS1 and its provision on a PBX is a matter for negotiation between a customer and his supplier (see FOREWORD in SECTION 0 of this specification). This Subsection may be used as an aid in those negotiations.

NOTE: Whilst the provision of this Supplementary Service is optional, if it is provided compliance with certain features of the service becomes mandatory.

Compliance with the service is considered in terms of the function(s) to be performed by the PBX, ie Transit, End or Branching and the extent to which extensions on the PBX can request the service.

The options available are given in TABLE 1. This table should be completed by a manufacturer to indicate PBX capability and by a purchaser to indicate PBX requirements.

TABLES 2 to 4 indicate the features that are required/provided at each PBX. The pre-printed "YES" indicates that the feature is a mandatory part of the service for that PBX function.

TABLE 1

PBX FUNCTION		APPLICABLE TABLE
PBX with extensions, some of which can have a DND condition invoked		TABLES 2 & 3
PBX with extensions or operators, none of which can have a DND condition invoked		TABLE 2
Transit PBX		TABLE 4

TABLE 2

COMPLIANCE TABLE FOR A PBX WITH EXTENSIONS OR OPERATORS IN A NETWORK THAT SUPPORTS DND		
SERVICE VARIANT		COMMENT
Able as an Outgoing PBX to respond correctly when it receives a DND indication from a called extension on another PBX?	YES	
Able to request override of DND when it is encountered on another PBX?		

TABLE 3

COMPLIANCE TABLE FOR A PBX WITH EXTENSIONS THAT ARE CAPABLE OF HAVING A DND CONDITION INVOKED		
SERVICE VARIANT		COMMENT
Able to inform another PBX that an incoming call has encountered an extension with DND invoked?	YES	
Able to override DND when requested to do so by other PBXs?	YES	

TABLE 4

COMPLIANCE TABLE FOR A TRANSIT PBX IN A NETWORK THAT SUPPORTS DND		
SERVICE VARIANT		COMMENT
Able to act as a Transit for calls that encounter DND or request override of DND?	YES	Inherent DPNSS 1 capability

DIGITAL PRIVATE NETWORK SIGNALLING SYSTEM NO 1 (DPNSS 1)

SECTION 33 - SUPPLEMENTARY SERVICE: REMOTE REGISTRATION AND CANCELLATION OF DIVERSION

CONTENTS

1	GENERAL	Page 2
2	REMOTE REGISTRATION AND CANCELLATION OF DIVERSION WITHIN DPNSS 1	Page 3
2.1	DEFINITION.....	Page 3
2.2	DESCRIPTION.....	Page 3
2.3	OUTLINE OF OPERATION.....	Page 4
2.3.1	Remote Set Diversion.....	Page 5
2.3.2	Remote Cancel Diversion.....	Page 7
2.3.3	Remote Set or Cancel Diversion Using a Password.....	Page 9
3	COMPLIANCE	Page 10

HISTORY

Issue 1 - March 1986
Issue 2 - December 1989
Issue 2.1 - December 1993
Issue 3 - January 1995

Issue 4 - March 2001 - Specification renamed as DPNSS[188]

1 GENERAL

- 1.1** This Section details the signalling requirements of DPNSS 1 for the Remote Registration and Cancellation of Diversion Service.
- 1.2** Subsection 2 details the service within DPNSS 1.
- 1.3** Subsection 3 shows the Compliance.
- 1.4** The description is given in the form of Message Sequence Diagrams (MSDs) followed by explanatory text.
- 1.5** The text is referenced from MSDs at appropriate points in the sequences.
- 1.6** Message contents for successful calls are shown in MSDs. Messages and their contents for alternative sequences (eg for unsuccessful calls) are detailed in the text.
- 1.7** Coding of the contents of messages is given in SECTION 4.

2 REMOTE REGISTRATION AND CANCELLATION OF DIVERSION SERVICE WITHIN DPNSS 1

2.1 DEFINITION

The Remote Registration and Cancellation of Diversion Supplementary Service allows an extension or operator on one PBX to set or cancel Diversion at an extension on another PBX in the DPNSS 1 network.

2.2 DESCRIPTION

SECTION 11 of this specification specifies three types of Diversion: Immediate, On Busy, and On No-Reply. DPNSS 1 signalling is also required if Diversion is to be registered or cancelled from a remote PBX.

A type of Diversion which is not specified in SECTION 11 is Combined Diversion (see NOTE at the end of this paragraph). When Combined Diversion is registered from the Diverting Extension, no extra DPNSS 1 signalling is required and SECTION 11 fully covers the subsequent operation. However, when Combined Diversion is registered or cancelled remotely, extra DPNSS 1 signalling is required and is described in this Section.

SECTION 11 specifies cancellation from the nominated extension and re-registration (Diversion Immediate only) from an existing nominated extension (Follow Me). This Remote Registration and Cancellation of Diversion service allows any extension or operator to perform registration and cancellation. Uses for this service include the following:

- i. To enable an operator or privileged extension user to register or cancel Diversion on behalf of an unattended extension or one which does not have the necessary Class of Service for the operation to be performed locally.
- ii. To enable a user who is absent from his normal location to register or cancel Diversion. The extension used to perform registration may also be the one which is to be nominated to receive calls.

In addition this service permits an operator or privileged extension to cancel any or all types of Diversion for all extensions on a PBX.

Attention is drawn to the security aspects of this service. Only operators or privileged extensions should be given the ability to make general use of this service. To enable a user to use an ordinary extension in order to register or cancel Diversion on his own extension, provision is made for the user to enter a password for checking against the password registered at his own extension.

NOTE: Combined Diversion is a type of Diversion which, when registered against an extension, causes an incoming call to that extension to be diverted if either of the conditions for Diversion On No-Reply or Diversion On Busy apply. A common Nominated Number is used for the diverted call whichever of the two conditions is encountered.

Some PBXs allow all types of Diversion to be registered simultaneously; any conflicts being resolved by treating the registrations in a hierarchical order. The hierarchical order in which simultaneously registered diversions are dealt with is a PBX implementation dependent matter.

One hierarchical scheme could, for example, be such that Diversion Immediate would override all other types and Combined Diversion would override separately registered Diversion On Busy and/or Diversion On No-Reply. With this scheme Combined Diversion could be invoked to provide an alternative answering point for incoming calls during the working day, when the wanted party is not immediately available to take a call. Additionally the Combined Diversion could be used temporarily to override a previously registered Diversion On No-Reply. Thus if Combined Diversion were to be cancelled at the end of each working day, calls would revert to being diverted On No-Reply, to an answering point different from the daytime alternative.

2.3 OUTLINE OF OPERATION

This facility is implemented using the following separate signalling sequences:

- 2.3.1 Remote Set Diversion.
- 2.3.2 Remote Cancel Diversion.

2.3.1 REMOTE SET DIVERSION

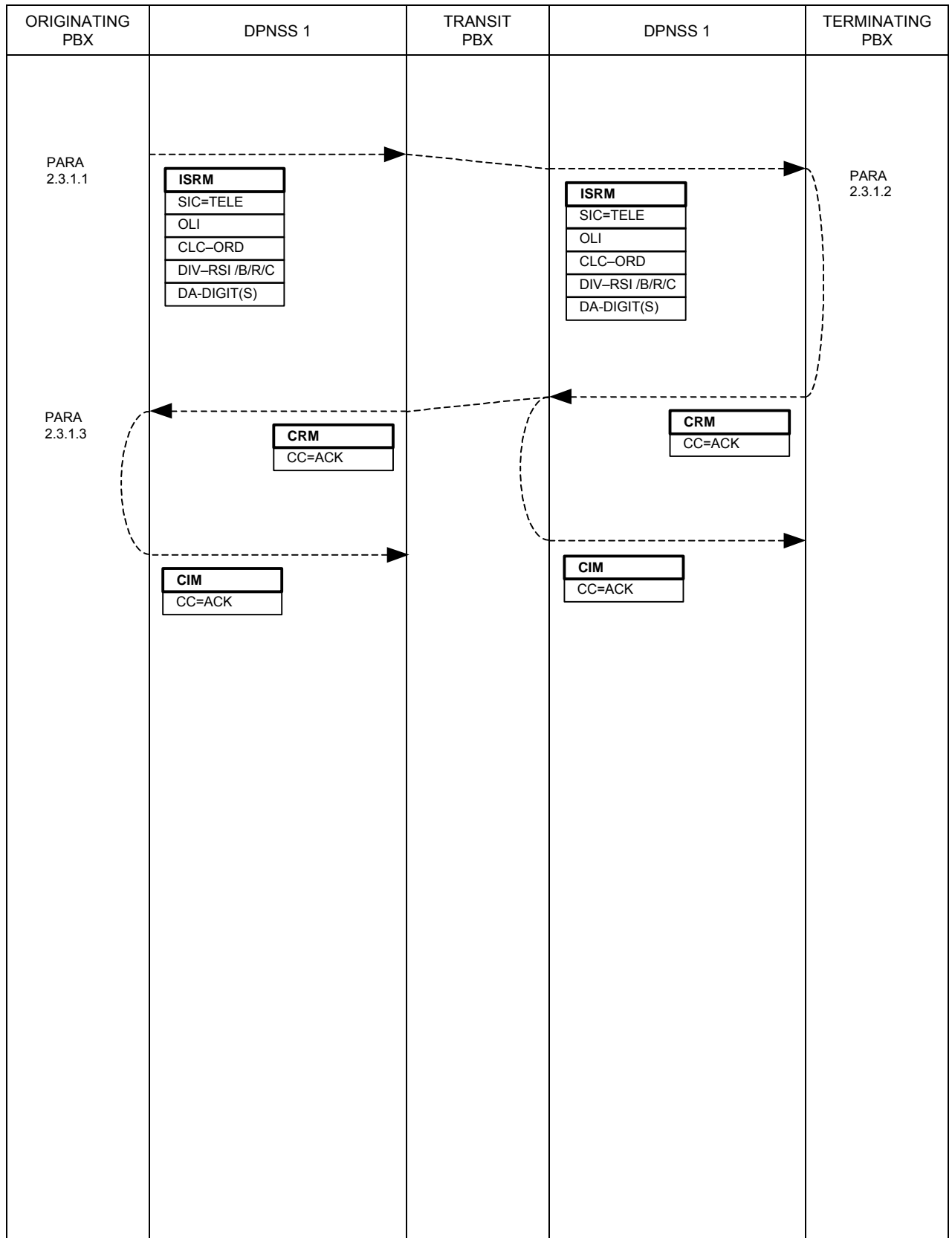

2.3.1.1 A request from an extension (or operator) to register Diversion on a remote extension shall be validated by the Originating PBX; this shall include checking that the extension has the necessary privilege. If the request is valid a call is made over a Virtual Channel using the remote extension number as the Destination Address. Included in the ISRM shall be the OLI, the CLC and the appropriate Set Diversion String:

DIV-RSI - Remote Set Diversion Immediate

DIV-RSB - Remote Set Diversion on Busy

DIV-RSR - Remote Set Diversion on No-Reply

DIV-RSC - Remote Set Combined Diversion

In each case the String Parameter is the nominated extension number. The Parameter may be omitted if there is already a default nominated extension number registered against the called extension and Diversion has just to be activated.

2.3.1.2 On receipt of an ISRM containing a Remote Set Diversion String the Terminating PBX shall validate the Diversion Request. The OLI and CLC may be taken into account.

If the nominated extension is on a different PBX from the diverting extension the Diversion Registration procedure of SECTION 11, Paragraph 2.3.1 shall be used to validate the nominated extension. However, if the nominated number is the same as that of the requesting extension (as indicated by the OLI) this procedure may be omitted.

If there is no nominated extension number in the Set Diversion String a default may be used.

If the request is acceptable the Terminating PBX shall register Diversion on the addressed extension (cancelling any previous Diversion of the same type) and shall clear the call by sending a CRM containing Clearing Cause: ACK.

If for any reason Diversion cannot be set, Clearing Cause: SU shall be used.

2.3.1.3 On receipt of a CRM containing Clearing Cause: ACK, a confirmation indication shall be given to the requesting party.

Receipt of a CRM containing a Clearing Cause other than ACK indicates that the request has failed. An appropriate indication shall be given to the requesting party.

2.3.2 REMOTE CANCEL DIVERSION

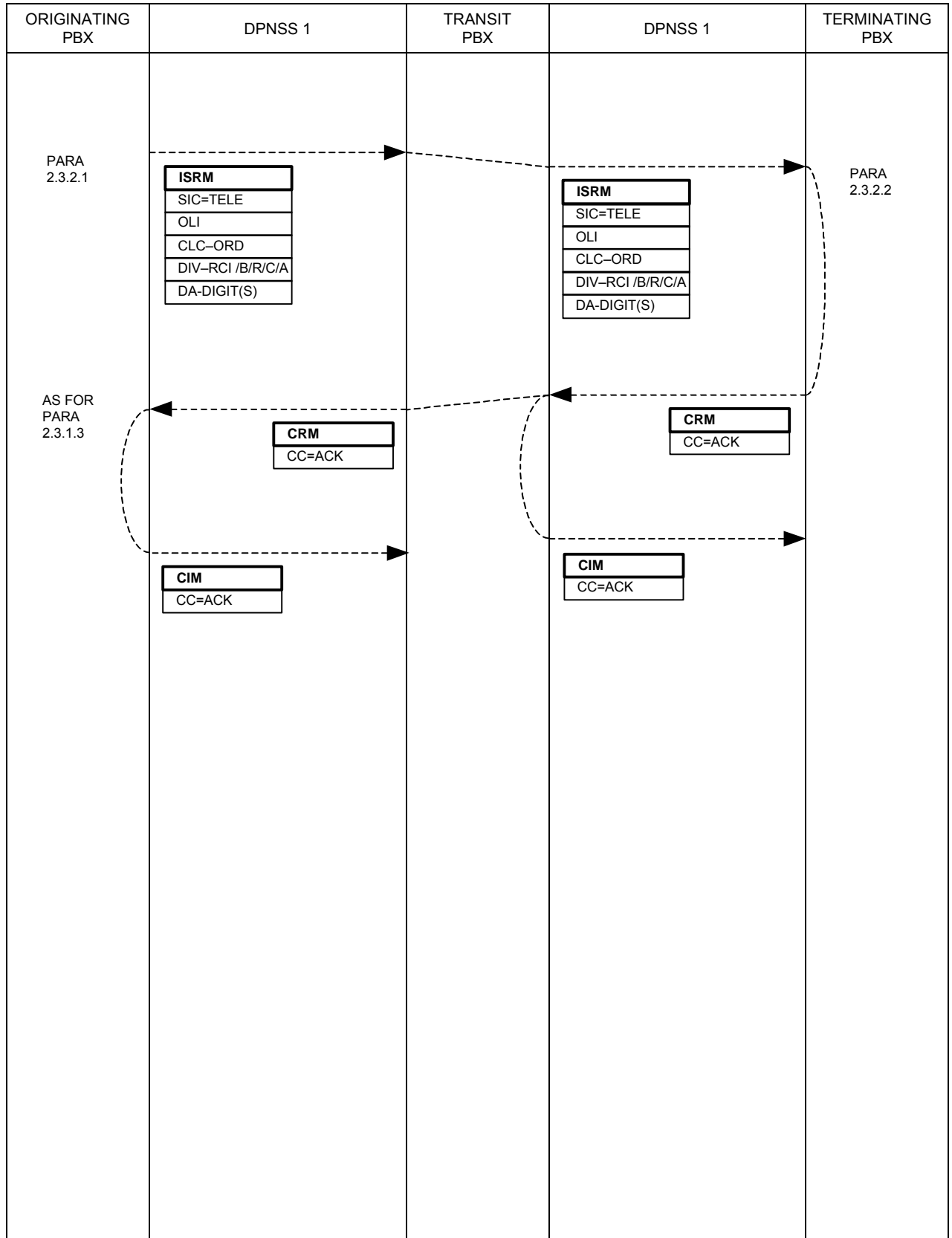

2.3.2.1 A request from an extension (or operator) to cancel Diversion on a remote extension shall be validated by the Originating PBX; this shall include checking that the extension has the necessary privilege. If the request is valid a call shall be made over a Virtual Channel using the remote extension number as the Destination Address.

Alternatively, if all extensions on a PBX are to have their diversions cancelled, the Destination Address shall identify only the PBX. Included in the ISRM shall be the OLI, the CLC and the appropriate Cancel Diversion String:

DIV-RCI - Remote Cancel Diversion Immediate

DIV-RCB - Remote Cancel Diversion on Busy

DIV-RCR - Remote Cancel Diversion on No-Reply

DIV-RCC - Remote Cancel Combined Diversion

DIV-RCA - Remote Cancel All Diversions

2.3.2.2 On receipt of an ISRM containing a Remote Cancel Diversion String, the Terminating PBX shall check whether cancellation is permitted for the specific extension addressed or for all extensions. The OLI and CLC may be taken into account.

If the request is acceptable, the Terminating PBX shall cancel Diversion and clear the call by sending a CRM containing the Clearing Cause: ACK.

If cancellation is not permitted, the call shall be cleared by sending a CRM containing the Clearing Cause: SU.

If a particular extension is addressed and that extension does not have any diversions to be cancelled, Clearing Clause: FNR shall be used.

2.3.3 Remote Set or Cancel Diversion Using a Password

For a user to be able to register or cancel Diversion on his own extension from anywhere in the network could imply that all extensions in the network have the privilege to invoke this service. However, it may be undesirable to give all users the ability to register or cancel Diversions on any extension in the network. The password option allows registration or cancellation to be carried out from extensions which do not otherwise have the necessary privilege, provided that a password associated with the target extension is used.

The String PASSW shall always be included in the ISRM in respect of remote requests to set or cancel diversion from non privileged extensions. The inclusion of String PASSW in the ISRM in respect of remote requests from privileged extensions is not necessary.

In the case of remote requests from non privileged extensions, either the Parameter to PASSW shall be derived from a password entered at the requesting extension, or, when no password is entered, it shall be a default inserted by the PBX.

If a password is entered at a privileged extension, although not necessary, it is recommended that it be accepted and included in the ISRM as the Parameter to String PASSW.

Passwords cannot be used when cancelling Diversion on behalf of all extensions on a PBX; this may only be performed from privileged extensions.

On receipt of an ISRM requesting Remote Registration or Cancellation of Diversion and containing String PASSW, if there is a password registered against the called extension the two passwords shall be compared and if they differ the request shall be rejected by sending a CRM containing the Clearing Cause: SU. If there is no password registered against the called extension String PASSW shall be ignored.

If there is a password registered against the called extension but String PASSW is absent it can be assumed that the calling party has sufficient privilege to request the service without entering a password (ie that the privileged capability was validated at the Originating PBX).

3 COMPLIANCE

The Remote Registration and Cancellation of Diversion Supplementary Service is an optional part of DPNSS1 and its provision on a PBX is a matter for negotiation between a customer and his supplier (see FOREWORD in SECTION 0 of this specification). This Subsection may be used as an aid to those negotiations.

NOTE: Whilst the provision of this Supplementary Service is optional, if it is provided compliance with certain features of the service becomes mandatory.

Compliance with the service is considered in terms of: the function(s) to be performed by the PBX, ie Transit, End or Branching; the extent to which extensions on the PBX can request the service; the extent to which operators or extensions can be the target of the service, and whether the use of a password is required.

The options available are given in TABLE 1. This table should be completed by a manufacturer to indicate PBX capability and by a purchaser to indicate PBX requirements.

TABLES 2 to 4 indicate the functions that are required/provided at each PBX. The pre-printed "YES" indicates that the feature is a mandatory part of the service for that PBX function.

TABLE 1

PBX FUNCTION		APPLICABLE TABLE
PBX with operators or extensions, some of which can have diversion registered remotely.		TABLE 2
PBX with extensions, some of which can register diversion at remote extensions		TABLE 3
Transit PBX		TABLE 4

TABLE 2

COMPLIANCE TABLES FOR A PBX WITH EXTENSIONS THAT ARE CAPABLE OF HAVING DIVERSION REGISTERED REMOTELY		
SERVICE VARIANT		COMMENT
Able to accept requests to set Diversion Immediate for an extension?	YES	
Able to accept requests to cancel Diversion Immediate for an extension?	YES	
Able to accept requests to cancel Diversion Immediate for all extensions?		
Able to accept requests to set and cancel Diversion On Busy for an extension?		
Able to accept requests to cancel Diversion On Busy for all extensions?		
Able to accept requests to set and cancel Diversion On No-Reply for an extension?		
Able to accept requests to cancel Diversion On No-Reply for all extensions?		
Able to accept requests to set and cancel Combined Diversion for an extension?		
Able to accept requests to cancel Combined Diversion for all extensions?		
Able to accept requests to cancel all Diversions for an extension?		
Able to accept requests to cancel all Diversions for all extensions?		
Able to validate a received password?		

TABLE 3

COMPLIANCE TABLE FOR A PBX WITH EXTENSIONS THAT ARE CAPABLE OF REGISTERING DIVERSION AT REMOTE EXTENSIONS		
SERVICE VARIANT		COMMENT
Able to initiate requests to set Diversion Immediate for an extension?	YES	
Able to initiate requests to cancel Diversion Immediate for an extension?		
Able to initiate requests to cancel Diversion Immediate for all extensions?		
Able to initiate requests to set and cancel Diversion On Busy for an extension?		
Able to initiate requests to cancel Diversion On Busy for all extensions?		
Able to initiate requests to set and cancel Diversion On No-Reply for an extension?		
Able to initiate requests to cancel Diversion On No-Reply for all extensions?		
Able to initiate requests to set and cancel Combined Diversion for an extension?		
Able to initiate requests to cancel Combined Diversion for all extensions?		
Able to initiate requests to cancel all Diversions for an extension?		
Able to initiate requests to cancel all Diversions for all extensions?		
Able to send a password?		

TABLE 4

COMPLIANCE TABLE FOR A TRANSIT PBX IN A NETWORK THAT SUPPORTS REMOTE REGISTRATION OF DIVERSION		
SERVICE VARIANT		COMMENT
Able to act as a Transit for Remote Set and Cancel Diversion requests with and without associated passwords (Virtual Call)?	YES	Inherent DPNSS 1 capability

DIGITAL PRIVATE NETWORK SIGNALLING SYSTEM NO 1 (DPNSS 1)

SECTION 34 - SUPPLEMENTARY SERVICE: REMOTE REGISTRATION OF DO NOT DISTURB

CONTENTS

1	GENERAL	Page 2
2	REMOTE REGISTRATION OF DO NOT DISTURB WITHIN DPNSS 1 ..	Page 3
	2.1 DEFINITION.....	Page 3
	2.2 DESCRIPTION.....	Page 3
	2.3 OUTLINE OF OPERATION.....	Page 3
	2.3.1 Remote Control of Do Not Disturb.....	Page 4
3	COMPLIANCE	Page 6

HISTORY

Issue 1 - March 1986

Issue 2 - December 1989

Issue 3 - March 2001 - Specification renamed as DPNSS[188]

1 GENERAL

- 1.1** This Section details the signalling requirements of DPNSS 1 for the Remote Registration of Do Not Disturb Supplementary Service.
- 1.2** Subsection 2 details the service within DPNSS 1.
- 1.3** Subsection 3 shows the Compliance.
- 1.4** The description is given in the form of Message Sequence Diagrams (MSDs) followed by explanatory text.
- 1.5** The text is referenced from MSDs at appropriate points in the sequences.
- 1.6** Message contents for successful calls are shown in MSDs. Messages and their contents for alternative sequences (eg for unsuccessful calls) are detailed in the text.
- 1.7** Coding of the contents of messages is given in SECTION 4.

**2 REMOTE REGISTRATION OF DO NOT DISTURB SUPPLEMENTARY SERVICE
WITHIN DPNSS 1**

2.1 DEFINITION

The Remote Registration of Do Not Disturb Supplementary Service offers the possibility of an operator or a privileged extension invoking or removing the Do Not Disturb (DND) condition on extensions.

2.2 DESCRIPTION

SECTION 32 of this specification specifies the Do Not Disturb Supplementary Service.

The Remote Registration of Do Not Disturb Supplementary Service permits an operator or a privileged extension to set or cancel the Do Not Disturb condition on behalf of an extension on another PBX. This is particularly useful for extensions which do not have the necessary Class of Service for the user to perform the operation.

2.3 OUTLINE OF OPERATION

This facility is implemented using the following signalling sequence:

2.3.1 Remote Control of DND.

2.3.1 REMOTE CONTROL OF DND

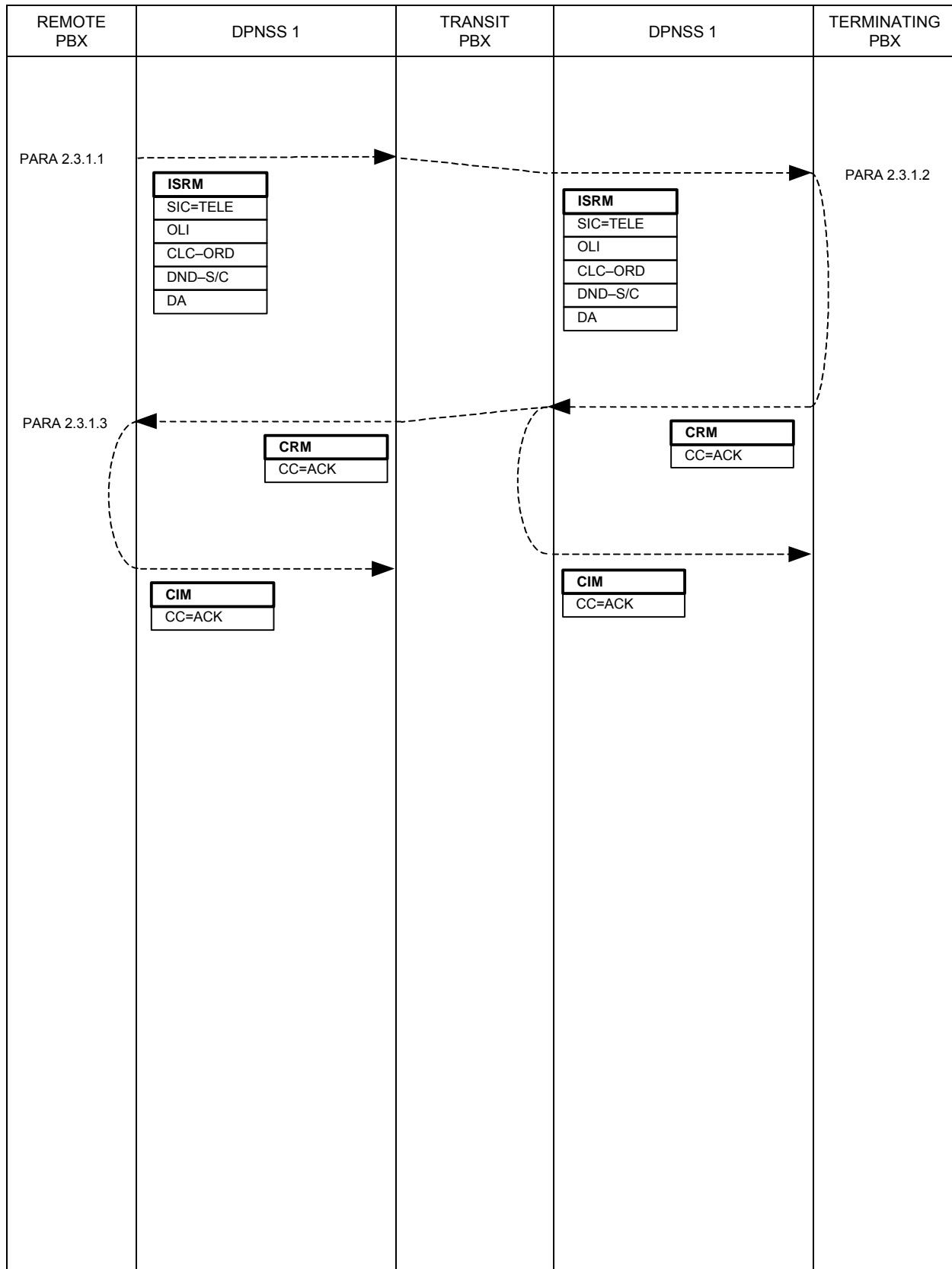

2.3.1.1 When a privileged extension (or operator) requests the setting or cancelling of DND on an extension, a call shall be made over a Virtual Channel using the extension number as the Destination Address and including the String DND-Set (DND-S) or DND-Clear (DND-C) in the ISRM.

NOTE: The Originating PBX shall ensure that the privileged extension is permitted to make the request.

2.3.1.2 The Terminating PBX shall set or cancel DND on the addressed extension, as appropriate, and clear the call by sending a CRM containing Clearing Cause: Acknowledge (ACK). If for any reason the extension cannot have DND set a Clearing Cause: Reject (REJ) shall be used. Note that the fact that an extension does not itself have the Class of Service necessary for the user to invoke DND, will not necessarily prevent an operator or privileged extension from invoking DND on that extension.

2.3.1.3 On receipt of a CRM containing Clearing Cause: ACK, a confirmation indication shall be given to the requesting party.

Receipt of a CRM containing a Clearing Cause other than ACK indicates that the request has failed. An appropriate indication shall be given to the requesting party.

3 COMPLIANCE

The Remote Registration of Do Not Disturb Supplementary Service is an optional part of DPNSS 1 and its provision on a PBX is a matter for negotiation between a customer and his supplier (see FOREWORD in SECTION 0 of this specification). This Subsection may be used as an aid to those negotiations.

NOTE: Whilst the provision of this Supplementary Service is optional, if it is provided compliance with certain features of the service becomes mandatory.

Compliance with the service is considered in terms of the function(s) to be performed by the PBX, ie Transit, End or Branching and the extent to which extensions on the PBX can request the service and to which extensions can be the target of the service.

The options available are given in TABLE 1. This table should be completed by a manufacturer to indicate PBX capability and by a purchaser to indicate PBX requirements.

TABLES 2, to 4 indicate the features that are required/provided at each PBX. The pre-printed "YES" indicates that the feature is a mandatory part of the service for that PBX function.

TABLE 1

PBX FUNCTION		APPLICABLE TABLE
PBX with extensions, some of which can have DND registered by remote extensions.		TABLE 2
PBX with operators or extensions, some of which can register DND at remote extensions.		TABLE 3
Transit PBX.		TABLE 4

TABLE 2

COMPLIANCE TABLE FOR A PBX WITH EXTENSIONS THAT ARE CAPABLE OF HAVING DND REGISTERED BY A REMOTE EXTENSION		
SERVICE VARIANT		COMMENT
Able to accept requests to set and cancel DND at an extension?	YES	

TABLE 3

COMPLIANCE TABLE FOR A PBX WITH EXTENSIONS THAT ARE CAPABLE OF REGISTERING DND AT REMOTE EXTENSIONS		
SERVICE VARIANT		COMMENT
Able to initiate requests to set and cancel DND for an extension?	YES	

TABLE 4

COMPLIANCE TABLE FOR A TRANSIT PBX IN A NETWORK THAT SUPPORTS REMOTE REGISTRATION OF DIVERSION		
SERVICE VARIANT		COMMENT
Able to act as a Transit for Remote Set and Cancel DND Requests (Virtual Call)?	YES	Inherent DPNSS 1 capability

DIGITAL PRIVATE NETWORK SIGNALLING SYSTEM NO 1 (DPNSS 1)

SECTION 35 - SERVICE: PRIORITY BREAKDOWN

CONTENTS

1	GENERAL	Page 2
2	PRIORITY BREAKDOWN WITHIN DPNSS 1	Page 3
2.1	DEFINITION.....	Page 3
2.2	DESCRIPTION.....	Page 3
2.3	OUTLINE OF OPERATION.....	Page 5
2.3.1	Call Set Up, Protection Required By the Terminating PBX.....	Page 6
2.3.2	Call Set Up, Protection Required By the Originating PBX.....	Page 8
2.3.3	Breakdown at a Busy Extension.....	Page 10
2.3.4	Breakdown after Congestion is Encountered.....	Page 12
3	COMPLIANCE	Page 14

HISTORY

Issue 1 - March 1986

Issue 2 - December 1989

Issue 3 - March 2001 - Specification renamed as DPNSS[188]

1 GENERAL

- 1.1** This Section details the signalling requirements of DPNSS 1 for the Priority Breakdown Supplementary Service.
- 1.2** Subsection 2 details the service within DPNSS 1.
- 1.3** Subsection 3 shows the Compliance.
- 1.4** The description is given in the form of Message Sequence Diagrams (MSDs) followed by explanatory text.
- 1.5** The text is referenced from MSDs at appropriate points in the sequences.
- 1.6** Message contents for successful calls are shown in MSDs. Messages and their contents for alternative sequences (eg for unsuccessful calls) are detailed in the text.
- 1.7** Coding of the contents of messages is given in SECTION 4.

2 PRIORITY BREAKDOWN WITHIN DPNSS 1

2.1 DEFINITION

Priority Breakdown offers users of selected extensions who meet congestion or busy the possibility of breaking down (an) existing connection(s) to enable their call to mature.

2.2 DESCRIPTION

A Priority Breakdown call may be requested when a user meets called extension busy or trunk congestion when trying to establish a call. In order to control the use of Priority Breakdown the signalling system allows for each call in progress to have a Breakdown Protection Level (BPL), and a call attempting to breakdown an existing call to have a Breakdown Capability Level (BCL).

The following levels are used:

BCL		BPL	
Breakdown Level	15	Total Protection	15
Breakdown Level	14	Protection Level	14
Breakdown Level	2	Protection Level	2
Breakdown Level	1	Protection Level	1
No Breakdown	0	No Protection	0

A call may be broken down only if its BPL is less than the BCL of the call requesting breakdown.

A BPL is assigned to a call at set-up time by the Originating PBX, and may optionally be increased by the Terminating PBX. The manner in which a PBX selects a BPL for a call is dependent on the design of the PBX; generally it will depend on the Class of Service (COS) of the extension, but a calling user may have the ability to request different levels on a call by call basis. The BPL of a call is signalled across the DPNSS 1 network and stored at each PBX, for use in the event of another call requesting breakdown.

The Simple Call as defined in SECTION 6 is treated as a call with the lowest level of protection (ie BPL 0) and as such would not signal its protection level. However, each exchange in a network supporting the Priority Breakdown service would store the BPL 0 by default.

A BCL is assigned to a call requesting breakdown. The manner in which a PBX selects a BCL for a call is dependent on the design of the PBX; generally it will depend on the COS of the requesting extension. The BCL is signalled across the DPNSS 1 network for use at any PBX which needs to break down an existing call.

Where breakdown is required to overcome trunk congestion and there is more than one call with a low enough BPL to be broken down, a call with the lowest BPL is chosen. If there are no calls with a low enough BPL the Breakdown Request is rejected.

Where breakdown is required in order to connect to a busy extension, if the existing call's BPL is too high the Breakdown Request is rejected.

Ideally, a PBX should support 16 BCLs and 16 BPLs. However, many current systems may not have this level of flexibility and the manufacturer may not want to modify his system. In these cases it should be possible to map the codes and restrictions of a particular system on to the 16 levels available.

Example

A system may offer Priority Breakdown in the following limited manner:

- Each call is allowed or not allowed to breakdown a call dependent upon a single bit COS indicator within the PBX.
- Each call is allowed or not allowed to be broken down dependent upon a single bit COS indicator within the PBX.

In this example the COS indicator can be mapped on to the signalling levels in the following way:

Breakdown Capability	= Breakdown Level	15
No Breakdown Capability	= Breakdown Level	0
Breakdown Allowed	= Protection Level	0
Breakdown Not Allowed	= Protection Level	15

By using these levels it is possible to interwork systems and achieve a reasonable degree of control over breakdown.

Particular networks need not make use of all the levels provided.

At the same time as sending a BPL across the network, String SFI (Supplementary Facilities Inhibited) may also be sent; this indicates to other PBXs that they are prevented from invoking Supplementary Services during the call. The means of determining whether SFI is sent is dependent on the design of the PBX.

2.3 OUTLINE OF OPERATION

The Supplementary Service comprises two main facilities:

- i. setting the protection level of the call, both by the Originating PBX and by the Terminating PBX.
- ii. breakdown of established calls, either to overcome trunk congestion or to allow connection to a busy extension.

These facilities are implemented using the following separate signalling sequences:

- 2.3.1 Call Set Up, Protection Required by the Terminating PBX.
- 2.3.2 Call Set Up, Protection Required by the Originating PBX.
- 2.3.3 Breakdown at a Busy Extension.
- 2.3.4 Breakdown after Congestion is Encountered.

2.3.1 CALL SET-UP, PROTECTION REQUIRED BY THE TERMINATING PBX

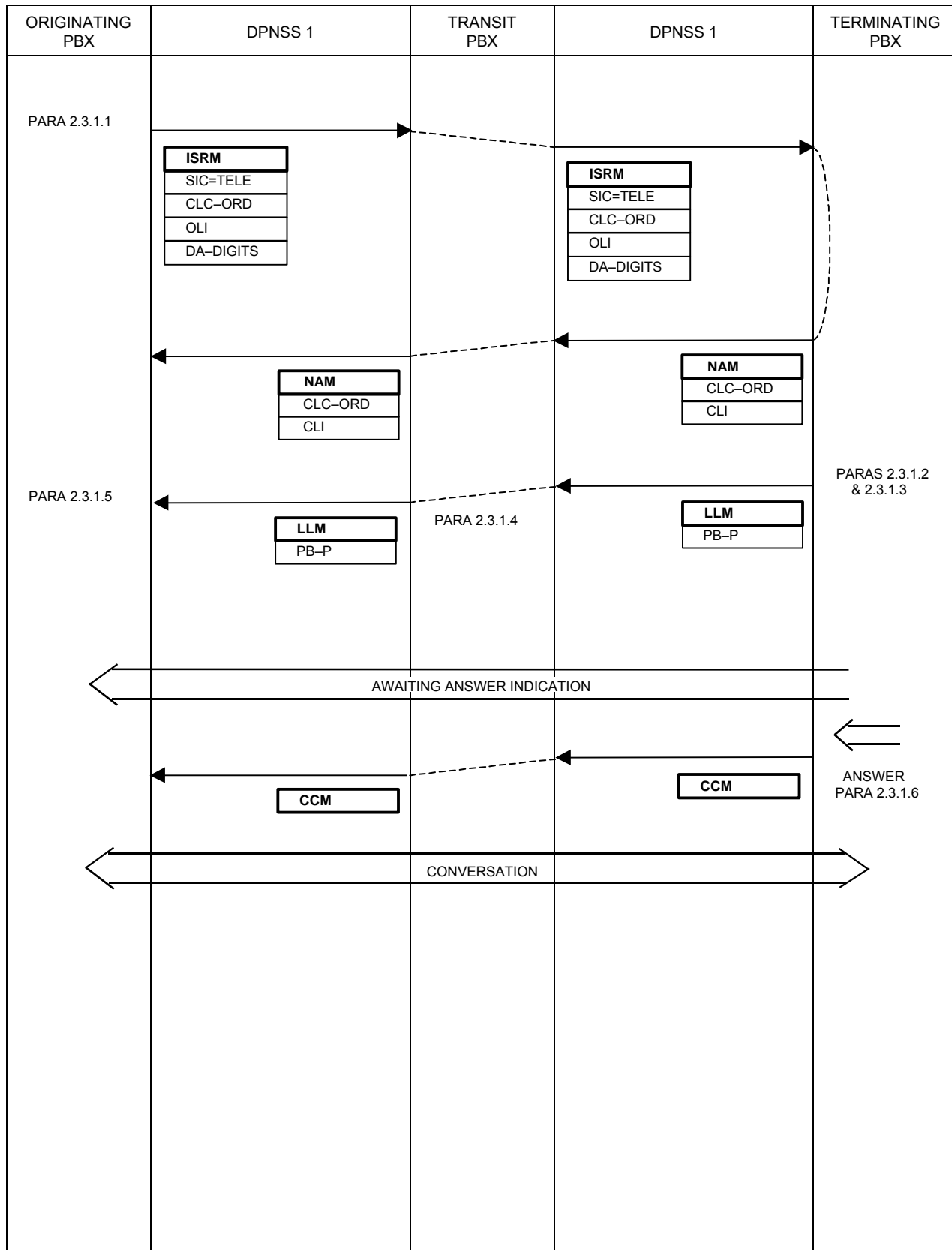

2.3.1.1 An ISRM is sent towards the Terminating PBX as for a Simple Call. Call set up for the least protected calls, ie those with a BPL of 0, shall be as for Simple Calls as detailed in SECTION 6. However, a BPL of 0 shall be stored at each PBX associated with the call.

2.3.1.2 If the extension is free and after sending the NAM, the Terminating PBX shall check if the called extension requires a BPL greater than 0.

2.3.1.3 If protection is required by the called extension, String PB-P, with the required BPL as a Parameter, shall be returned in a Link by Link Message (LLM) towards the Originating PBX. If the terminating extension requires SFI and an SFI string was not included in the ISRM, then the string SFI shall also be included in the LLM.

2.3.1.4 When the LLM is received at a Transit PBX, the BPL (and SFI, if requested) shall be stored for this call before repeating the LLM to the next PBX.

As string PB-P has a suffix indicating that it is optional, any PBX not recognising it will allow the call to continue but will return a LLM with a String IG-SNU to indicate such. This may be used by the Terminating PBX to indicate that protection was not applied.

2.3.1.5 On receipt of the LLM the Originating PBX shall store the BPL (and SFI, if requested).

2.3.1.6 The Terminating PBX may need to change the BPL either when the call is answered (eg, if the call is answered by a different extension) or, after answer, on request from the called user. After sending the CCM, the Terminating PBX shall send the new BPL in String BP-P in an LLM. Transit PBXs and the Originating PBX shall act upon the LLM as described in paragraphs 2.3.1.4 and 2.3.1.5 respectively.

2.3.2 CALL SET-UP, PROTECTION REQUIRED BY THE ORIGINATING PBX

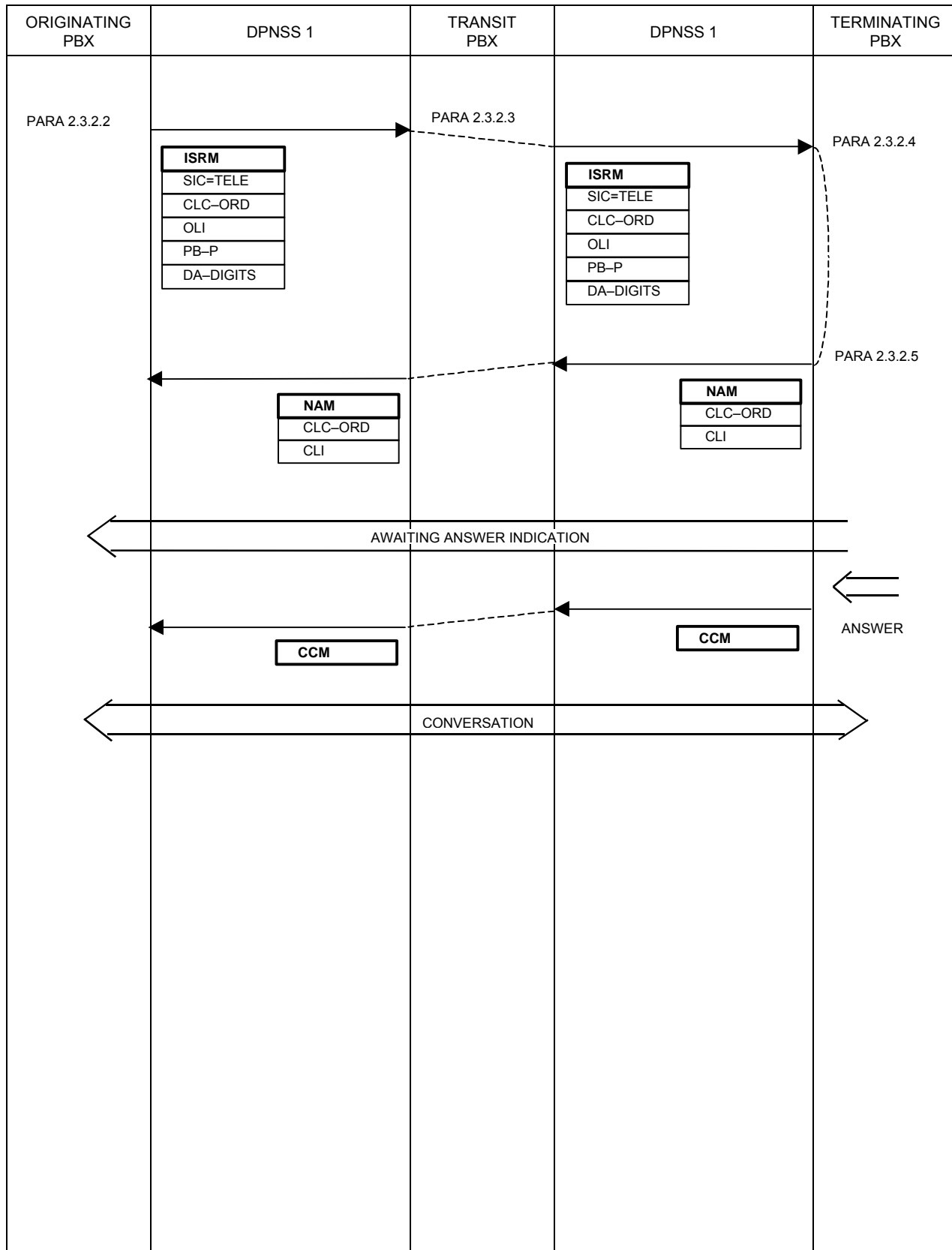

2.3.2.1 An extension at the Originating PBX calls an extension at the Terminating PBX. The Originating PBX shall determine and store the BPL and the SFI requirement for this call.

2.3.2.2 If the required BPL is greater than 0, the ISRM shall contain String PB-P with Parameter BPL and optionally, String SFI.

2.3.2.3 A Transit PBX, on receipt of the ISRM, shall store the BPL (and SFI, if requested) before repeating the ISRM towards the Terminating PBX.

As String PB-B is optional, any PBX not recognising it will allow the call to continue but will return a NIM containing String IG-SNU to indicate such. This may be used by the Originating PBX to indicate that protection was not applied.

2.3.2.4 On receipt of the ISRM the Terminating PBX shall store the BPL (and SFI, if requested). This information may be indicated to the called party. The call shall proceed as for a Simple Call.

2.3.2.5 If the called extension requires a protection level higher than that received in string PB-P, the procedures of paragraphs 2.3.1.3, 2.3.1.4 and 2.3.1.5 shall apply.

2.3.2.6 If, after answer, the Terminating PBX needs to change the BPL, the procedures of paragraph 2.3.1.6 shall apply. However, the BPL shall not be changed to a value lower than that received in the ISRM.

2.3.2.7 If, after answer, the Originating PBX needs to change the BPL (eg on request from the calling user), it shall send an LLM containing String PB-P. The BPL shall not be changed to a value lower than any received from the Terminating PBX. Transit PBXs shall store the new BPL and pass the LLM on to the next PBX. The Terminating PBX shall store the new BPL.

2.3.3 BREAKDOWN AT A BUSY EXTENSION

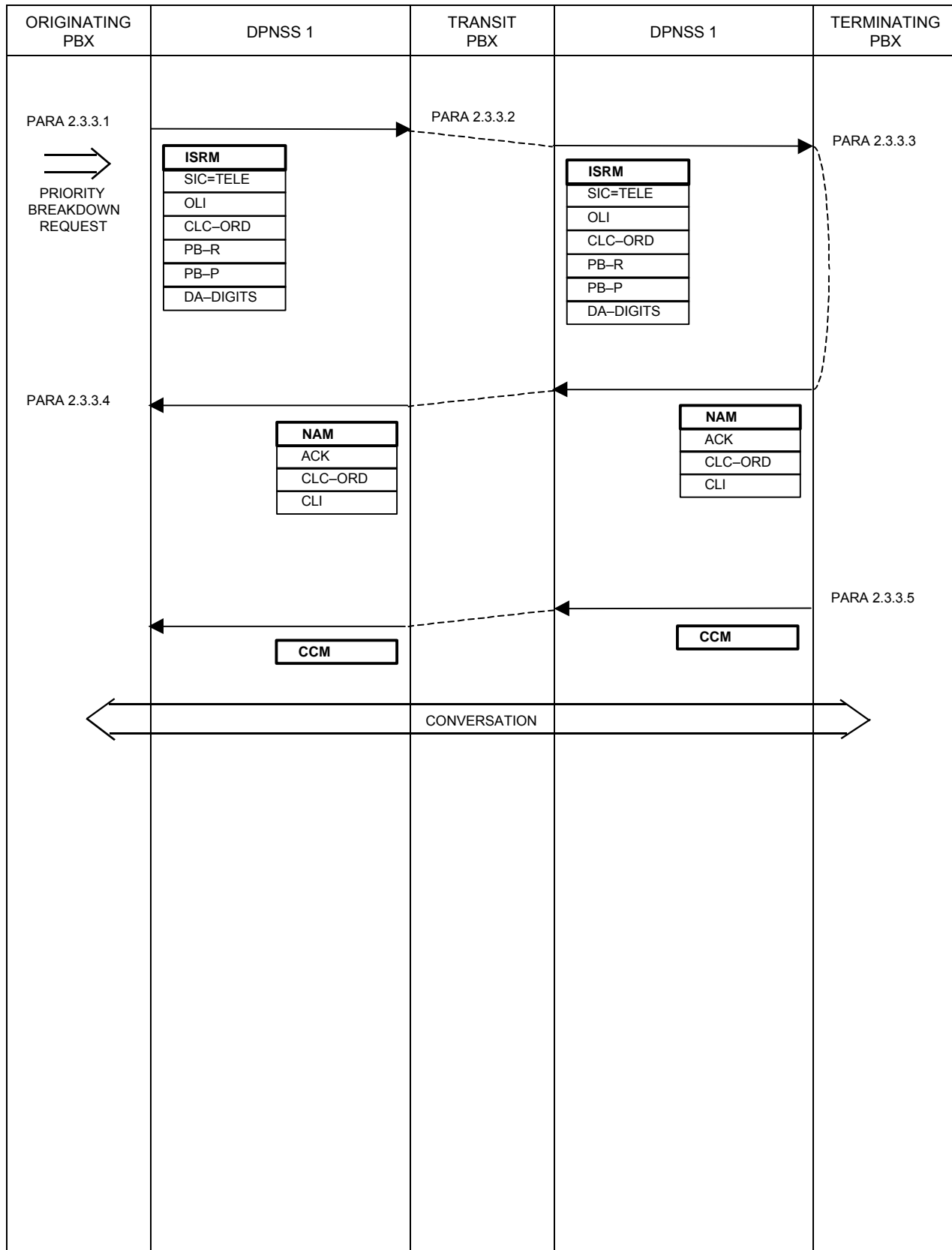

2.3.3.1 A caller may request Priority Breakdown, either in anticipation of encountering congestion or called extension busy, or following a previous call attempt which has encountered congestion or called extension busy.

The Originating PBX shall determine the extension's Breakdown Capability Level (BCL) and Breakdown Protection Level (BPL). If the BCL is zero the call shall be rejected; otherwise it shall be allowed to proceed. If a DPNSS 1 channel is selected, strings PB-R (containing the BCL as a Parameter) and PB-P (containing the BPL as a Parameter) shall be included in the ISRM.

2.3.3.2 Transit PBXs shall handle the call normally but shall store the BPL.

2.3.3.3 In this example the call reaches the Terminating PBX and the called extension is found to be busy. The BCL of the new call shall be compared with the BPL of the existing call and, if greater, the existing call shall be cleared. If the existing call is via DPNSS 1, Clearing Cause: Priority Forced Release (PFR) shall be used. The new call's BPL shall be stored. A NAM containing ACK, in addition to the called extension's CLC and CLI, shall be returned towards the new call's Originating PBX.

If the new call's BCL is not sufficiently high the call shall be rejected by sending a CRM containing Clearing Cause: BY towards the new call's Originating PBX.

If the called extension is free when the call arrives, the new call's BPL shall be stored and the call shall proceed as for paragraph 2.3.2.4.

2.3.3.4 The presence of ACK in the NAM indicates to the Originating PBX that breakdown is taking place at the called extension.

2.3.3.5 The new call shall be connected to the called extension, perhaps after a short delay while an indication is given to the extension. An in-band breakdown indication may optionally be sent to the calling party during this period. When connection is complete a CCM shall be sent and the call shall proceed as for a Simple Call.

If the called extension clears before connection is complete it shall be called again. Awaiting Answer indication shall be sent to the caller in the traffic channel and an EEM containing SOD-F sent in the signalling channel. A CCM shall be sent on answer.

Some PBXs may choose to prevent the connection of the new call until the called party has cleared.

2.3.4 BREAKDOWN AFTER CONGESTION IS ENCOUNTERED

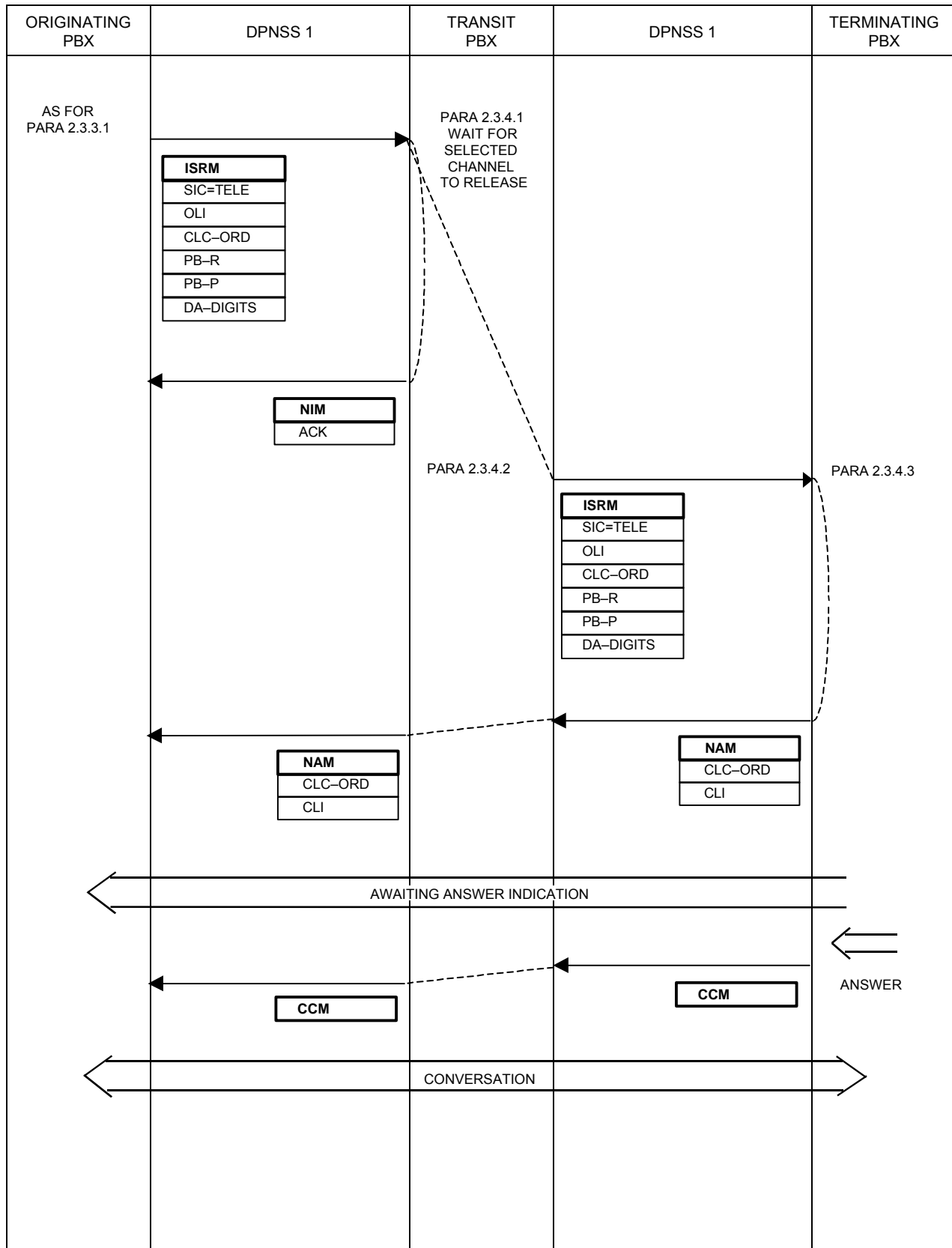

2.3.4.1 In this example a Transit PBX is unable to find a free channel on the outgoing DPNSS 1 route. Because the received ISRM contains string PB-R, the Transit PBX shall examine the BPLs of all existing calls on the required route and select the call with the lowest BPL. If that BPL is lower than the BCL of the new call, the selected call shall be released with Clearing Cause: Priority Forced Release (PFR). The new call cannot proceed until a CIM has been received. The BPL of the new call shall be stored and a NIM containing ACK sent towards the new call's Originating PBX to indicate that breakdown is taking place at a Transit PBX.

If a channel with a sufficiently low BPL is not found the new call shall be rejected by sending a CRM containing Clearing Cause: CON towards the Originating PBX.

2.3.4.2 On receipt of a CIM from the selected channel, or if any other suitable channel becomes free in the meantime, the new call may proceed by passing on the ISRM.

If call collision occurs, and if no alternative channel has become free, an attempt shall be made to break-down another channel.

If, after sending a CRM on the selected DPNSS 1 channel, a CIM is not received within 10 ± 1 s, and if no alternative channel has become free, an attempt shall be made to break-down another channel. Repeat attempts should be made to release the original channel, according to the rules of SECTION 5, Paragraph 3.2.

A PBX should limit the number of unsuccessful attempts to break-down calls on channels. If this limit is reached the PBX should reject the new call by sending a CRM with Clearing Cause: CON towards the Originating PBX.

2.3.4.3 If the called extension is free the Terminating PBX shall store the BPL and treat the call as a Simple Call. If the called extension is busy, the procedures detailed in Paragraph 2.3.3.3 onwards shall apply.

3 COMPLIANCE

The Priority Breakdown Supplementary Service is an optional part of DPNSS 1 and its provision on a PBX is a matter for negotiation between a customer and his supplier (see FOREWORD in SECTION 0 of this specification). This Subsection may be used as an aid to those negotiations.

NOTE: Whilst the provision of this Supplementary Service is optional, if it is provided, compliance with certain features of the service becomes mandatory.

Compliance with the service is considered in terms of the function(s) to be performed by the PBX ie Transit, End or Branching and the extent to which extensions or operators on the PBX can request the service.

The options available are given in TABLE 1. This table should be completed by a manufacturer to indicate PBX capability and by a purchaser to indicate PBX requirements.

TABLES 2 to 5 indicate the features that are required/provided at each PBX. The pre-printed "YES" indicates that the feature is a mandatory part of the service for that PBX function.

TABLE 1

PBX FUNCTION	APPLICABLE TABLES
PBX with operators or extensions, some of which can request Priority Breakdown	TABLES 2, 3 & 4
PBX with operators or extensions, some of which can request Breakdown Protection	TABLES 2 & 3
PBX with operators or extensions, none of which can request the service	TABLE 2
Transit PBX	TABLE 5

TABLE 2

COMPLIANCE TABLE FOR A PBX WITH OPERATORS OR EXTENSIONS IN A NETWORK THAT SUPPORTS PRIORITY BREAKDOWN		
SERVICE VARIANT		COMMENT
Able to respond correctly to a request to store the received Protection Level?	YES	
Able to respond correctly to a request to break-down a call?	YES	

TABLE 3

ADDITIONAL COMPLIANCE TABLE FOR A PBX WITH OPERATORS OR EXTENSIONS, SOME OF WHICH CAN REQUEST BREAKDOWN PROTECTION		
SERVICE VARIANT		COMMENT
Able, as an Originating PBX, to request protection at call set up?	YES	
Able, as a Terminating PBX, to request protection at call set up?		
Able to request protection during a call?		
Able to request Supplementary Facilities Inhibited (SFI) when requesting protection?		

TABLE 4

ADDITIONAL COMPLIANCE TABLE FOR A PBX WITH OPERATORS OR EXTENSIONS SOME OF WHICH CAN REQUEST BREAKDOWN		
SERVICE VARIANT		COMMENT
Able to signal a request to break-down a call?	YES	
Able to update protection of a call when signalling a Priority Breakdown-Request?		

TABLE 5

COMPLIANCE TABLE FOR A TRANSIT PBX IN A NETWORK THAT SUPPORTS PRIORITY BREAKDOWN		
SERVICE VARIANT		COMMENT
Able to store the Protection Level received in an ISRM and a LLM?	YES	
Able to respond correctly to a request to break-down a call?	YES	

DIGITAL PRIVATE NETWORK SIGNALLING SYSTEM NO 1 (DPNSS 1)

SECTION 36 - SUPPLEMENTARY SERVICE: CALL BACK MESSAGING

CONTENTS

1	GENERAL	Page 2
2	CALL BACK MESSAGING WITHIN DPNSS 1	Page 3
	2.1 DEFINITION.....	Page 3
	2.2 DESCRIPTION.....	Page 3
	2.3 OUTLINE OF OPERATION.....	Page 3
	2.3.1 Delivery of a Message.....	Page 4
	2.3.2 Cancellation of a Message.....	Page 6
	2.3.3 Call Set Up.....	Page 8
3	COMPLIANCE	Page 9

HISTORY

Issue 1 - March 1986

Issue 2 - December 1989

Issue 3 - March 2001 - Specification renamed as DPNSS[188]
 - Call Set Up String added

1 GENERAL

- 1.1** This Section details the signalling requirements of DPNSS 1 for the Call Back Messaging Supplementary Service.
- 1.2** Subsection 2 details the service within DPNSS 1.
- 1.3** Subsection 3 shows the Compliance.
- 1.4** The description is given in the form of Message Sequence Diagrams (MSDs) followed by explanatory text.
- 1.5** The text is referenced from MSDs at appropriate points in the sequence.
- 1.6** Message contents for successful calls are shown in MSDs. Messages and their contents for alternative sequences (eg unsuccessful calls) are detailed in the text.
- 1.7** Coding of the contents of messages is given in SECTION 4.

2 CALL BACK MESSAGING WITHIN DPNSS 1

2.1 DEFINITION

The Call Back Messaging Supplementary Service allows a caller to indicate to the called party that the calling party wishes to be called back.

2.2 DESCRIPTION

When the Call Back Messaging Supplementary Service is invoked the originator of a call sends a message to the called party, indicating the identity of the caller. This may be used for example:

- after encountering a busy extension
- after no reply
- or
- by a message centre wishing to contact the called party

The recipient of the Call Back Indication (Message) may then initiate a call without the need to enter the required Destination Address.

2.3 OUTLINE OF OPERATION

The service is implemented across a DPNSS network by means of the following signalling sequences:

- 2.3.1 Delivery of a Message
- 2.3.2 Cancellation of a Message
- 2.3.3 Call Set Up

2.3.1 DELIVERY OF A MESSAGE

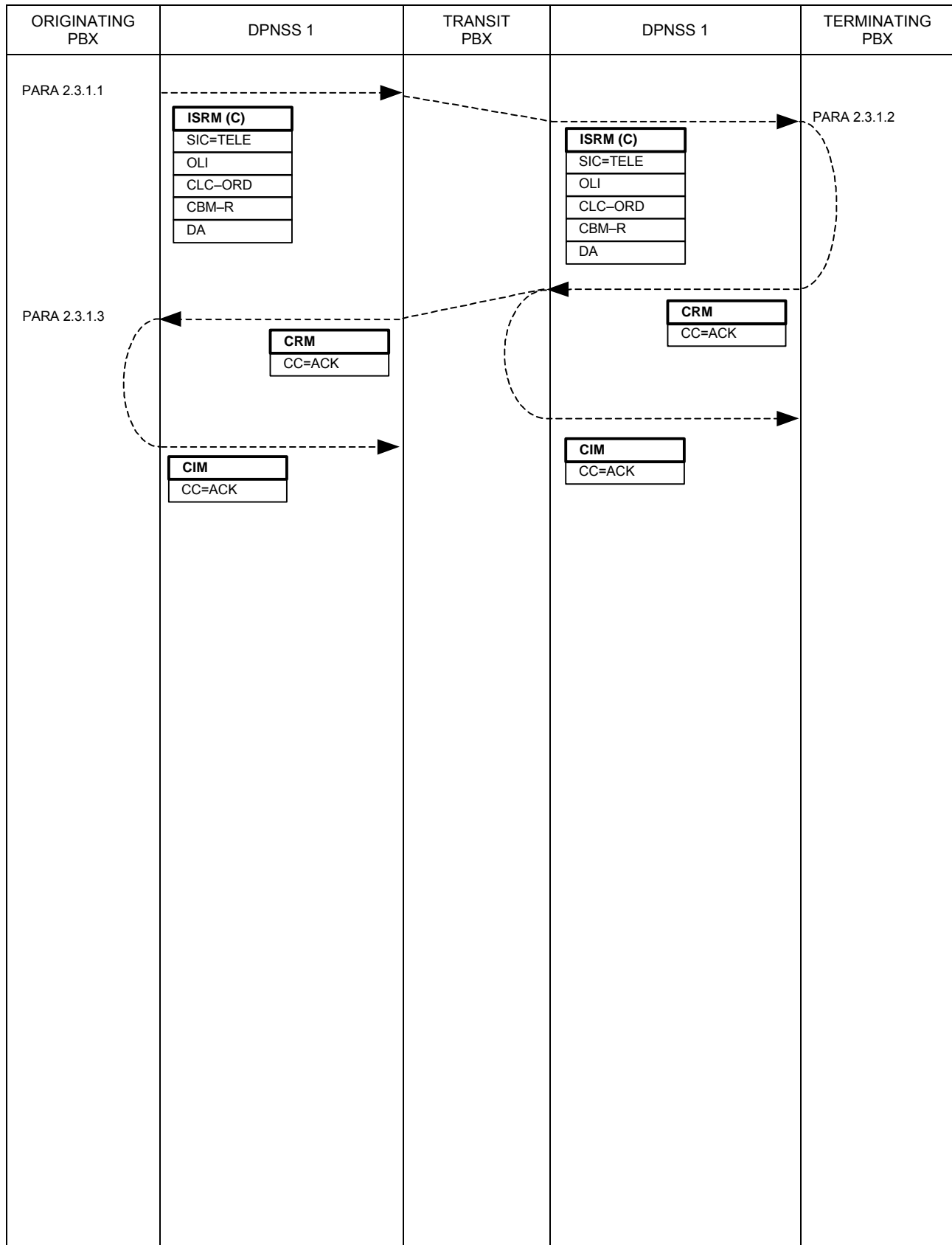

2.3.1.1 The Call Back Messaging Request shall be validated by the Originating PBX, and a Virtual Call established by sending an ISRM containing the String "Call Back Messaging-Request" (CBM-R) and optionally the string "TEXT".

2.3.1.2 The Call Back Messaging Request shall be validated by the Terminating PBX.

If the request is accepted, the Originating Line Identity (OLI) and any associated TEXT shall be stored against the called extension. The way in which the user is informed and the subsequent handling of the request are PBX dependent. A CRM containing Clearing Cause: Acknowledge (ACK) shall be returned.

If the request is unacceptable a CRM, containing Clearing Cause: Service Unavailable, Service Temporarily Unavailable or Subscriber Out of Service, shall be sent to the Originating PBX.

Service Unavailable shall be used when the called extension is barred CBM - Requests. Service Temporarily Unavailable shall be used when the Terminating PBX is temporarily unable to accept further requests, eg queue full.

2.3.1.3 On receipt of a CRM containing Clearing Cause: Acknowledge (ACK), the Originating PBX may give an appropriate confirmation indication to the requesting party. No record of the service shall be retained at the Originating PBX.

Receipt of a CRM containing a Clearing Cause other than ACK, indicates that the request has been unsuccessful. An appropriate indication may be given to the requesting party.

2.3.2 CANCELLATION OF A MESSAGE

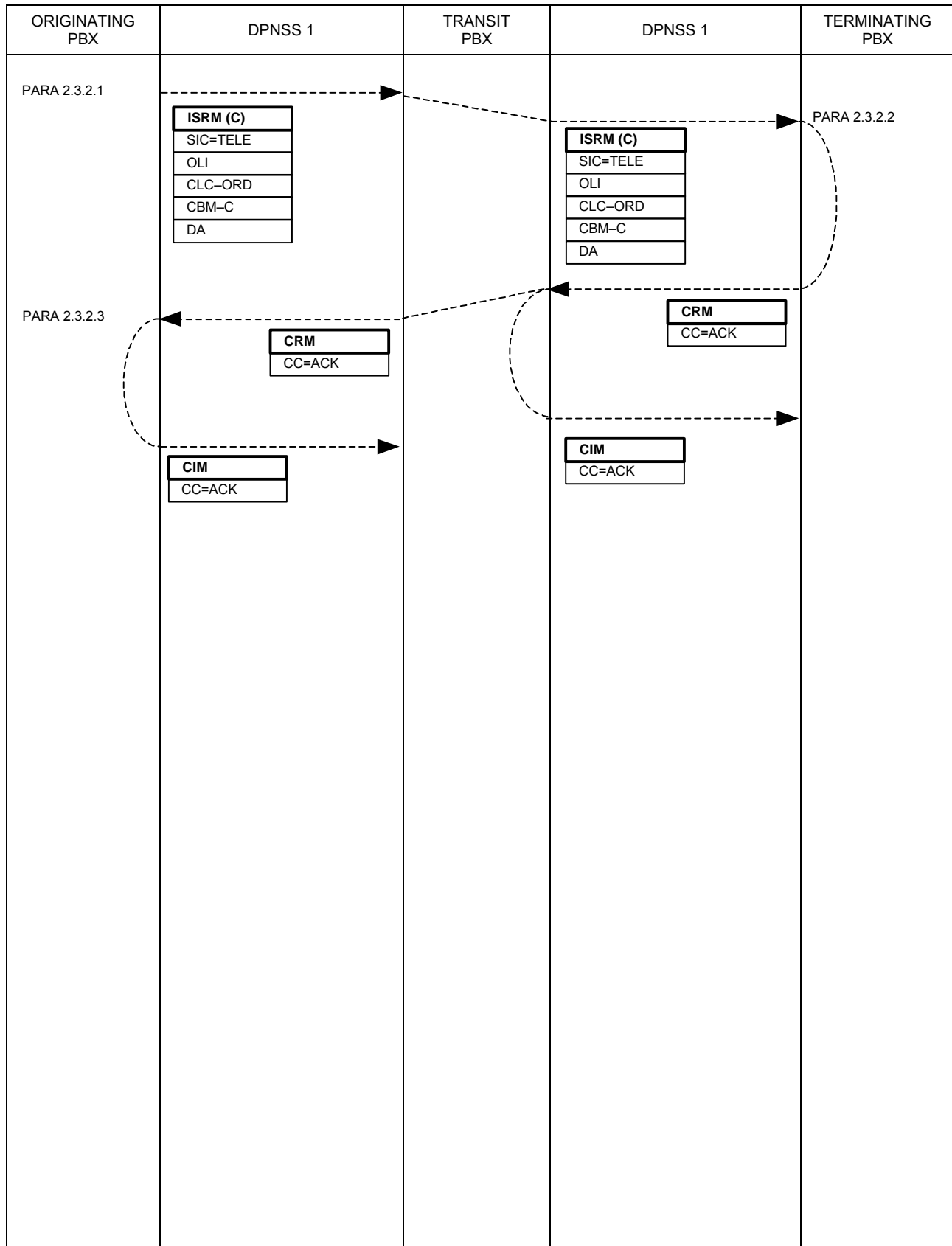

2.3.2.1 The Call Back Messaging Cancellation shall be validated by the Originating PBX, and a Virtual Call established by sending an ISRM containing the String "Call Back Messaging - Cancel" (CBM-C).

2.3.2.2 The Call Back Messaging Cancellation shall be validated by the Terminating PBX.

If a request from the originator (as indicated by the OLI) exists for the required destination, it shall be cancelled and a CRM containing Clearing Cause: Acknowledge (ACK) returned.

If no request is held, a CRM containing Clearing Cause: Facility Not Registered (FNR) shall be returned.

2.3.2.3 On receipt of a CRM containing Clearing Cause: ACK, the Originating PBX may give an appropriate confirmation indication to the requesting party.

Receipt of a CRM containing a Clearing Cause other than ACK indicates that the request has been unsuccessful. An appropriate indication may be given to the requesting party.

2.3.3 CALL SET UP

2.3.3.1 When the recipient of a Call Back Indication (Message) initiates a call due to the Call Back Messaging - Request this may be indicated by including the String "Call Back Messaging - Call Set Up" (CBM-CSU) in the ISRM.

2.3.3.2 On receipt of an ISRM containing a CBM-CSU String the action taken at the Terminating PBX is PBX dependent.

3 COMPLIANCE

The Call Back Messaging Supplementary Service is an optional part of DPNSS 1 and its provision on a PBX is a matter for negotiation between a customer and his supplier (see FOREWORD in SECTION 0 of this specification). This subsection may be used as an aid to those negotiations.

NOTE: Whilst the provision of this Supplementary Service is optional, if it is provided, compliance with certain features of the service becomes mandatory.

Compliance with the service is considered in terms of the function(s) to be performed by the PBX ie Transit, End, or Branching and the extent to which extensions or operators on the PBX can request the service.

The options available are given in TABLE 1. This table should be completed by a manufacturer to indicate PBX capability and by a purchaser to indicate PBX requirements.

TABLES 2 to 4 indicate the features that are required/provided at each PBX. The pre-printed "YES" indicates that the feature is a mandatory part of the service for that PBX function.

TABLE 1

PBX FUNCTION		APPLICABLE TABLE
PBX with operators or extensions, some of which can request the service.		TABLE 3
PBX with operators or extensions, some of which can accept Call Back Messages.		TABLE 2
Transit PBX		TABLE 4

TABLE 2

COMPLIANCE TABLE FOR A PBX WITH EXTENSIONS THAT CAN ACCEPT CALL BACK MESSAGES		
SERVICE VARIANT		COMMENT
Able to accept a Call Back Messaging - Request?	YES	
Able to accept a Call Back Messaging - Cancellation?	YES	
Able to send a Call Back Messaging - Call Set Up?		

TABLE 3

COMPLIANCE TABLE FOR PBXS WITH EXTENSIONS THAT ARE ABLE TO REQUEST CALL BACK MESSAGING		
SERVICE VARIANT		COMMENT
Able to send a Call Back Messaging - Request?	YES	
Able to send a Call Back Messaging - Cancellation?		
Able to act upon receipt of a Call Back Messaging - Call Set Up?		Specify action taken

TABLE 4

COMPLIANCE TABLE FOR A TRANSIT PBX IN A NETWORK THAT SUPPORTS CALL BACK MESSAGING		
SERVICE VARIANT		COMMENT
Able to act as a Transit for: - a Call Back Messaging - Request? - a Call Back Messaging - Cancellation? - a Call Back Messaging - Call Set Up?	YES	Inherent DPNSS 1 capability

DIGITAL PRIVATE NETWORK SIGNALLING SYSTEM NO 1 (DPNSS 1)

SECTION 37 - SUPPLEMENTARY SERVICE: LOOP AVOIDANCE

CONTENTS

1	GENERAL	Page 2
2	LOOP AVOIDANCE WITHIN DPNSS 1	Page 3
	2.1 DEFINITION.....	Page 3
	2.2 DESCRIPTION.....	Page 3
	2.3 OUTLINE OF OPERATION.....	Page 3
3	COMPLIANCE	Page 5

HISTORY

Issue 1 - March 1986

Issue 2 - December 1989

Issue 3 - March 2001 - Specification renamed as DPNSS[188]

1 GENERAL

- 1.1** This Section details the signalling requirements of DPNSS 1 for the Loop Avoidance Supplementary Service.
- 1.2** Subsection 2 details the service within DPNSS 1.
- 1.3** Subsection 3 shows the Compliance.
- 1.4** The description is given in the form of explanatory text only.
- 1.5** Coding of the contents of messages is given in SECTION 4.

2 LOOP AVOIDANCE WITHIN DPNSS 1

2.1 DEFINITION

The Loop Avoidance Supplementary Service allows a limit to be placed on the number of PBXs through which a call may pass.

As an option, it allows a limit to be placed on the number of alternative routes that a call path may include.

2.2 DESCRIPTION

Errors in the configuration of a network may make it possible for a call to be misrouted and arrive at a PBX through which it has already passed, and thus continue round in a loop using up all available channels. Calls which undergo alternative routing at one or more of the PBXs through which they pass are particularly vulnerable, since it is difficult to test every possibility at configuration time. In some networks, it may be impossible to avoid configuring a potential loop, albeit one which can occur only under extreme conditions, in order to achieve the desired alternative routing capability under moderate congestion conditions.

If a call which enters a loop is allowed to continue, it will eventually use up all channels and will be rejected on encountering congestion. However, this may take a long time and the channels it is using will not be available for other calls. A more serious problem arises if the caller clears: the Clear Request will go forward freeing channels and making them available to the call, enabling it to continue indefinitely.

The Loop Avoidance Supplementary Service permits the counting of DPNSS 1 Transit PBXs encountered and, optionally, the counting of alternative routes taken. If either count exceeds a pre-determined limit (the limits for each count being set independently), the call is rejected.

2.3 OUTLINE OF OPERATION

This facility is implemented by including the Loop Avoidance (LA) String in the ISRM or RM. This String contains two Parameters, the second of which is optional. The first Parameter is used to count down the Transit PBXs through which the call passes. The second Parameter, if present, is used to count down the number of alternative routes which the current call path has taken.

A Transit PBX, on receipt of an ISRM or RM which does not contain String LA, shall insert the String before passing the message on to the next PBX. The Transit count shall be set to the maximum number of further Transit PBXs the call may pass through. The alternative route count, if required, shall be set to the maximum number of further alternative

routes allowed for any call path which may be taken. These counts shall be configurable, varying from network to network and, possibly, from PBX to PBX within a network. The counts may also depend on the type of call. If a Transit PBX receives LA with only the Transit count Parameter present, it may add the alternative route count Parameter to the received String.

NOTE: The insertion of String LA or the addition of a second Parameter will involve a rearrangement of the Selection Block and in some cases will necessitate the use of an additional SSRM.

An Originating PBX may optionally include String LA in an ISRM or RM; by so doing it is able to specify the count.

A Transit PBX, on receipt of an ISRM or RM containing String LA, will inspect the Transit count in the first Parameter. If the count is zero, the call shall be rejected by sending a CRM or RRM with Clearing Cause: Network Termination (NT). An LA String with a count of zero may also be included in order to indicate to the Originating PBX the reason for the call being rejected. If the count is non-zero then it shall be decremented and the new value shall be passed on as the Parameter of String LA in the ISRM or RM sent to the outgoing channel.

If a Transit PBX receives String LA and the alternative route Parameter is present, and if the outgoing route is the first-choice route or the optional alternative routing control is not supported, the Parameter shall be passed on unchanged. If the outgoing route is not the first-choice route (either because the first-choice route is busy or because a previous attempt to use it resulted in the receipt of a CRM or RRM indicating congestion), the alternative-route count shall be examined. If it is set to zero, then the outgoing route shall not be used and the incoming call shall be rejected by sending a CRM or RRM containing Clearing Cause: Congestion (CON). Otherwise, it shall be decremented and the new value shall be passed on as the second Parameter of String LA in the ISRM or RM sent to the outgoing channel. If a third (or higher) choice route is selected, the alternative-route count shall have the same value as that determined for the second-choice route, ie the received alternative-route count shall be decremented once and only once at a given PBX where alternative routing takes place.

The LA String shall be ignored by the Terminating PBX.

3 COMPLIANCE

The Loop Avoidance Supplementary Service is an optional part of DPNSS 1 and its provision on a PBX is a matter for negotiation between a customer and his supplier (see FOREWORD in SECTION 0 of this specification). This subsection may be used as an aid to those negotiations.

NOTE: Whilst the provision of this Supplementary Service is optional, if it is provided, compliance with certain features of the service becomes mandatory.

Compliance with the service is considered in terms of the function(s) to be performed by the PBX, ie Transit, End, or Branching, and the extent to which extensions or operators on the PBX can request the service.

The options available are given in TABLE 1. This table should be completed by a manufacturer to indicate PBX capability and by a purchaser to indicate PBX requirements.

TABLES 2 and 3 indicate the features that are required/provided at each PBX. The pre-printed "YES" indicates that the feature is a mandatory part of the service for that PBX function.

TABLE 1

PBX FUNCTION		APPLICABLE TABLE
Transit PBX in a network that supports Loop Avoidance		TABLE 2
Originating PBX that supports Loop Avoidance		TABLE 3
Terminating PBX in a network that supports Loop Avoidance		TABLE 4

TABLE 2

COMPLIANCE TABLE FOR A TRANSIT PBX IN A NETWORK THAT SUPPORTS LOOP AVOIDANCE		
SERVICE VARIANT		COMMENT
Able to insert a Loop Avoidance String before passing on an ISRM or RM which does not already have one?	YES	Specify how Transit count is determined
Able to add an alternative routing count to an inserted Loop Avoidance String?		Specify how count is determined
Able to add an alternative routing count to a received Loop Avoidance String which does not already have one?		Specify how count is determined
Able to decrement the Transit count in a Loop Avoidance String before passing on an ISRM or RM?	YES	
Able to decrement the alternative route count in a Loop Avoidance String before passing on an ISRM or RM?		
Able to reject a call with a Transit count of zero?	YES	
Able to reject a call requiring re-routing with an alternative route count of zero?		
Able to insert a Loop Avoidance String in a CRM when rejecting a call with Transit count of zero?		

TABLE 3

COMPLIANCE TABLE FOR AN ORIGINATING PBX IN A NETWORK THAT SUPPORTS LOOP AVOIDANCE		
SERVICE VARIANT		COMMENT
Able to insert a Loop Avoidance String in an ISRM or RM?	YES	Specify how Transit count is determined
Able to add an alternative-routing count to an inserted Loop Avoidance String?		Specify how count is determined
Able to take special action on receipt of a Loop Avoidance String in a CRM?		Specify action taken

TABLE 4

COMPLIANCE TABLE FOR A TERMINATING PBX IN A NETWORK THAT SUPPORTS LOOP AVOIDANCE		
SERVICE VARIANT		COMMENT
Able to receive DPNSS 1 calls where the ISRM contains a Loop Avoidance String?	YES	Inherent DPNSS 1 capability

DIGITAL PRIVATE NETWORK SIGNALLING SYSTEM NO 1 (DPNSS 1)

SECTION 38 - SUPPLEMENTARY SERVICE: FORCED RELEASE

CONTENTS

1	GENERAL	Page 2
2	FORCED RELEASE WITHIN DPNSS 1	Page 3
	2.1 DEFINITION.....	Page 3
	2.2 DESCRIPTION.....	Page 3
	2.3 OUTLINE OF OPERATION.....	Page 3
	2.3.1 Forced Release.....	Page 4
3	COMPLIANCE	Page 6

HISTORY

Issue 1 - March 1986

Issue 2 - December 1989

Issue 3 - March 2001 - Specification renamed as DPNSS[188]

1 GENERAL

- 1.1** This Section details the signalling requirements of DPNSS 1 for the Forced Release Supplementary Service.
- 1.2** Subsection 2 details the service within DPNSS 1.
- 1.3** Subsection 3 shows the Compliance.
- 1.4** The description is given in the form of Message Sequence Diagrams (MSD) followed by explanatory text.
- 1.5** The text is referenced from MSDs at appropriate points in the sequence.
- 1.6** Message contents for successful calls are shown in MSDs. Messages and their contents for alternative sequences (eg for unsuccessful calls) are detailed in the text.
- 1.7** Coding of the contents of messages is given in SECTION 4.

2 FORCED RELEASE WITHIN DPNSS 1

2.1 DEFINITION

The Forced Release Supplementary Service offers an intruding party the possibility of forcing the release of an unwanted party.

2.2 DESCRIPTION

The party (eg an operator) who has intruded on a call initially establishes a three party conference with them. The intruding party may then force the release of the unwanted party.

If intrusion is permitted then, normally, Forced Release should also be permitted. However, the wanted party may have the capability of rejecting Forced Release.

The intrusion capability of the intruder is assumed to have been validated earlier.

2.3 OUTLINE OF OPERATION

The facility is implemented using the following signalling sequence:

2.3.1 FORCED RELEASE

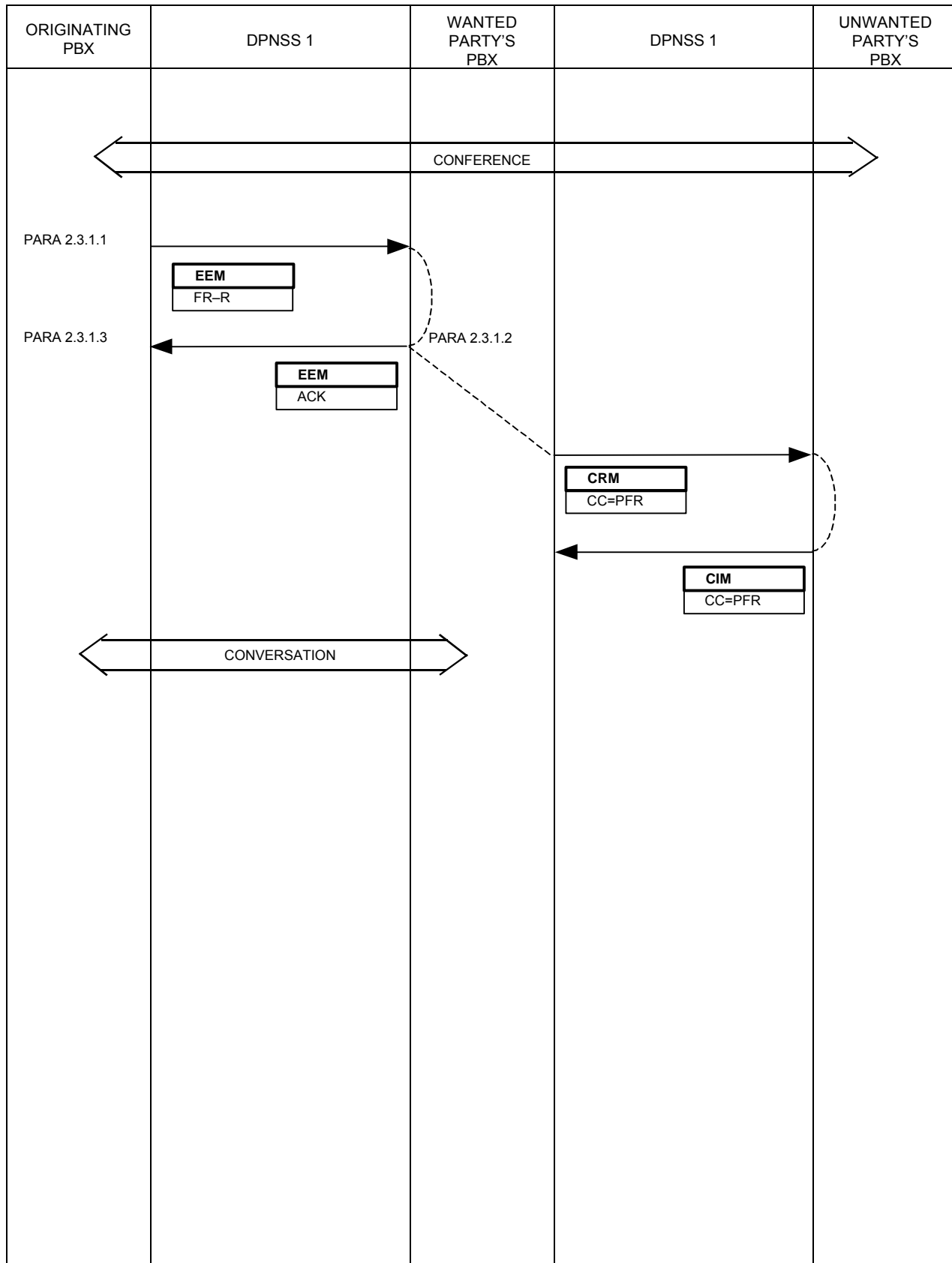

2.3.1.1 After establishing the conference the intruder enters a Forced Release Request. An EEM containing Forced Release Request (FR-R) shall be sent to the wanted party's PBX.

2.3.1.2 When the EEM containing FR-R is received, the connection to the unwanted party shall be broken and an EEM containing Acknowledge (ACK) returned to the Originating PBX. A CRM containing Clearing Cause: Priority Forced Release (PFR) shall then be sent to the unwanted party's PBX. A CIM shall be expected in response. The wanted party shall remain connected to the intruder.

If the wanted party's PBX is not able to accept the Forced Release Request, then the PBX shall return an EEM containing String Reject (REJ) and remain in the conference state.

2.3.1.3 Receipt of an EEM containing SNU or REJ indicates that the request has failed.

3 COMPLIANCE

The Forced Release Supplementary Service is an optional part of DPNSS 1 and its provision on a PBX is a matter for negotiation between the customer and his supplier (see FOREWORD in SECTION 0 of this specification). This Subsection may be used as an aid to those negotiations.

NOTE: Whilst the provision of this Supplementary Service is optional, if it is provided, compliance with certain features of the service becomes mandatory.

Compliance with the service is considered in terms of the function(s) to be performed by the PBX ie Transit, End or Branching and the extent to which extensions or operators on the PBX can request the service.

The options available are given in TABLE 1. This table should be completed by a manufacturer to indicate PBX capability and by a purchaser to indicate PBX requirements.

TABLES 2 to 4 indicate the features that are required/provided at each PBX. The pre-printed "YES" indicates that the feature is a mandatory part the service for that PBX function.

TABLE 1

PBX FUNCTION		APPLICABLE TABLE
PBX with operators or extensions some of which can request the service.		TABLE 2
PBX with extensions capable of being intruded upon and accepting forced release.		TABLE 3
Transit PBX		TABLE 4

TABLE 2

COMPLIANCE TABLE FOR A PBX WITH OPERATORS OR EXTENSIONS CAPABLE OF REQUESTING FORCED RELEASE		
SERVICE VARIANT		COMMENT
Able to send a Forced Release-Request?	YES	

TABLE 3

COMPLIANCE TABLE FOR A PBX WITH EXTENSIONS CAPABLE OF ACCEPTING FORCED RELEASE		
SERVICE VARIANT		COMMENT
Able to accept a Forced Release Request?	YES	

TABLE 4

COMPLIANCE TABLE FOR A TRANSIT PBX IN A NETWORK THAT SUPPORTS FORCED RELEASE		
SERVICE VARIANT		COMMENT
Able to transit Forced Release-Requests?	YES	Inherent DPNSS 1 capability

DIGITAL PRIVATE NETWORK SIGNALLING SYSTEM NO 1 (DPNSS 1)

SECTION 39 - SUPPLEMENTARY SERVICE: TEXT MESSAGE

CONTENTS

1	GENERAL	Page 2
2	TEXT MESSAGE WITHIN DPNSS 1	Page 3
	2.1 DEFINITION	Page 3
	2.2 DESCRIPTION	Page 3
	2.3 OUTLINE OF OPERATION	Page 3
	2.3.1 Text Message	Page 4
3	COMPLIANCE	Page 6

HISTORY

Issue 1 - March 1986

Issue 2 - December 1989

Issue 3 - March 2001 - Specification renamed as DPNSS[188]

1 GENERAL

- 1.1** This Section details the signalling requirements of DPNSS 1 for the Text Message Supplementary Service.
- 1.2** Subsection 2 details the service within DPNSS 1.
- 1.3** Subsection 3 shows the Compliance.
- 1.4** The description is given in the form of Message Sequence Diagrams (MSDs) followed by explanatory text.
- 1.5** The text is referenced from MSDs at appropriate points in the sequences.
- 1.6** Message contents for successful calls are shown in MSDs. Messages and their contents for alternative sequences (e.g., unsuccessful calls) are detailed in the text.
- 1.7** Coding of the contents of messages is given in SECTION 4.

2 TEXT MESSAGE WITHIN DPNSS 1

2.1 DEFINITION

The Text Message Service permits an extension user to send textual information to another extension user without the need to occupy a traffic channel.

2.2 DESCRIPTION

A user can request to send a short text message to another user in the DPNSS 1 network. The text is conveyed across the network by means of a Virtual Call and stored at the Terminating PBX or terminal for display to the user.

2.3 OUTLINE OF OPERATION

The facility is implemented using the following signalling sequence:

2.3.1 Text Message

2.3.1 TEXT MESSAGE

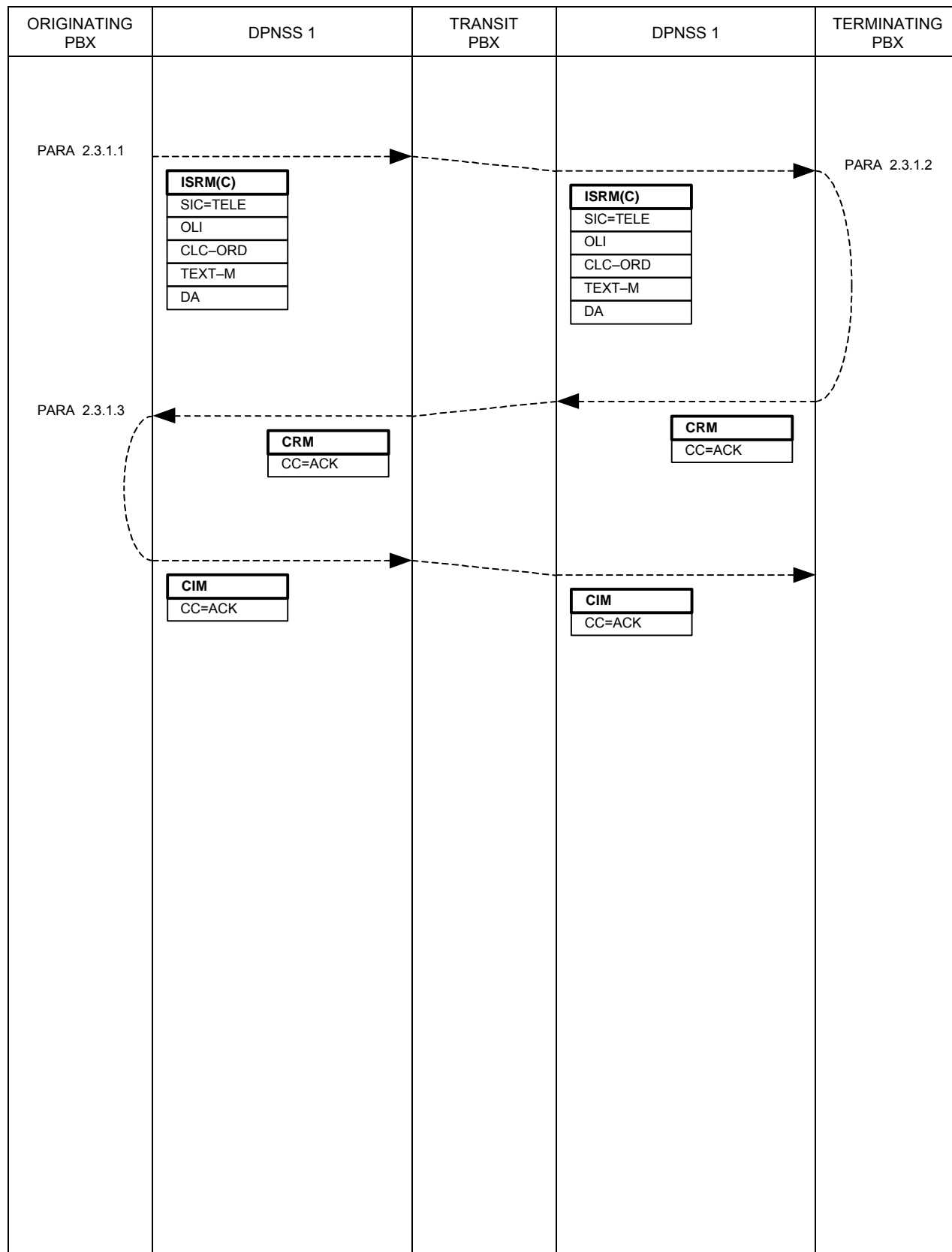

2.3.1.1 An extension user requests to send a text message to an extension on another PBX in the DPNSS 1 network. The Originating PBX shall select a free Virtual Channel and send an ISRM containing SIC=TELE, OLI, CLC, the Destination Address and TEXT-M (Text Message). The text to be displayed shall be conveyed as the Parameter to TEXT-M ("TEXT").

2.3.1.2 On receipt of an ISRM containing TEXT-M the Terminating PBX shall check that the called extension is able to receive text messages. If so, it shall store the text and clear the Virtual Call by returning a CRM containing Clearing Cause: ACK. A CIM shall be expected in response. The way in which the text is displayed to the called user is PBX dependent.

If the text cannot be accepted for display the Virtual Call shall be rejected. Clearing Cause: SU shall be used if the called extension does not have a display capability. Clearing Cause: STU shall be used if the extension is temporarily unable to accept further messages, e.g., message queue full. Clearing Cause: SOS shall be used if the called extension is out of service.

2.3.1.3 On receipt of a CRM containing Clearing Cause ACK, a confirmation indication shall be given to the requesting party.

Receipt of a CRM containing a Clearing Cause other than ACK indicates that the request has failed. An appropriate indication may be given to the requesting party.

3 COMPLIANCE

The Text Message Supplementary Service is an optional part of DPNSS 1 and its provision on a PBX is a matter for negotiation between a customer and his supplier (see FOREWORD in SECTION 0 of this specification). This Subsection may be used as an aid to those negotiations.

NOTE: Whilst the provision of this Supplementary Service is optional, if it is provided compliance with certain features of the service becomes mandatory.

Compliance with the service is considered in terms of the function(s) to be performed by the PBX, i.e. Transit, End, or Branching, and the extent to which extensions or operators on the PBX can request the service.

The options available are given in TABLE 1. This Table should be completed by a manufacturer to indicate PBX capability and by a purchaser to indicate PBX requirements.

TABLES 2 to 4 indicate the features that are required/provided at each PBX. The pre-printed "YES" indicates that the feature is a mandatory part of the service for that PBX function.

TABLE 1

PBX FUNCTION		APPLICABLE TABLE
PBX with extensions, some of which can request the sending of Text Messages		TABLE 3
PBX with extensions, some of which can accept Text Messages.		TABLE 2
Transit PBX		TABLE 4

TABLE 2

COMPLIANCE TABLE FOR A PBX WITH EXTENSIONS OR OPERATORS WHICH CAN ACCEPT TEXT MESSAGES		
SERVICE VARIANT		COMMENT
Able to accept a Text Message from another PBX?	YES	

TABLE 3

COMPLIANCE TABLE FOR A PBX WITH EXTENSIONS OR OPERATORS WHICH CAN REQUEST THE SENDING OF TEXT MESSAGES		
SERVICE VARIANT		COMMENT
Able to send a Text Message to another PBX?	YES	

TABLE 4

COMPLIANCE TABLE FOR A TRANSIT PBX IN A NETWORK THAT SUPPORTS TEXT MESSAGE		
SERVICE VARIANT		COMMENT
Able to act as a Transit for Text Messages?	YES	Inherent DPNSS 1 Capability

DIGITAL PRIVATE NETWORK SIGNALLING SYSTEM NO 1 (DPNSS 1)

SECTION 40 - SUPPLEMENTARY SERVICE: CHARGE REPORTING

CONTENTS

1	GENERAL	Page 2
2	CHARGE REPORTING FOR A DPNSS 1 CALL	Page 3
2.1	DEFINITION.....	Page 3
2.2	DESCRIPTION.....	Page 3
2.3	OUTLINE OF OPERATION.....	Page 3
2.3.1	Charging Indication.....	Page 4
2.3.2	Account Code Indication.....	Page 6
2.3.3	Rate Indication (Time Basis).....	Page 8
	Rate Indication (Unit Basis).....	Page 9
2.3.4	Call Cost During an Established Call (Information).....	Page 11
	Call Cost During an Established Call (Request).....	Page 12
2.3.5	Call Cost on Call Termination: Terminating Party Clears First.....	Page 14
	Call Cost on Call Termination: Originating Party Clears First.....	Page 15
3	COMPLIANCE	Page 17

HISTORY

Issue 1 - December 1989

Issue 2 - March 2001 - Specification renamed as DPNSS[188]

1 GENERAL

- 1.1** This Section details the signalling requirements of DPNSS 1 for the Charge Reporting Supplementary Service.
- 1.2** Subsection 2 details the service within DPNSS 1.
- 1.3** Subsection 3 shows the Compliance.
- 1.4** The description is given in the form of Message Sequence Diagrams (MSDs) followed by explanatory text.
- 1.5** The text is referenced from MSDs at appropriate points in the sequences.
- 1.6** Message contents for successful calls are shown in MSDs. Messages and their contents for alternative sequences are detailed in the text.
- 1.7** Coding of the contents of messages is given in SECTION 4.

2 CHARGE REPORTING FOR A DPNSS 1 CALL

2.1 DEFINITION

The Charge Reporting Service allows details of call cost and associated information to be passed between the parties involved in a DPNSS 1 call, where the call has been made from a DPNSS 1 extension to a destination which causes the Terminating PBX to be charged for the call, on or after answer.

2.2 DESCRIPTION

The Charge Reporting Service gives a Terminating PBX which is being charged for an answered call the ability to indicate the cost of that call to the Originating PBX in one or a combination of three forms:

- As the number of charge units used and the cost of each unit,
- As the cost of the call in monetary units;
- As the charge rate in monetary units per time unit applicable at any time.

In addition to details of cost, the service permits the Terminating PBX to indicate to the Originating PBX that the call is liable to charging and to obtain an Account Code from the Originating PBX on a charged call.

2.3 OUTLINE OF OPERATION

The signalling exchanges for each of these facilities are largely independent of one another, and for the purposes of clarity are described separately. It should be noted, however, that certain signalling sequences may occur simultaneously in that any valid combination of Strings may be sent in the same message or message sequence (eg CH-ACT and CH-ACR as described below may be received in the same message).

2.3.1 CHARGING INDICATION

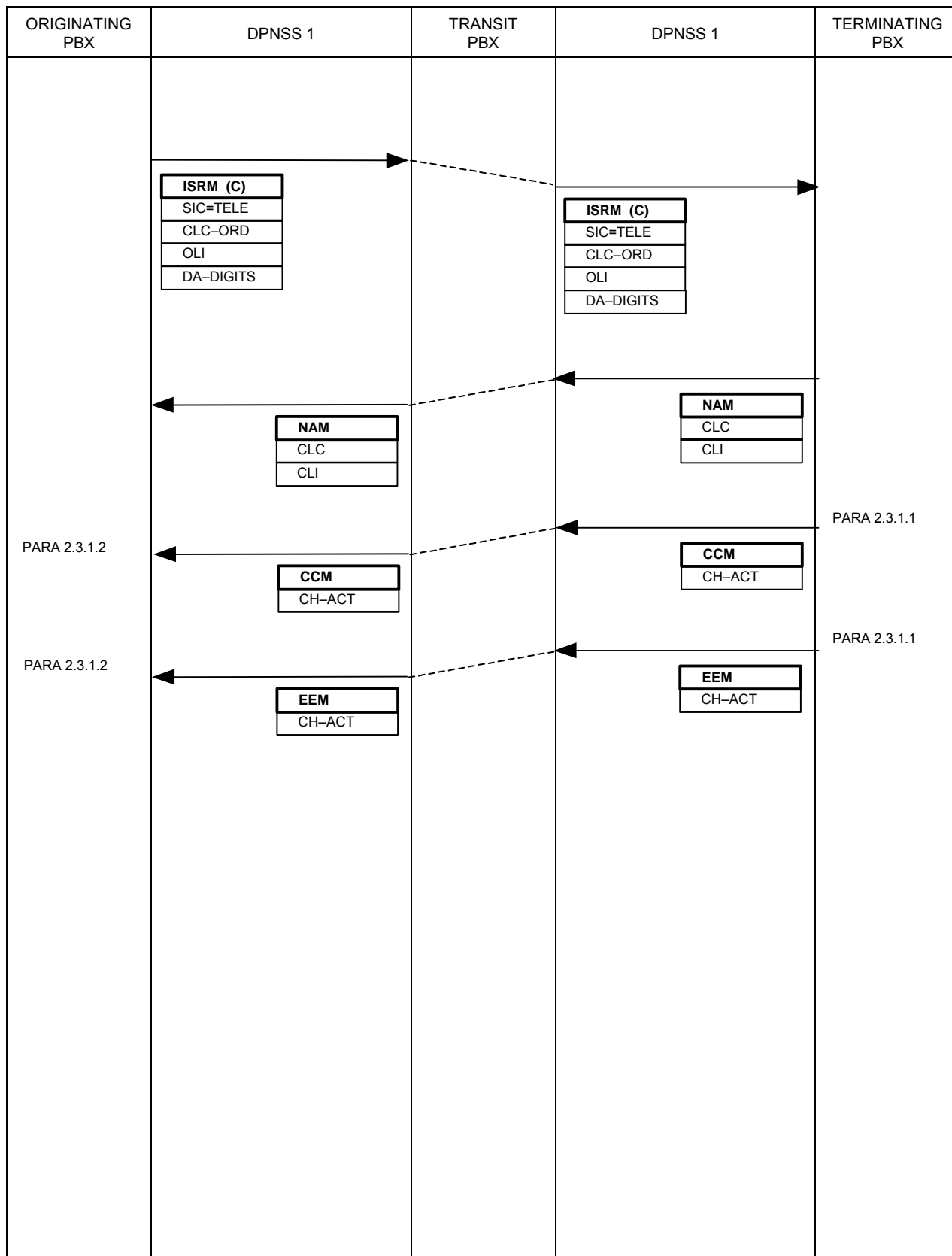

2.3.1.1 The String CH-ACT (Charging - Active) is returned by the Terminating PBX on or after answer whenever it determines that charging on a call will or may be incurred. As such, the String may be sent in a CCM or EEM, as appropriate.

2.3.1.2 The Originating PBX may use this indication for any appropriate purpose. For example, it may display a message to the originating user or prompt the user for an Account Code. It may be used by the Originating PBX to determine whether or not it is worth requesting cost data during or on termination of the call.

2.3.2 ACCOUNT CODE INDICATION

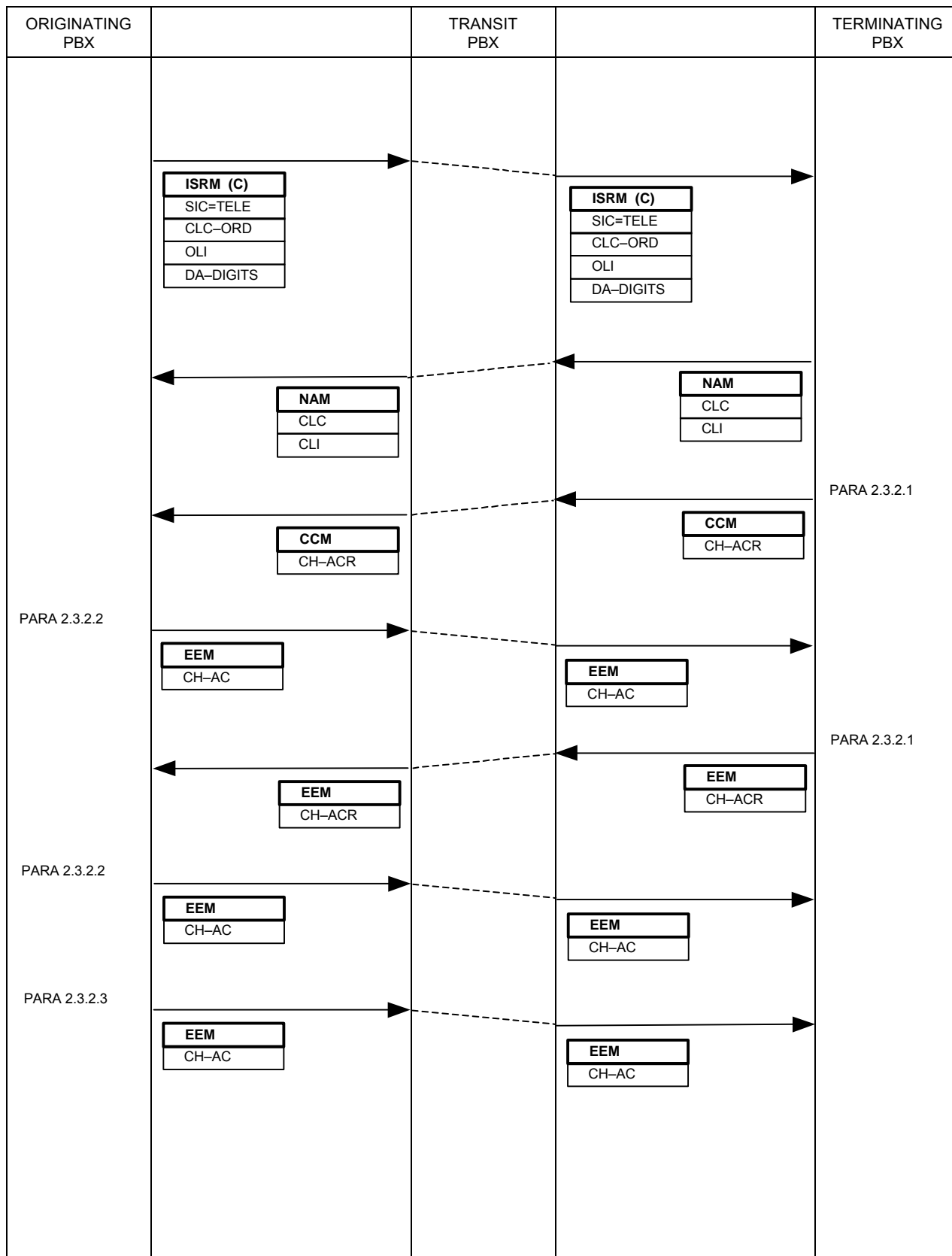

2.3.2.1 Whenever the Terminating PBX wishes to associate cost data with an Account Code attributable to the calling party, it may request an Account Code on or after answer from the Originating PBX by including the String CH-ACR (Charging - Account Code Request) in a CCM or EEM, as appropriate.

2.3.2.2 On receipt of the String CH-ACR, the Originating PBX shall return the String CH-AC (Call Charge - Account Code) in an EEM. CH-AC has, as its Parameter, a string of digits representing the Account Code of the originating party. The actual significance of these digits is PBX dependent.

If, on receipt of CH-ACR, account coding does not apply to the calling party, an EEM with SU and Parameter CH-ACR shall be returned. If account coding does apply to the calling party but is not currently available (eg the user has to be prompted for it), CH-AC shall be returned in an EEM with no Parameter to indicate that the information may become available later in the call.

2.3.2.3 If, after returning CH-AC with no Parameter, an Account Code subsequently becomes defined, or after returning one Account Code another becomes applicable, CH-AC shall be sent in an EEM detailing the new Account Code. It shall not be necessary to wait for a further request from the Terminating PBX to send this information.

2.3.3 RATE INDICATION (TIME BASIS)

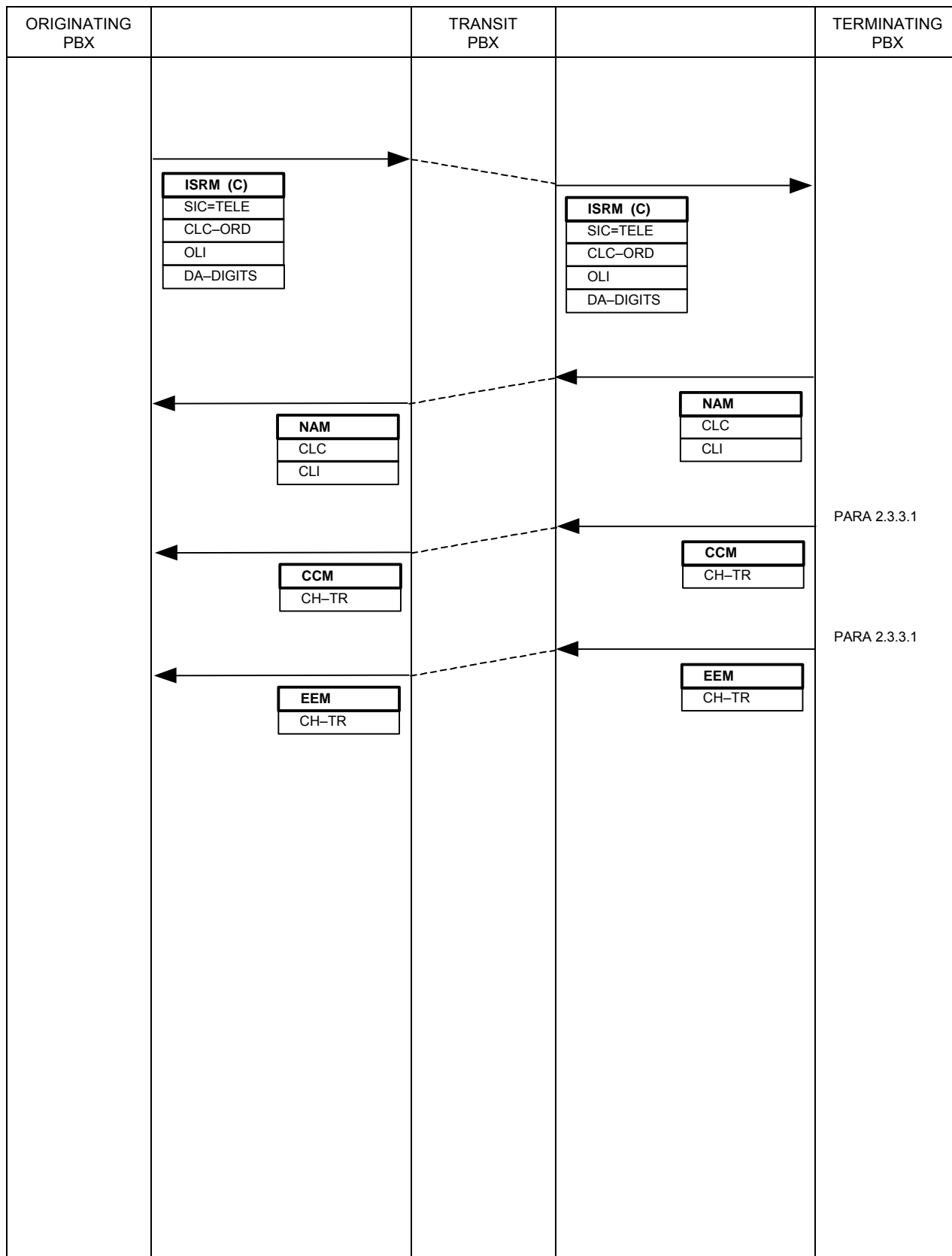

2.3.3 RATE INDICATION (UNIT BASIS)

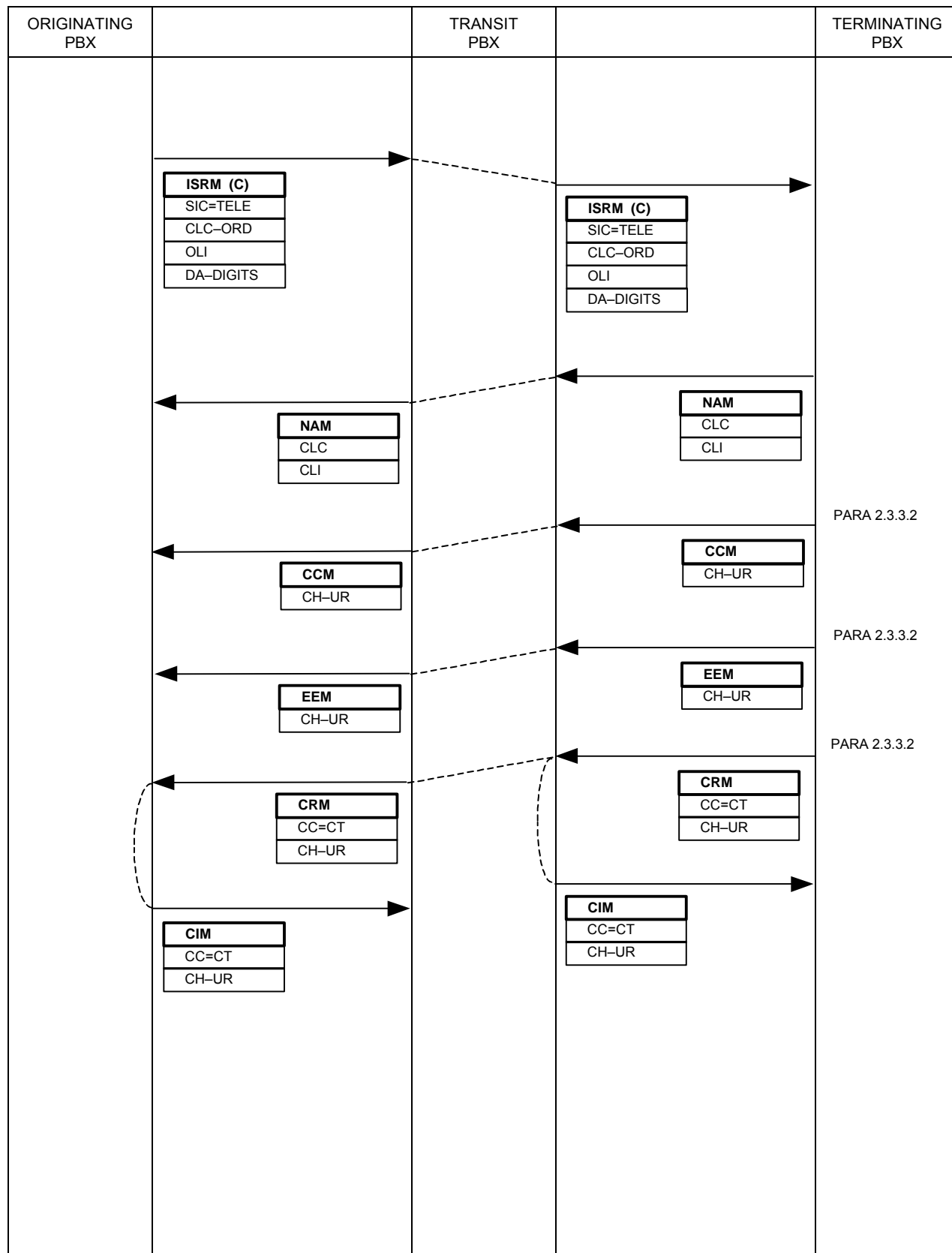

2.3.3.1 If the Terminating PBX is able to determine the timed charge rate for a call, it shall indicate this to the Originating PBX by sending the String CH-TR (Charging - Time Rate) in the CCM. CH-TR shall also be sent in an EEM whenever the Terminating PBX determines that the timed rate has changed. Thus, when supplied, the time rate refers to the rate applicable from that point until call termination or further rate notification. It is not possible to indicate time rate retrospectively.

2.3.3.2 If the Terminating PBX is able to determine the unit rate for a call, it shall indicate this to the Originating PBX by sending the String CH-UR (Charging - Unit Rate). CH-UR may be included in an EEM, CCM or CRM whenever the unit rate becomes known. Since on a call-by-call basis the unit rate should not change, CH-UR need not be sent more than once, although a PBX is free to do so as long as the Parameter is not changed. For example, it may always accompany details of units used (see 2.3.4) with CC-UR. Thus, where the Originating PBX receives CH-UR more than once, it may discard previous indications of unit rate.

2.3.4 CALL COST DURING AN ESTABLISHED CALL (INFORMATION)

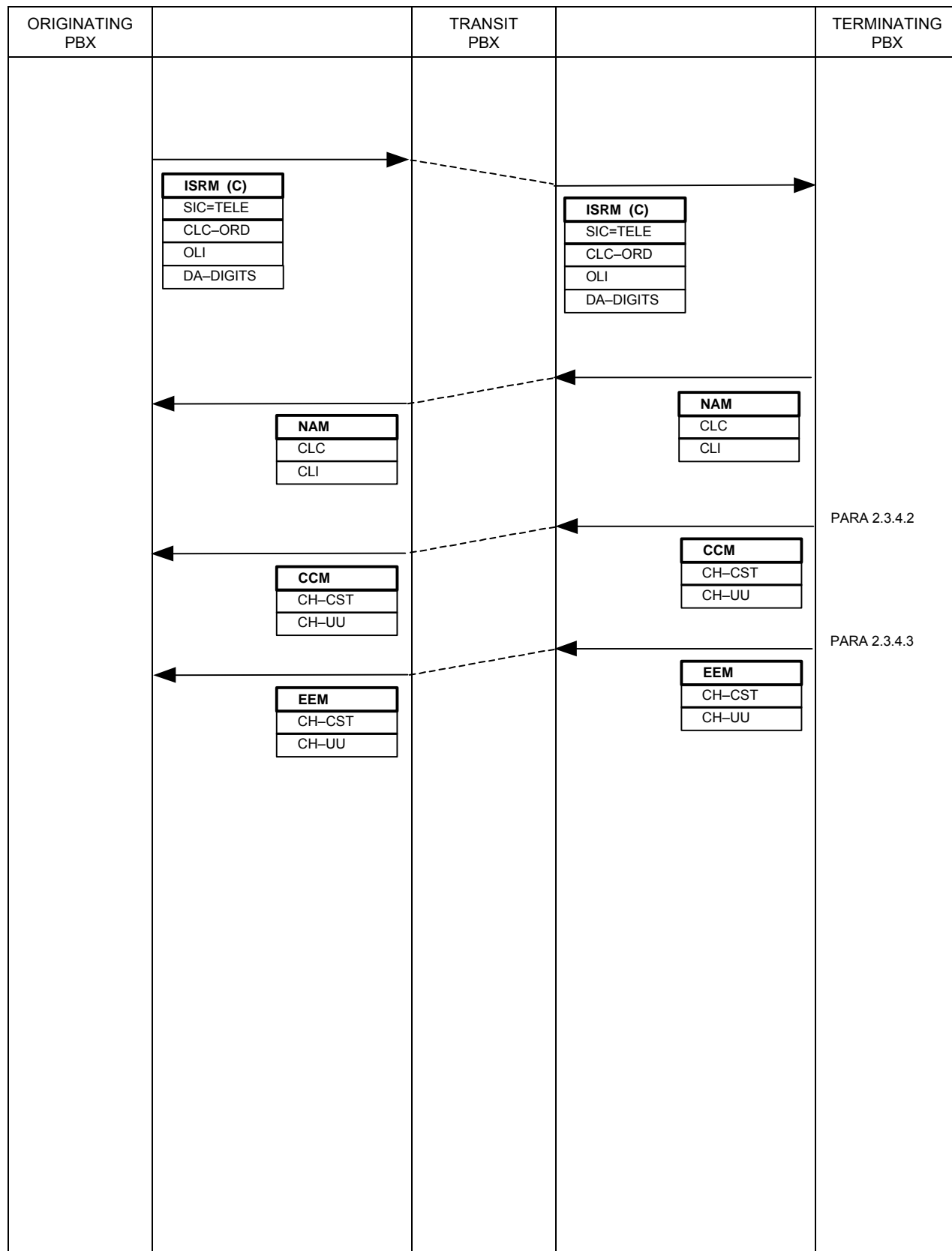

2.3.4 CALL COST DURING AN ESTABLISHED CALL (REQUEST)

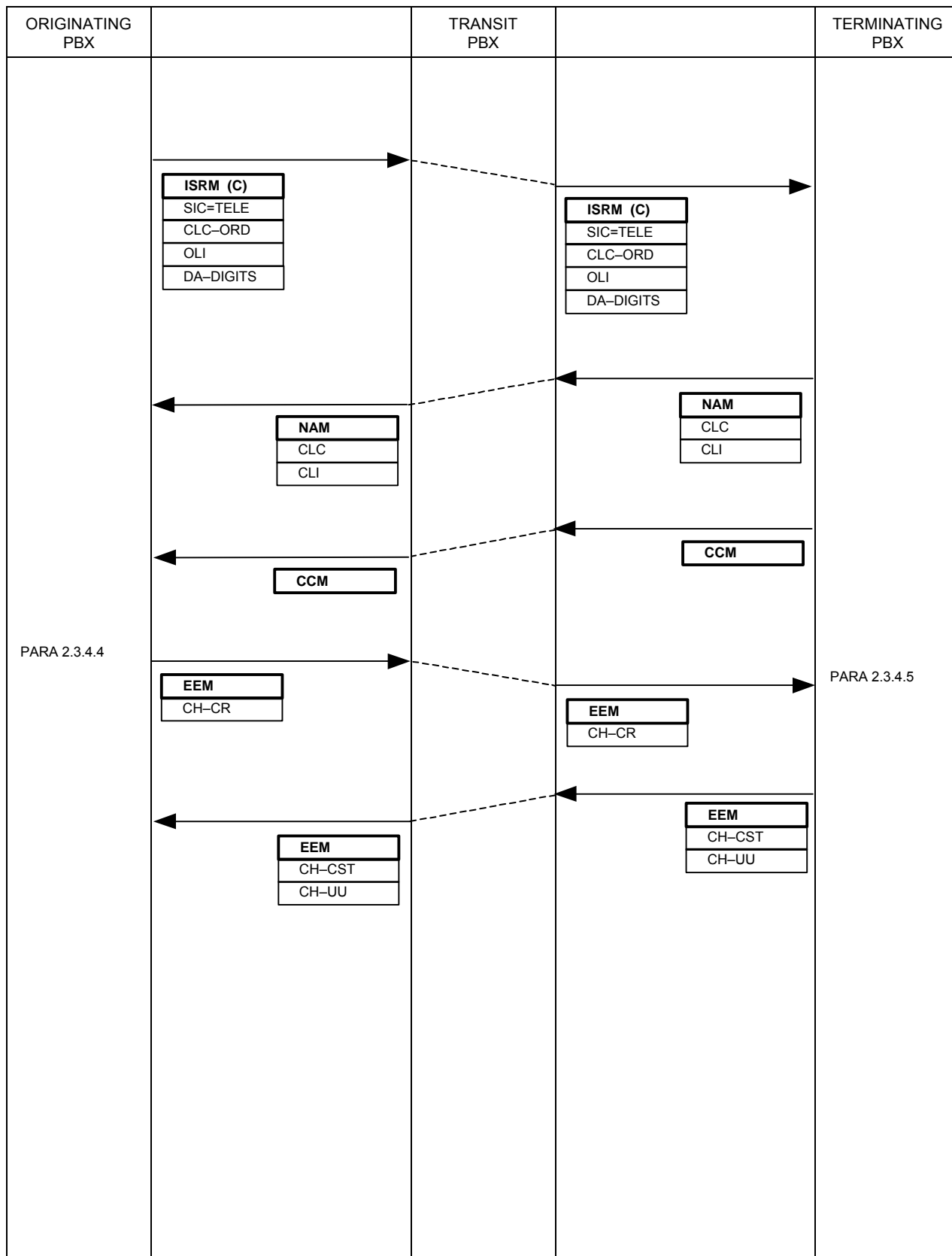

2.3.4.1 At any time after the connected stage of a call has been entered, the Terminating PBX may send the current call-cost details to the Originating PBX. In addition, the Originating PBX may request the current cost of the call from the Terminating PBX if it has been notified that charging is active (see 2.3.1).

Irrespective of how the call-cost data has been obtained by the Terminating PBX, call cost must be indicated in terms of units used. Since the capability to indicate the unit rate exists (see 2.3.3), it is always possible to express cost in terms of units even if the Terminating PBX has the information only in monetary form.

In addition to units used, the actual monetary value of the call may also be indicated where this information is available to the Terminating PBX. Where both forms of cost data are sent, they shall be equivalent within the limits of any conversion formula applied and the accuracy of any rounding process employed.

2.3.4.2 If the Terminating PBX wishes to inform the Originating PBX of any cost incurred on answer, the String CH-UU (Call Charging - Units Used) shall be included in the CCM. The String CH-CST (Call Charging - Cost) may also be included.

CH-UU conveys as its Parameter the number of units attributable to the call so far. CH-CST conveys as its first Parameter the number of monetary units attributable to the call so far, and an optional second Parameter may indicate the nature of those units. If the second Parameter is not present, a default may be assumed.

Unit cost may be indicated by the String CH-UR (see 2.3.3), if such information is available. In the absence of indication of unit rate, the Originating PBX will be unable to determine the monetary value of the cost from the indication of units used unless it is able to deduce the unit rate from other information (eg CLC and CLI).

2.3.4.3 If the Terminating PBX wishes to inform the Originating PBX of the current cumulative cost of the call after answer, an EEM shall be sent containing CH-UU and, optionally, CH-CST as in the case of cost on answer.

2.3.4.4 If an Originating PBX wishes to request the current cost of the call so far, an EEM containing CH-CR (Call Charging - Cost Request) shall be sent.

2.3.4.5 On receipt of CH-CR, the Terminating PBX shall respond with an EEM containing CH-UU and, optionally, CH-CST if charge data is available. If not, an EEM containing SU with a Parameter indicating CH-CR shall be returned.

2.3.5 CALL COST ON CALL TERMINATION – TERMINATING PARTY CLEARS FIRST

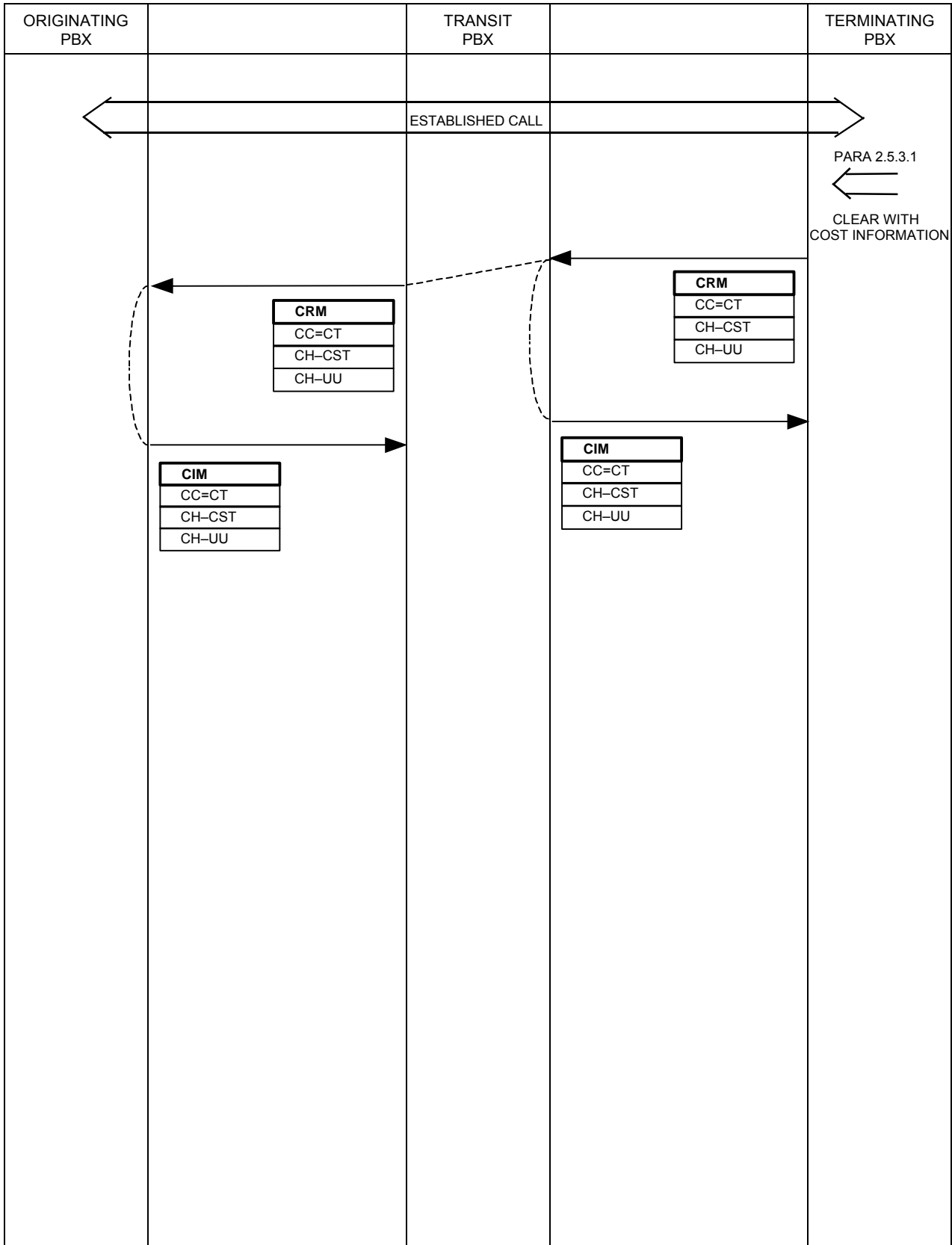

2.3.5 CALL COST ON CALL TERMINATION – ORIGINATING PARTY CLEARS FIRST

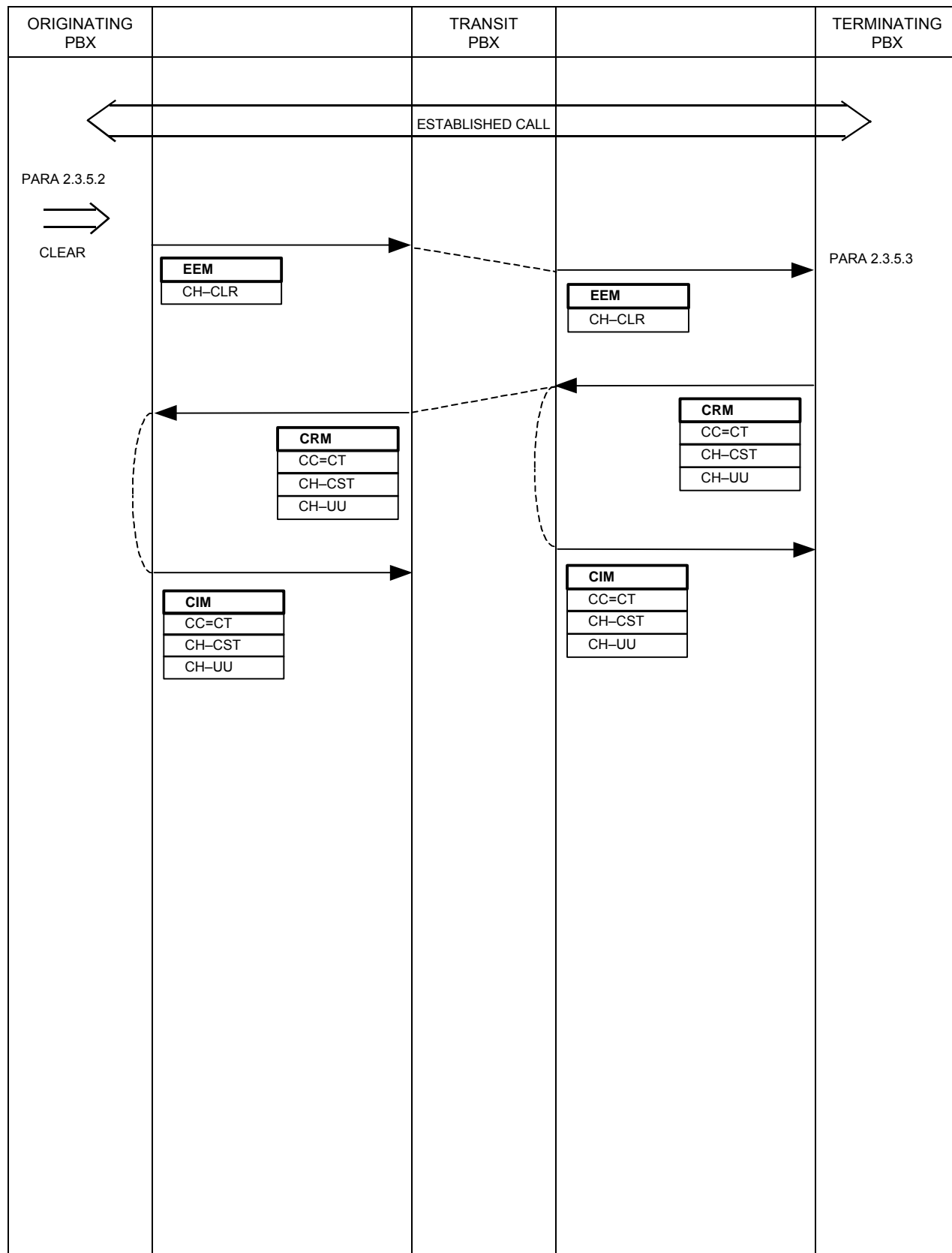

2.3.5.1 If the terminating party clears first and there is outstanding cost data to be sent, the String CH-UU and, optionally, CH-UR and/or CH-CST shall be included in the CRM containing Clearing Cause: CT. The clearing sequence shall continue in all other respects as for a Simple Call.

2.3.5.2 If the originating party clears first and the Originating PBX wishes to obtain further charging details, an EEM containing CH-CLR (Call Charge - Clear Request) shall be sent.

2.3.5.3 On receipt of an EEM containing CH-CLR, the terminating party shall be cleared as appropriate and the DPNSS 1 call cleared from the terminating party's PBX as described in 2.3.5.1 . If no charging data is available, an EEM containing SU with a Parameter of CH-CLR shall be returned instead.

2.3.5.4 If in response to sending CH-CLR, an EEM containing SU or SNU is received, or no EEM or CRM is received within a suitable time period, the DPNSS 1 channel shall be cleared by sending a CRM containing Clearing Cause: CT, and a CIM shall be expected in response.

3 COMPLIANCE

The Charge Reporting Supplementary Service is an optional part of DPNSS 1 and its provision on a PBX is a matter for negotiation between a customer and his supplier (see FOREWORD in SECTION 0 of this specification). This subsection may be used as an aid to those negotiations.

NOTE: Whilst the provision of this Supplementary Service is optional, if it is provided, compliance with certain features of the service becomes mandatory.

Compliance with the service is considered in terms of the function(s) to be performed by the PBX, ie Transit, End, or Branching, and the extent to which extensions or operators on the PBX can request the service.

The options available are given in TABLE 1. This table should be completed by a manufacturer to indicate PBX capability and by a purchaser to indicate PBX requirements.

TABLES 2 to 4 indicate the features that are required/provided at each PBX. The pre-printed "YES" indicates that the feature is a mandatory part of the service for that PBX function.

TABLE 1

PBX FUNCTION		APPLICABLE TABLE
Originating PBX		TABLE 2
Terminating PBX		TABLE 3
Transit PBX		TABLE 4

TABLE 2

COMPLIANCE TABLE FOR AN ORIGINATING PBX IN A NETWORK THAT SUPPORTS CHARGE REPORTING		
SERVICE VARIANT		COMMENT
Able to respond to a request for an Account Code?	YES	Give details
Able to request Call Cost during an established call?		
Able to request Call Cost on termination of an established call?		

TABLE 3

COMPLIANCE TABLE FOR A TERMINATING PBX IN A NETWORK THAT SUPPORTS CHARGE REPORTING		
SERVICE VARIANT		COMMENT
Able to indicate that charging is active?	YES	
Able to request Account Code details?		State use
Able to send Charge Rate (time basis)?		State when
Able to send Charge Rate (unit basis)?		State when
Able to respond to a request for Call Cost during an established call?	YES	
Able to respond to a request for Call Cost on termination of an established call?	YES	
Able to send unsolicited Call Cost details during an established call?		State circumstances
Able to send unsolicited Call Cost details on termination of an established call?		State circumstances

TABLE 4

COMPLIANCE TABLE FOR A TRANSIT PBX IN A NETWORK THAT SUPPORTS CHARGE REPORTING		
SERVICE VARIANT		COMMENT
Able to transit Charging Active indication?	YES	Inherent DPNSS 1 capability
Able to transit Account Code Request?	YES	Inherent DPNSS 1 capability
Able to transit Account Code Details?	YES	Inherent DPNSS 1 capability
Able to transit Charge Rate indication (time basis)?	YES	Inherent DPNSS 1 capability
Able to transit Charge Rate indication (unit basis)?	YES	Inherent DPNSS 1 capability
Able to transit request for Call Cost during an established call?	YES	Inherent DPNSS 1 capability
Able to transit request for Call Cost on termination of an established call?	YES	Inherent DPNSS 1 capability
Able to transit Call Cost details during an established call?	YES	Inherent DPNSS 1 capability
Able to transit Call Cost details on termination of an established call?	YES	Inherent DPNSS 1 capability

DIGITAL PRIVATE NETWORK SIGNALLING SYSTEM NO 1 (DPNSS 1)

**SECTION 41 - SUPPLEMENTARY SERVICE: NETWORK-ADDRESS EXTENSION
(NAE)**

CONTENTS

1	GENERAL	Page 2
2	NETWORK-ADDRESS EXTENSION WITHIN DPNSS 1	Page 3
	2.1 DEFINITION	Page 3
	2.2 DESCRIPTION	Page 3
	2.3 OUTLINE OF OPERATION	Page 3
3	COMPLIANCE	Page 5

HISTORY

Issue 1 - December 1989

Issue 2 - March 2001 - Specification renamed as DPNSS[188]

1 GENERAL

1.1 This Section details the signalling requirements of DPNSS 1 for the Network-Address Extension Supplementary Service.

1.2 Subsection 2 details the service within DPNSS 1.

1.3 Subsection 3 shows the Compliance.

1.4 The description is given in the form of explanatory text only.

1.5 Coding of Supplementary Information Strings is given in SECTION 4.

2 NETWORK-ADDRESS EXTENSION WITHIN DPNSS 1

2.1 DEFINITION

The NAE service allows the specification of an address beyond a particular destination within a DPNSS 1 network. This "subaddress" represents an entity which can be accessed via that destination. For example, NAE may be used to identify a process in a computer which is accessed via a DPNSS 1 data terminal. Subaddresses do not necessarily form part of the DPNSS 1 network numbering scheme and therefore, in general, subaddresses have significance only when considered in conjunction with a normal Destination Address.

2.2 DESCRIPTION

A call may be made to an entity beyond the DPNSS 1 network via a destination within the DPNSS 1 network. The normal DPNSS 1 Destination Address is used to route the call within the DPNSS 1 network, whereupon NAE may be used at the destination to perform further routing within another system in which some form of addressing is used.

In order to be consistent with OSI principles (reference ISO/DIS 8348/DAD 2), the NAE service allows a maximum-length subaddress of 40 decimal digits or 20 octets, where an octet is any 8-bit binary value. It is not, however, necessary for a PBX to support the full subaddressing capability of the service to claim compliance.

2.3 OUTLINE OF OPERATION

This facility is implemented by including the NAE destination String(s) (NAE-DC and NAE-DI) in an ISRM/SSRM sequence. The String Parameters convey the subaddress to be passed beyond the DPNSS 1 network via the equipment identified by the Destination Address.

Because NAE has no significance within the DPNSS 1 network, the service provides for transportation of data only within DPNSS 1. Definition of how NAE should be interpreted may be destination dependent, and is beyond the scope of this service.

In most cases, the String NAE-DC (NAE - Destination Complete) will suffice to convey the NAE data. However, for very long subaddresses, it may be necessary to split the NAE data into two Strings in order not to exceed the 45-octet limit on messages. On receipt, the subaddress is reconstructed by concatenation. Such Parameter splitting shall be used only where absolutely necessary, that is, where the NAE-DC String would otherwise be longer than 44 octets and hence not fit in an SSRM. Where splitting is necessary, the subaddress may be split at any point, with the first part being sent as the

Parameter to the String NAE-DI (NAE- Destination Incomplete) and the remainder sent as the Parameter to an NAE-DC String.

If NAE is received, but it is not appropriate to the destination or the Parameter value is not supported (eg it is too long or of the wrong type), the Terminating PBX may clear the call using a CRM containing the Clearing Cause: NAE-E (NAE - Error). Alternatively, it may allow the call to continue, in which case a NIM containing the String IG-SU with Parameter NAE-DC shall be sent prior to the NAM. Note that if a PBX supports only short subaddresses, it may unconditionally treat receipt of NAE-DI as an unsupported subaddress on the assumption that the total subaddress length must exceed that which is supported.

If the Originating PBX receives a NIM containing any of the following Strings:

IG-SU with Parameter NAE-DC,
IG-SU with Parameter NAE-DI,
IG-SNU with Parameter NAE-DC,
IG-SNU with Parameter NAE-DI,

it implies that the NAE data sent has not been acted upon. The PBX may then either maintain the call (optionally giving an appropriate indication to the originating party) or clear the call by sending forward a CRM with Clearing Cause: NT, and expecting a CIM in response.

The coding of the Parameters to the NAE-DI and NAE-DC Strings is given in SECTION 4. Note that it is possible to determine from the range of IA5 characters used in the Parameter coding whether the NAE data is in decimal or binary form. It follows that where NAE-DI and NAE-DC Strings are used together, the Parameter formats should be the same. Otherwise, one of the Strings shall be considered to contain a Parameter error, and shall be acted on accordingly.

3 COMPLIANCE SHEET FOR SUPPLEMENTARY SERVICE: NETWORK-ADDRESS EXTENSION

The Network-Address Extension Supplementary Service is an optional part of DPNSS 1 and its provision on a PBX is a matter for negotiation between a customer and his supplier (see FOREWORD in SECTION 0 of this specification). This Subsection may be used as an aid to those negotiations.

NOTE: Whilst the provision of this service is optional, if it is provided, compliance with certain features of the service becomes mandatory.

Compliance with the service is considered in terms of the function(s) to be performed by the PBX, ie Transit, End or Branching, and to the extent to which destinations on the PBX can use the service.

The options available are given in TABLE 1. This table should be completed by a manufacturer to indicate PBX capability and by a purchaser to indicate PBX requirements.

TABLES 2 to 4 indicate the features that are required/provided at each PBX. The pre-printed "YES" indicates that the feature is a mandatory part of the service for that PBX function.

TABLE 1

PBX FUNCTION		APPLICABLE TABLE
PBX which can add Destination Subaddresses to outgoing call requests		TABLE 2
PBX which has destinations to which subaddresses can be passed		TABLE 3
Transit PBX		TABLE 4

TABLE 2

COMPLIANCE TABLE FOR A PBX WHICH CAN ADD DESTINATION SUBADDRESSES ON OUTGOING CALLS		
SERVICE VARIANT		COMMENT
Able to add either decimal or binary form of subaddresses on outgoing calls?	YES	Specify capability
Able to react to indication that NAE has been ignored?		Specify action taken
Upper limit imposed on subaddress lengths?		Specify limit

TABLE 3

COMPLIANCE TABLE FOR A PBX WHICH HAS DESTINATIONS TO WHICH SUBADDRESSES CAN BE PASSED		
SERVICE VARIANT		COMMENT
Able to pass either decimal or binary form of subaddress to appropriate destinations?	YES	Specify capability
Upper limit imposed on subaddress lengths?		Specify limit

TABLE 4

COMPLIANCE TABLE FOR A TRANSIT PBX IN A NETWORK THAT SUPPORTS NETWORK-ADDRESS EXTENSION		
SERVICE VARIANT		COMMENT
Able to transit both forms of subaddress of any length?	YES	Inherent DPNSS 1 capability

DIGITAL PRIVATE NETWORK SIGNALLING SYSTEM NO 1 (DPNSS 1)

SECTION 42 - SUPPLEMENTARY SERVICE: CALL PARK

CONTENTS

1	GENERAL	Page 2
2	CALL PARK BETWEEN ORDINARY EXTENSIONS WITHIN DPNSS 1	Page 3
	2.1 DEFINITION	Page 3
	2.2 DESCRIPTION	Page 3
	2.3 OUTLINE OF OPERATION	Page 4
	2.3.1 Call Park Accepted by Connection	Page 5
	Call Park with Timeout at Called PBX	Page 6
	Call Park with Timeout at Calling PBX	Page 7
	2.3.2 Call Park At A Busy Extension, Accepted By Clear	Page 10
	Call Park at a Busy Extension, Accepted by Hold	Page 11
	2.3.3 Enquiry And Transfer With Call Park	Page 13
3	COMPLIANCE	Page 14

HISTORY

Issue 1 - December 1989

Issue 2 - March 2001 - Specification renamed as DPNSS[188]

1 GENERAL

- 1.1** This Section details the signalling requirements of DPNSS 1 for the Call Park Supplementary Service.
- 1.2** Subsection 2 details the service within DPNSS 1.
- 1.3** Subsection 3 shows the Compliance.
- 1.4** The description is given in the form of Message Sequence Diagrams (MSDs) followed by explanatory text.
- 1.5** The text is referenced from MSDs at appropriate points in the sequences.
- 1.6** Message contents for successful calls are shown in MSDs. Messages and their contents for alternative sequences (e.g., for unsuccessful calls) are detailed in the text.
- 1.7** Coding of the contents of messages is given in SECTION 4.

2 CALL PARK BETWEEN ORDINARY EXTENSIONS WITHIN DPNSS 1

2.1 DEFINITION

The Call Park Service allows a caller to be placed on "on-hook hold" at another extension, or, optionally, on immediate hold with warning given to the called party if the called party is busy. It also allows the calling party subsequently to transfer its own held party to the called party using signalling defined for the Three-Party Service in SECTION 13 of this specification.

2.2 DESCRIPTION

A calling party, with or without a held party, may request to be parked on another extension (the wanted extension).

If the wanted extension is free, it may be given an audible indication that there is a call incoming on that line, but this should be distinct from the normal incoming-call indication. The calling party shall be given an in-channel indication that the call is waiting at the wanted extension. At this point, if the calling party does have a call on hold, it may transfer it to the wanted extension, so that the original calling party becomes idle and its held party becomes the new calling party parked on the wanted extension.

The wanted party shall be given the choice of:

- i. Going off-hook and connecting to the calling party;
- ii. Going off-hook and making a new call (thus converting the situation to call park at a busy extension as described below);
- iii. Rejecting the waiting call;
- iv. Ignoring the waiting call and being rung after a short timeout.

If the wanted extension is not free, then acceptance of a Park Request is optional, depending on PBX design. However, if the Park Request is accepted, then the PBX must handle it in one of two ways. It may either treat it in the same way as Park at a free extension by waiting for the wanted party to become free, or the Park Request may be treated as a Call Offer Request, in which case Call Waiting Indication shall be given to the wanted party to indicate that another call is incoming to that line. In either case, the calling party shall be given an in-channel indication that the call is waiting at the wanted extension.

Once a parked condition has been established, the calling party may transfer any held party so that the original calling party becomes idle and its held party becomes the new calling party.

If the request is accepted as a call offer, the wanted party shall then be given the choice of:

- i. Going on-hook and being automatically re-rung;
- ii. Holding the existing call and answering the new call;
- iii. Rejecting the Call Waiting indication;
- iv. Ignoring the waiting call.

If the request is accepted by waiting for the wanted party to become free, then Call Waiting Indication shall be applied until the wanted party becomes free, after which the options for Call Waiting at a Free Extension shall become available.

Call Park is a calling-party service.

2.3 OUTLINE OF OPERATION

The signalling for establishing a parked condition is largely independent of the signalling used for transferring that condition to a held party. Thus, for reasons of clarity, transfer signalling, as defined for the Three-Party Service, has been omitted from the descriptions of the basic options available within Call Park. Since, however, the ability to transfer is an integral part of the service, the interaction of basic Call Park with Three-Party is detailed in paragraph 2.3.3.

The Call Park service is provided by the following signal sequences:

- 2.3.1 Call Park: - Accepted by Connection
 - With Timeout at Called PBX
 - With Timeout at Calling PBX.

- 2.3.2 Call Park: - At a Busy Extension, Accepted by Clear
 - At a Busy Extension, Accepted by Hold.

2.3.1 CALL PARK ACCEPTED BY CONNECTION

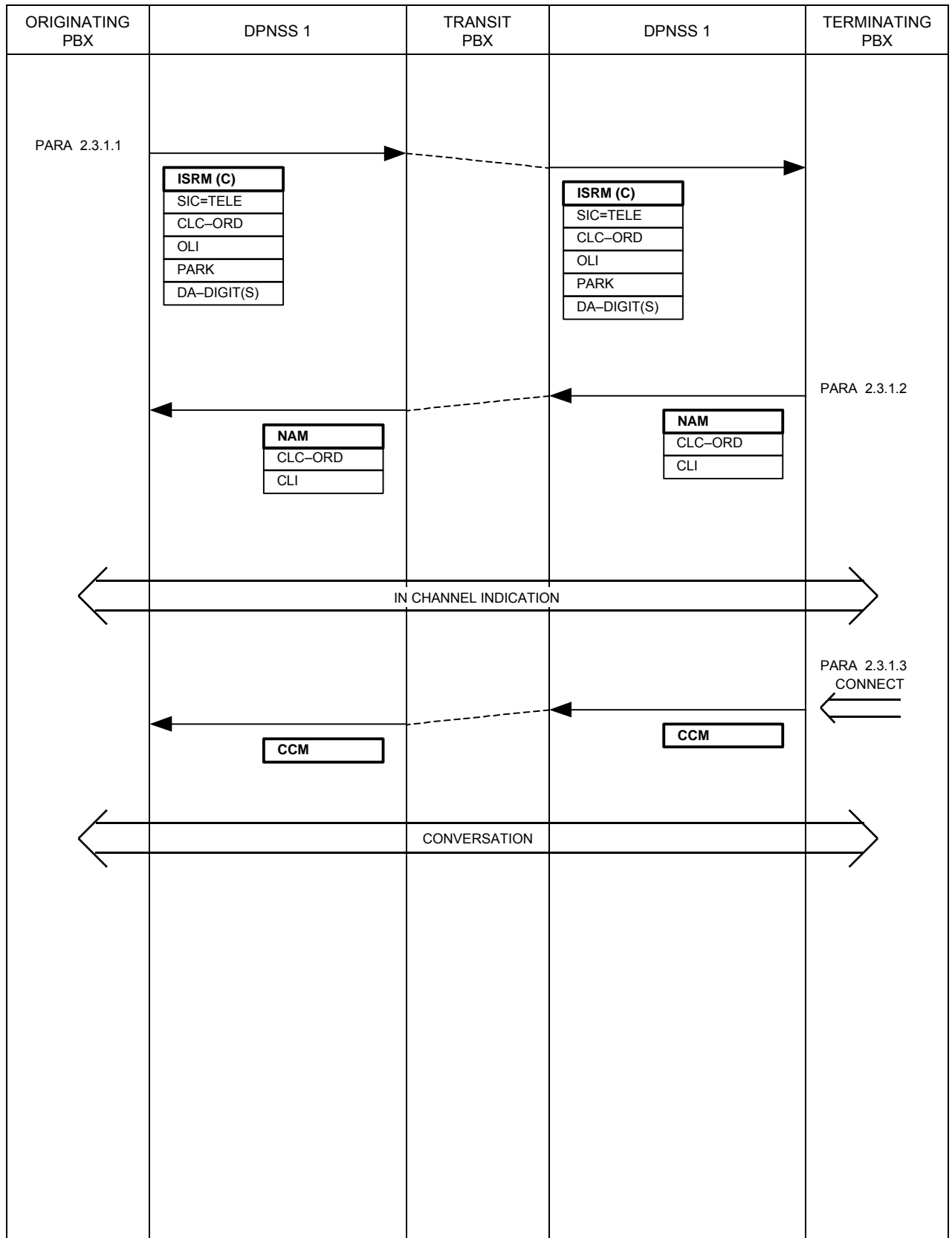

2.3.1 CALL PARK WITH TIMEOUT AT CALLED PBX

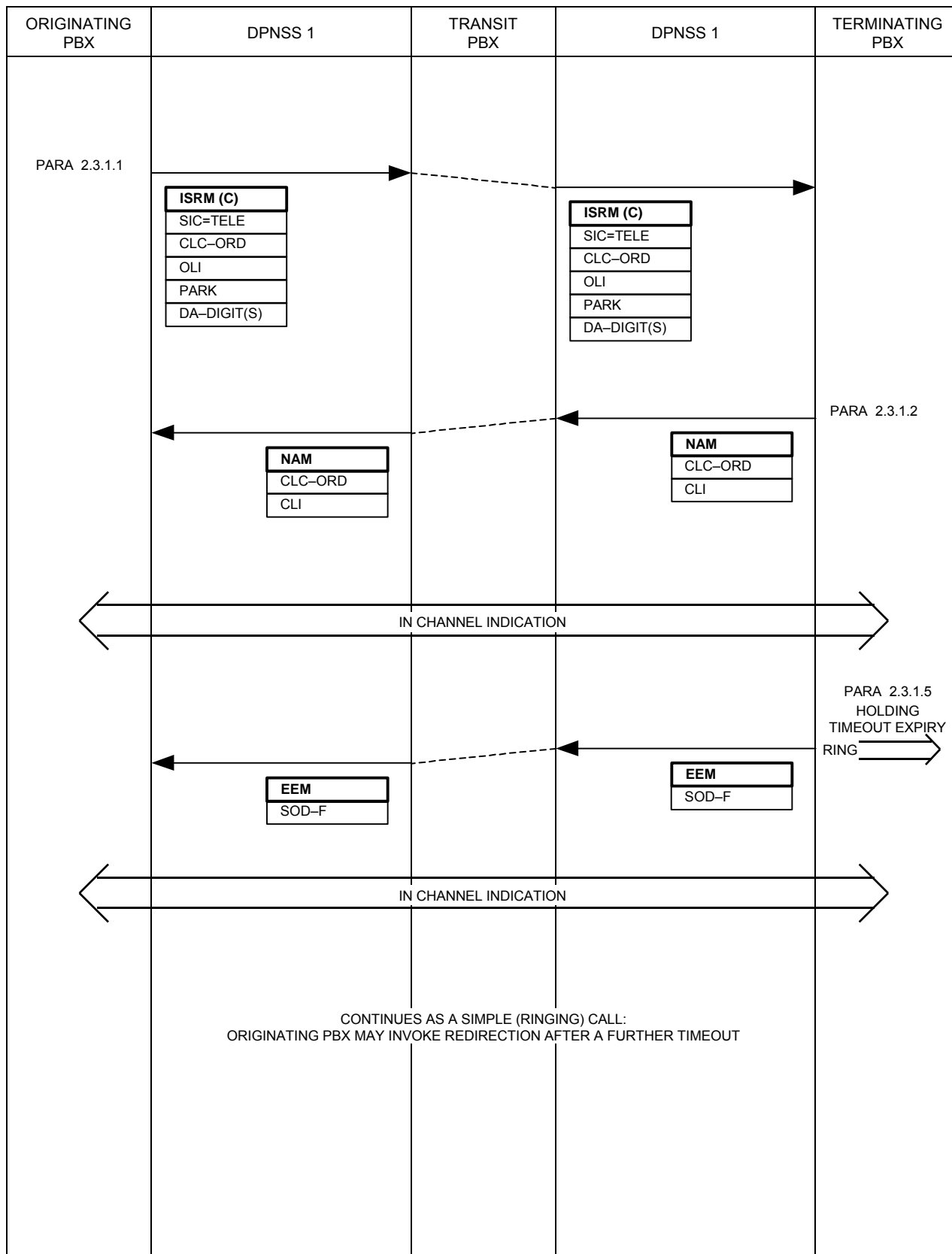

2.3.1 CALL PARK WITH TIMEOUT AT CALLING PBX

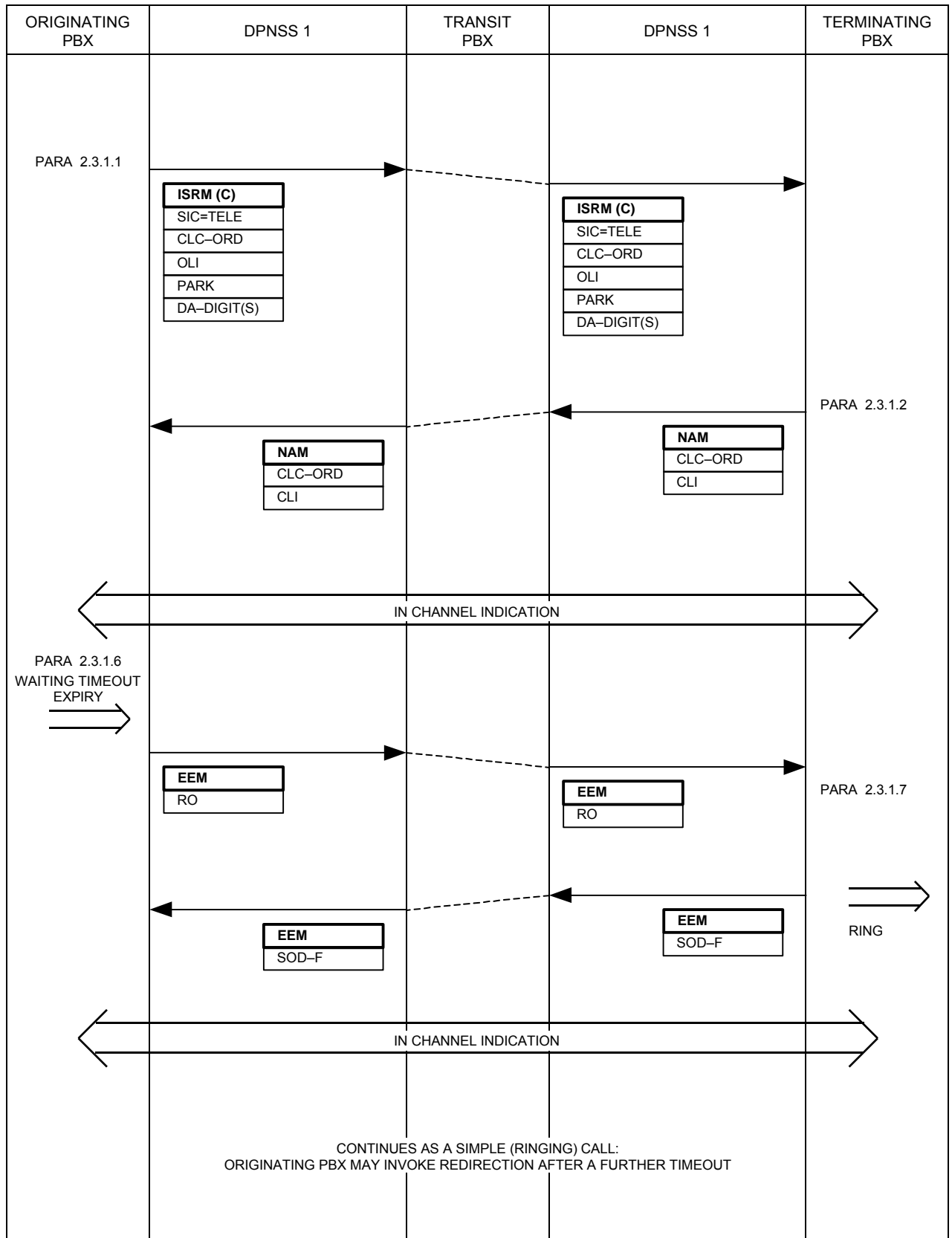

2.3.1.1 Subject to the originating extension having Call-Park capability, an ISRM shall be used to establish a connection to the wanted extension. The difference between this and a Simple Call ISRM is that it shall contain a Park Request (PARK).

2.3.1.2 If the Park Request is acceptable and either the wanted extension is free or the PBX can queue a parked call until the wanted extension becomes free, the call shall be placed on "on-hook hold" to the called extension. A displayable and/or audible indication may be given to the called party. The calling party shall be given an in-channel indication that the call is waiting at the called extension. A NAM containing the Called Line Category and Called Line Identity shall be returned to the Originating PBX.

If the request is unacceptable, a CRM containing the Clearing Cause: REJ shall be returned on the signalling channel, and a CIM expected in response.

In the event of the following call failure conditions:

- Number Unobtainable
- Address Incomplete
- Busy
- Congestion
- Subscriber Incompatible
- Subscriber Out of Service
- Incoming Calls Barred,

a CRM containing the appropriate Clearing Cause shall be sent, and a CIM expected in response.

2.3.1.3 The wanted party may accept the waiting call, ignore it and make another call, or accept another incoming call. A PBX may block the wanted extension from incoming calls whilst a parked call is waiting. If the wanted party becomes involved in another call, its PBX may choose to convert the situation to a Call Offer. If this is done, an EEM containing SOD-B shall be returned to the waiting party, the wanted party shall be given Call Waiting Indication and the procedures following 2.3.2.2 shall apply.

If the wanted party accepts the waiting call, a CCM shall be sent to the Originating PBX. A transmission path between the calling and wanted parties shall be established.

If the parked call is rejected by the called party, a CRM containing the Clearing Cause: REJ shall be sent on the signalling channel, and a CIM expected in response.

2.3.1.4 The originating party may clear at any time before answer by the called extension, in which case a CRM with Clearing Cause: CT shall be sent on the signalling channel. In addition, the Originating PBX may clear the call automatically using a CRM containing the Clearing Cause: CT, if the wanted party ignores the Call Waiting indication for a certain length of time.

If a CRM is received from the calling party at any time, a CIM shall be returned and any incoming call indication being applied to the wanted extension shall be removed.

2.3.1.5 While the call is waiting, the wanted party's PBX may start a timer, on expiry of which it shall ring the wanted party at the earliest opportunity. Once the wanted party is being rung, an EEM containing SOD-F shall be sent to the calling party, and ringing indication applied over the traffic channel. The call shall then proceed as a Simple (ringing) Call, with an option available to the calling PBX to perform Redirection after a further timeout. If Redirection is attempted, the signalling procedures detailed in SECTION 22 of this specification shall be used.

2.3.1.6 While the call is waiting, the calling party's PBX may start a timer, on expiry of which it may request that the wanted party be rung. Alternatively, a waiting user may request that the wanted extension be rung. In either case, an EEM containing RO shall be sent.

2.3.1.7 On receipt of an EEM containing RO, the wanted party shall be rung at the earliest opportunity. Once the wanted party is being rung, an EEM containing SOD-F shall be sent to the calling party, and ringing indication shall be applied over the traffic channel. The call shall then proceed as a Simple (ringing) Call, with an option available to the calling party's PBX to perform Redirection after a further timeout. If Redirection is attempted, the signalling procedures detailed in SECTION 22 of this specification shall be used.

2.3.2 CALL PARK AT A BUSY EXTENSION, ACCEPTED BY CLEAR

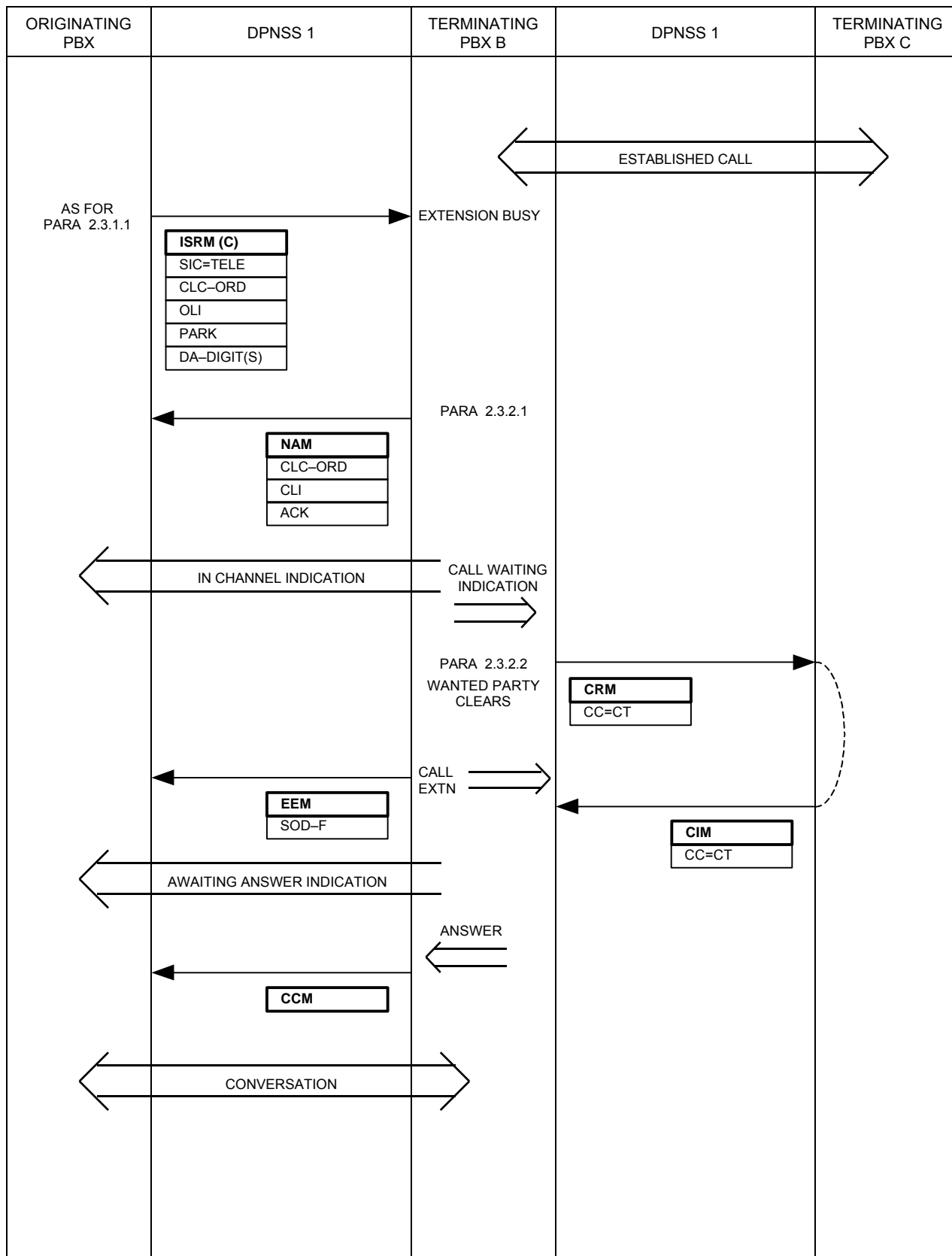

2.3.2 CALL PARK AT A BUSY EXTENSION, ACCEPTED BY HOLD

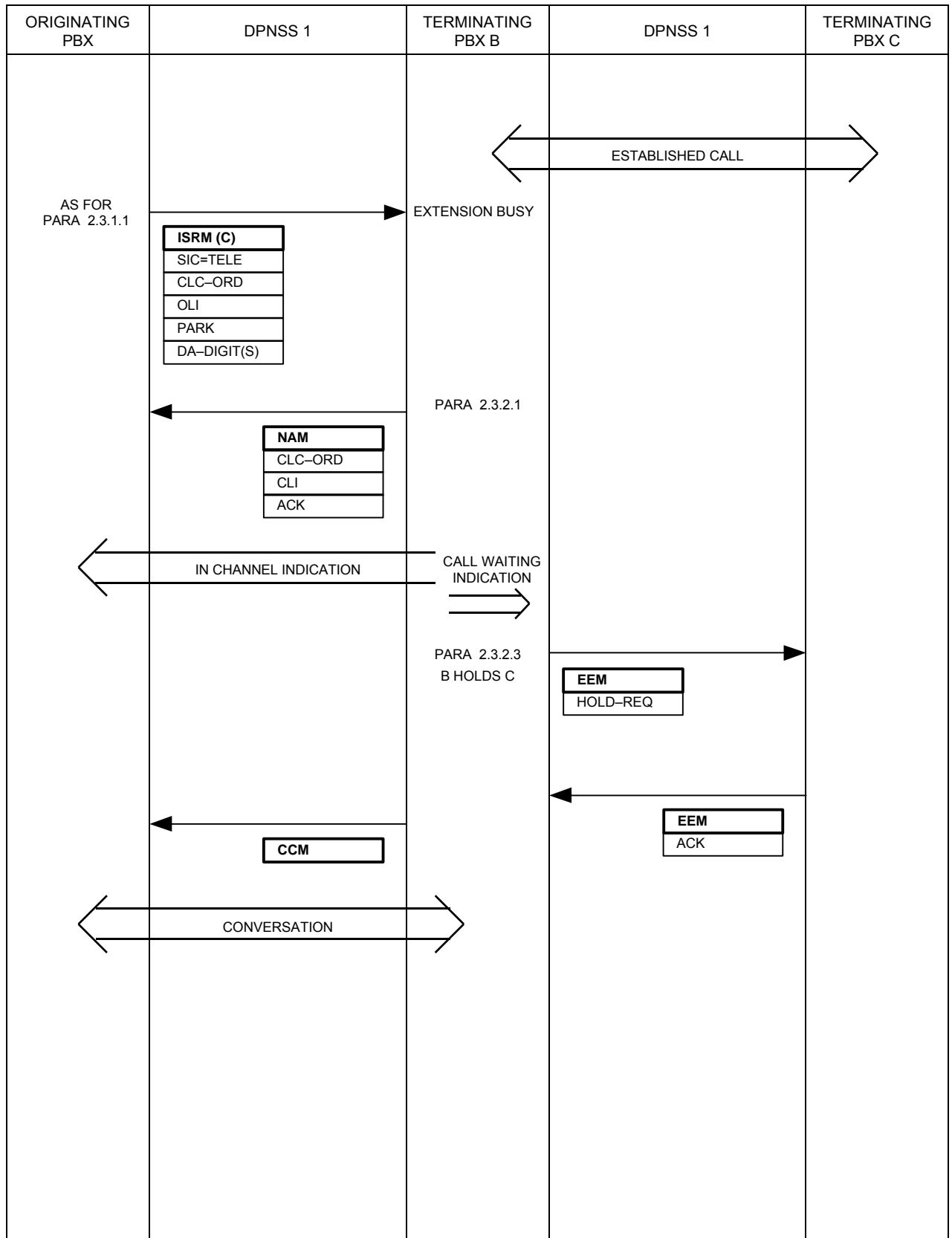

2.3.2.1 A Park Request is originated in the same manner as described in 2.3.1.1. If the called extension is busy and the Park Request is acceptable as a Call Offer, Call Waiting Indication shall be applied to the called extension and the calling party given an in-channel indication that Call Waiting Indication is being applied. A NAM containing the Called Line Category, Called Line Identity and Acknowledge shall be returned to the Originating PBX. Thus, the Calling PBX can determine whether the request has been accepted as a Call Offer or not by the presence of the String Acknowledge in the NAM.

If the request is unacceptable, a CRM containing the Clearing Cause: REJ shall be returned on the signalling channel, and a CIM expected in response.

If the called extension is in a state where it cannot receive calls (e.g., Out of Service) the call shall be cleared with a CRM containing the appropriate Clearing Cause (see SECTION 4, ANNEX 3).

2.3.2.2 The party receiving the Call Waiting indication may accept the call either by clearing the existing call or by placing it on hold. If the wanted party clears, a CRM shall be sent to the unwanted party as for a Simple Call clear-down sequence, and an EEM containing SOD-F shall be sent to the Originating PBX on the signalling channel.

The wanted party shall be re-called, and the waiting call treated as a Simple Call.

2.3.2.3 If the wanted party places its existing call on hold and accepts the waiting call, a CRM shall be sent to the Originating PBX. A transmission path between the calling and wanted parties shall be established. If the existing call is to an extension on another DPNSS 1 PBX, the Hold Supplementary Service procedures may be applied (see SECTION 12 of this specification). Where the PBX supports the Three-Party Service, further Three-Party procedures may be allowed following a successful hold.

If Call Waiting indication is rejected by the called party, a CRM containing the Clearing Cause: REJ shall be sent on the signalling channel, and a CIM expected in response.

2.3.2.4 The originating party may clear at any time before answer by the called extension, in which case a CRM with Clearing Cause: CT shall be sent on the signalling channel and a CIM expected in response.

In addition, the Originating PBX may clear the call automatically using a CRM containing the Clearing Cause: CT if the wanted party ignores the Call Waiting indication for a certain length of time and shall expect a CIM in response.

If a CRM is received from the calling party at any time, a CIM shall be returned and the Call Waiting Indication applied to the wanted extension shall be removed.

2.3.3 ENQUIRY AND TRANSFER WITH CALL PARK

2.3.3.1 If the extension requesting Park has a held party, PARK shall be included with ENQ in the ISRM, or with SCE in the RM or ERM. The request shall be handled by the Terminating PBX as a normal Park Request.

2.3.3.2 If the Park is accepted, the requesting PBX will receive a NAM. At this point, the held party may be transferred using the signalling defined for Transfer in SECTION 13. On receipt of an EEM containing TRFD, the PBX at which the call is parked shall return an EEM containing CLC and CLI. In addition, it shall contain the String CW, if the call is waiting at a busy extension, or PKD (Parked) if the call is on "on-hook hold" to the called extension.

If the call has been parked locally and then transferred to a remotely held party, the transferring PBX shall include CW or PKD, as appropriate, in the EEM containing CLC and CLI which it sends after the EEM containing TRFD.

2.3.3.3 If the held party clears before Transfer signalling is completed, the Enquiry Call may be automatically cleared by the requesting PBX by sending a CRM containing Clearing Cause: CT. A CIM shall be expected in response.

3 COMPLIANCE SHEET FOR SUPPLEMENTARY SERVICE: CALL PARK

The Call Park Supplementary Service is an optional part of DPNSS 1 and its provision on a PBX is a matter for negotiation between a customer and his supplier (see FOREWORD in SECTION 0 of this specification). This Subsection may be used as an aid to those negotiations.

NOTE: Whilst provision of this service is optional, if it is provided, compliance with certain features of the service becomes mandatory.

Compliance with the service is considered in terms of the function(s) to be performed by the PBX, i.e. Transit, End or Branching, and the extent to which operators or extensions on the PBX can request the service.

The options available are given in TABLE 1. This Table should be completed by a manufacturer to indicate PBX capability and by a purchaser to indicate PBX requirements.

TABLES 2 to 4 indicate the features that are required/provided at each PBX. The pre-printed "YES" indicates that the feature is a mandatory part of the service for that PBX function.

TABLE 1

PBX FUNCTION		APPLICABLE TABLE
PBX with operators or extensions, some of which can request the service		TABLES 2 and 3
PBX with operators or extensions, none of which can request the service		TABLE 2
Transit PBX		TABLE 4

TABLE 2

COMPLIANCE TABLE FOR A PBX WITH OPERATORS OR EXTENSIONS IN A NETWORK THAT SUPPORTS CALL PARK		
SERVICE VARIANT		COMMENT
Able to accept a Call Park Request on a free extension?	YES	
Able to accept a ring-out request?	YES	
Able to ring wanted extension after timeout?		
Able to accept a Call Park Request on a busy extension?		State if handled as Call Offer

TABLE 3

ADDITIONAL COMPLIANCE TABLE FOR PBXs WITH OPERATORS OR EXTENSIONS WHICH ARE ABLE TO REQUEST CALL PARK		
SERVICE VARIANT		COMMENT
Able to request that a call be parked on an extension on another DPNSS 1 PBX?	YES	
Able to generate a ring-out request?		
Able to invoke Redirection On No Answer?		

TABLE 4

COMPLIANCE TABLE FOR A TRANSIT PBX IN A NETWORK THAT SUPPORTS CALL PARK		
SERVICE VARIANT		COMMENT
Able to transit Call Park requests?	YES	Inherent DPNSS 1 Capability

DIGITAL PRIVATE NETWORK SIGNALLING SYSTEM NO 1 (DPNSS 1)

SECTION 43 - SUPPLEMENTARY SERVICE: CALL DISTRIBUTION

CONTENTS

1	GENERAL	Page 2
2	CALL DISTRIBUTION WITHIN DPNSS 1	Page 3
	2.1 DEFINITION.....	Page 3
	2.2 DESCRIPTION.....	Page 3
	2.3 OUTLINE OF OPERATION.....	Page 5
	2.3.1 Originator to Distributor.....	Page 7
	2.3.2 Investigation.....	Page 8
	2.3.3 Forwarding.....	Page 9
	2.3.4 Linked Into Queue.....	Page 12
	2.3.5 Free Notify.....	Page 14
	2.3.6 Call Set-Up.....	Page 16
	2.3.7 Unlinked from Queue.....	Page 18
	2.3.8 Originator Clears.....	Page 19
3	COMPLIANCE	Page 20

HISTORY

Issue 1 - December 1989

Issue 2 - March 2001 - Specification renamed as DPNSS[188]

1 GENERAL

- 1.1** This Section details the signalling requirements of DPNSS 1 for the Call Distribution Service.
- 1.2** Subsection 2 details the service within DPNSS 1.
- 1.3** Subsection 3 shows Compliance.
- 1.4** The description is given in the form of Message Sequence Diagrams (MSDs) followed by explanatory text.
- 1.5** The text is referenced from the MSDs at appropriate points in the sequences.
- 1.6** Message contents for successful calls are shown in the MSDs. Messages and their contents for alternative sequences (eg for unsuccessful calls) are detailed in the text.
- 1.7** Coding of the contents of messages is given in SECTION 4.

2 CALL DISTRIBUTION WITHIN DPNSS 1

2.1 DEFINITION

The Call Distribution Supplementary Service makes it possible to have calls automatically distributed among a group of associated users spread over more than one PBX.

2.2 DESCRIPTION

A number of stations (extensions, operator consoles, etc) may form a group in that calls may be directed at that group as if it were a single entity with any of the stations equally capable of receiving the call. Such a collection of stations shall be termed an Answer Group, and each station an Answer Station. The Answer Stations may be spread over more than one PBX. A collection of Answer Stations located on one PBX shall be called an Answer Point. Note that one Answer Point may service more than one Answer Station within the same Answer Group. See Fig. 1.

When a call is directed at an Answer Group, it is first routed to a Distributor PBX. The Distributor PBX controls the distribution of calls between Answering Points in the Answer Group. It may also be required to queue calls. The original call to the Distributor PBX is maintained throughout Call Distribution. The Distributor, using the algorithms described below, routes the call on to an Answer Point. The Answer Point controls distribution between the Answer Stations that it services.

It is possible when using this service to ensure that calls are presented at Answer Points in the same order as their arrival at the Distributor PBX. Note that this is possible only if the Distributor and Answer Point PBXs use the Call Indexing system (described from paragraph 2.3.4 onwards).

There may be more than one Distributor PBX in a network. An Answer Point may service more than one Distributor.

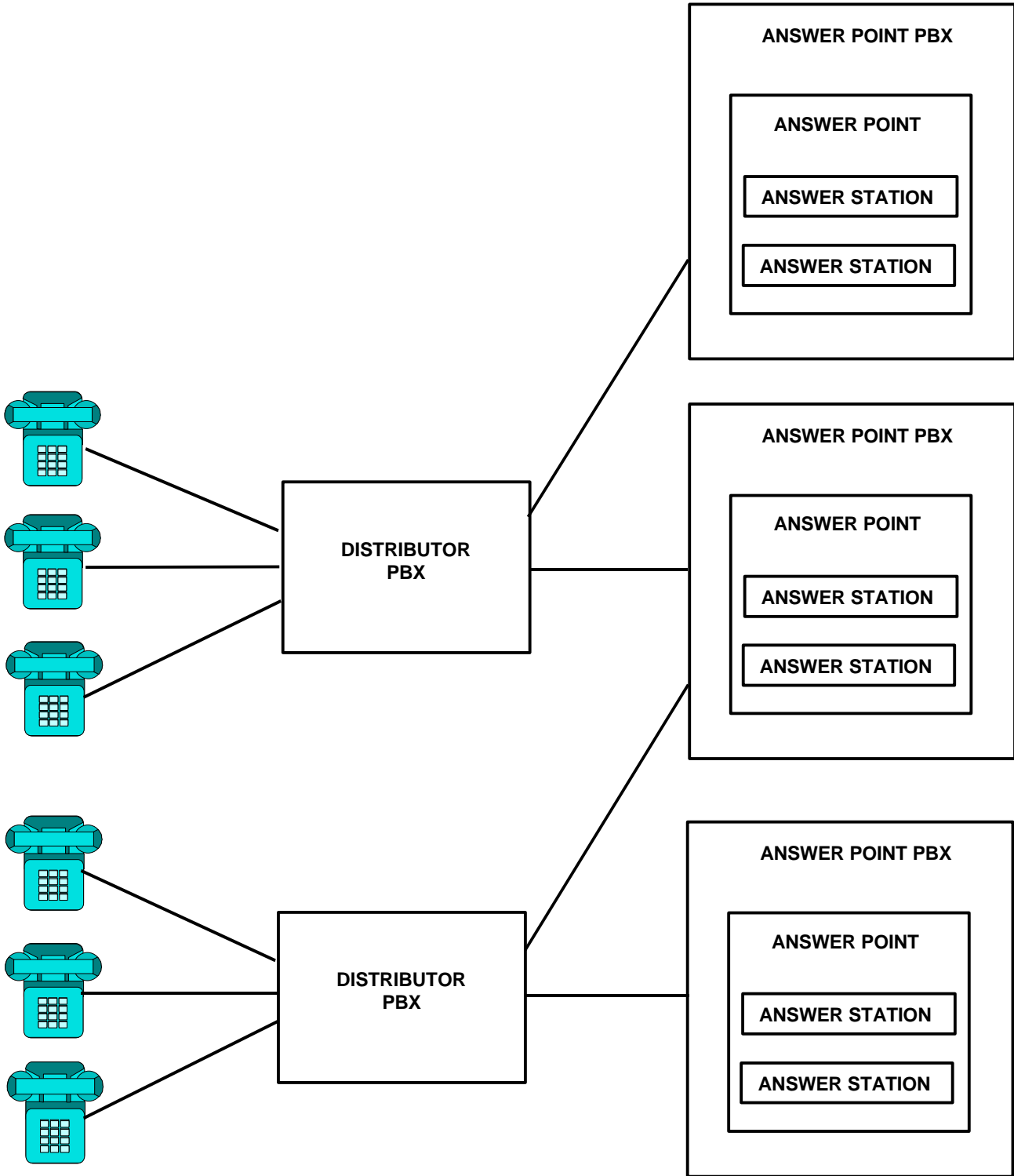

Fig. 1 – Example Configuration

2.3 OUTLINE OF OPERATION

This facility is implemented using the following separate signalling sequences.

2.3.1 Call Distribution Service - Originator to Distributor

When a call is to be made to an Answer Group, a path is first set up between the PBX of the originating extension and the Distributor PBX. The Distributor PBX can then take full control of the distribution. Thus, the only processing that is a mandatory requirement for the Originator PBX is the ability to establish a Simple Call.

NOTE: A Distributed Group indication is returned to the originator during Call Distribution so that the Route Optimisation Service (SECTION 19) may be initiated at a later stage by the Originating PBX, if supported.

2.3.2 Call Distribution Service - Investigation

The Distributor PBX can investigate the call loading of each Answer Point. This is done using the Extension-Status Service (SECTION 20). The information can then be used to determine the optimum Answer Point to handle the call.

2.3.3 Call Distribution - Forwarding

The Distributor PBX forwards the call to an Answer Point. The Distributor may or may not have previously invoked the Investigation phase in order to determine the optimum Answer Point. When forwarding the call, the Distributor indicates whether or not it has specifically chosen this Answer Point to take the call (following Investigation). If the Answer Point is busy and has not been specifically chosen for this call, it should refuse it.

If the Answer Point refuses the call for any reason, the Distributor may take one of the following actions. It must not allow the call to fail.

- a) Try an alternative Answer Point.
- b) Queue the call and request that Answering Points inform the Distributor when they are able to process the call.
- c) Repeat the Investigation and Forwarding process after a suitable delay.
- d) Present the call to an extension at the Distributor.

2.3.4 Call Distribution Service - Linked into Queue

If the Distributor PBX has to queue the call, it indicates this fact to all Answer Points. Any Answer Point that then becomes able to process the call will indicate this fact to the Distributor.

2.3.5 Call Distribution - Free Notify

When an Answer Point becomes available to handle a call, it sends an indication to the Distributor which then initiates Call Distribution - Call Set-Up.

2.3.6 Call Distribution - Call Set-Up

The call is routed to the Answer Point that has indicated that it has an Answer Station available.

2.3.7 Call Distribution Service - Unlinked from Queue

When a call has been successfully distributed, the Distributor PBX unlinks the call from its queue and indicates to all Answer Points that the call is no longer queued.

2.3.8 Call Distribution - Originator Clears

If the originating party clears at any stage during distribution, all information relating to that call must be cleared at the Distributor PBX and the Answer Points.

NOTE: The MSDs assume that none of the parties is on the Distributor PBX. If a party is on the Distributor PBX, the DPNSS 1 signalling between that party and the Distributor does not apply.

2.3.1 ORIGINATOR TO DISTRIBUTOR

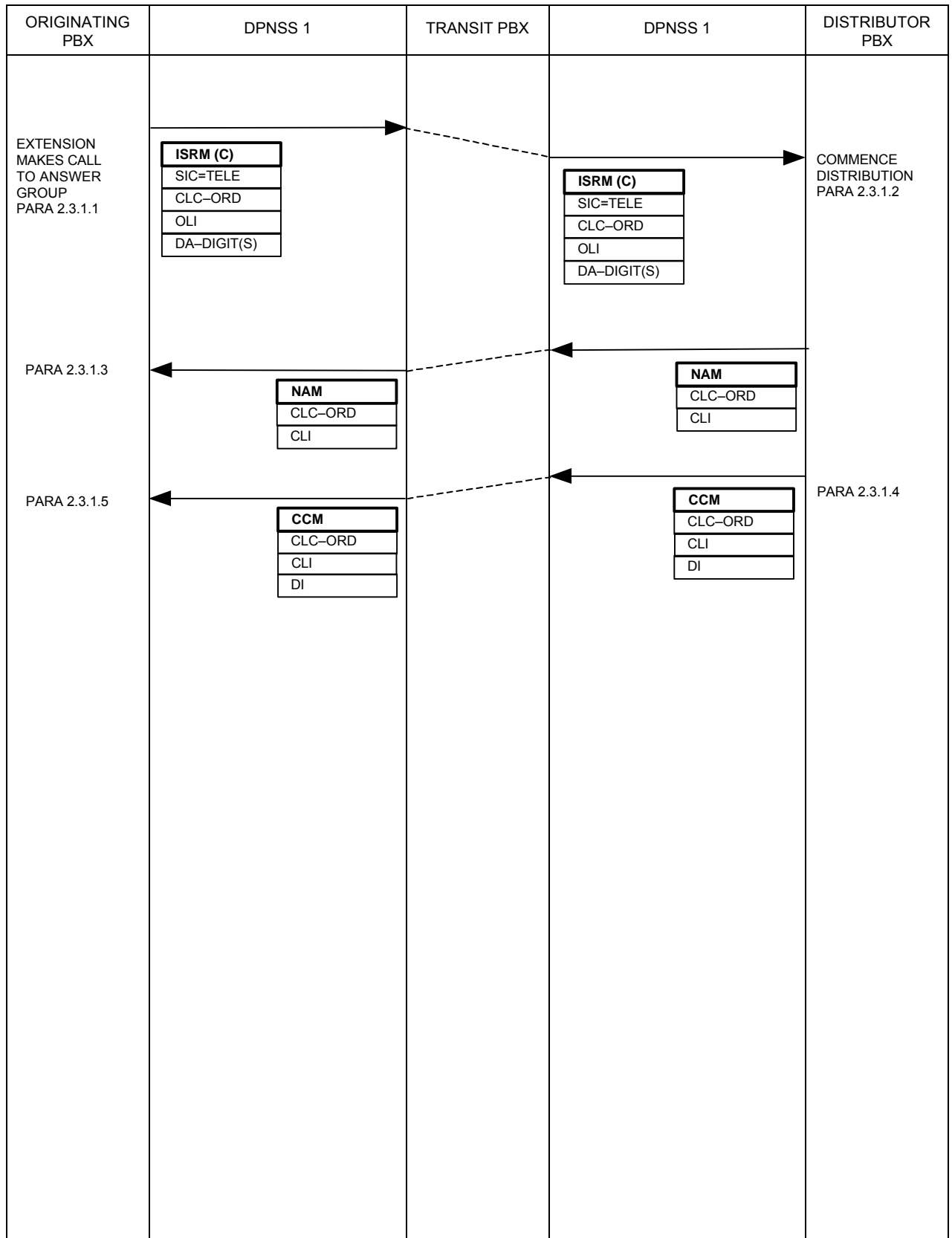

2.3.1.1 When a call is being made to an Answer Group, a connection has first to be established to a Distributor PBX. This is done using an Initial Service Request Message (ISRM) as for a Simple Call. A Number Acknowledge Message (NAM) is expected in response, as normal.

2.3.1.2 On receipt of an ISRM containing the DA of an Answer Group, if the Distributor PBX accepts the call, it returns a NAM containing CLC-ORD and Calling Line Identity (CLI). The CLC has a Distributed Group Parameter. The contents of the CLI are a copy of the received DA. Awaiting Answer indication is returned in the traffic channel. The Distributor PBX now invokes the distribution mechanism.

2.3.1.3 Receipt of a NAM indicates that Distribution is in progress and that Awaiting Answer indication is being returned in the traffic channel.

The Originating PBX may mark the receipt of the Distributed Group Parameter so as to cause the Route Optimisation Service (SECTION 19) to be invoked at a later stage.

2.3.1.4 The Distributor PBX (as a Transit) passes on the Call Connect Message (CCM) generated by the Answer Point PBX (see paragraph 2.3.3), including the Device Identity String (DI), if it is present.

2.3.1.5 The contents of the CCM may be used for display purposes.

2.3.2 INVESTIGATION

The Distributor PBX may investigate the call loading at the Answer Points. If so, the Extension-Status Service (SECTION 20) must be used. Information received can then be used to determine the optimum Answer Point to which to Forward the call.

2.3.3 FORWARDING

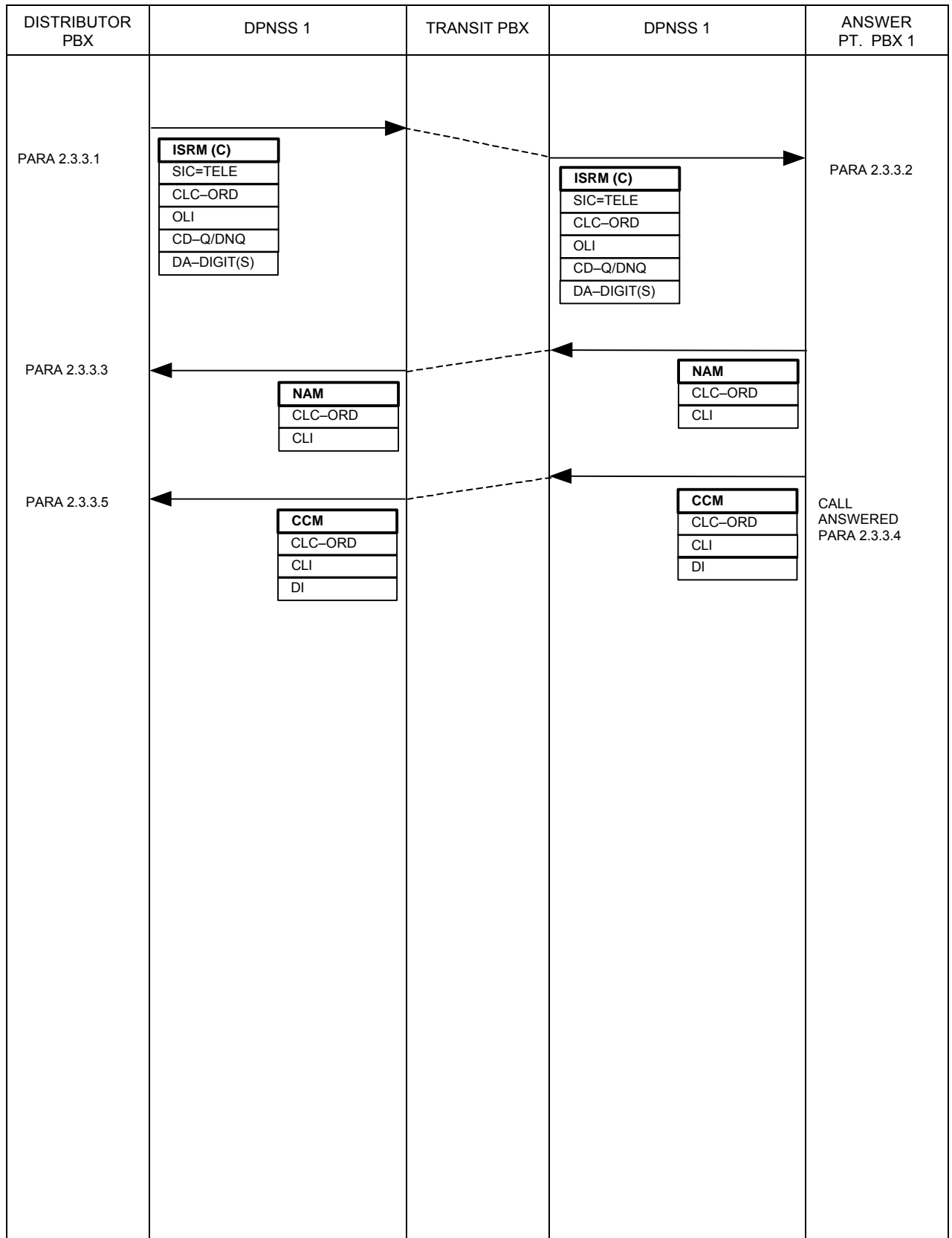

2.3.3.1 A call has arrived at the Distributor PBX and is to undergo Call Distribution. An ISRM is sent to an Answer Point PBX. The OLI in the ISRM is the same as that received from the Originating PBX, as is the CLC. The DA is that of the Answer Point. If an investigation algorithm has been used to determine the optimum Answer Point, a Call Distribution - Queue (CD-Q) String is included in the ISRM. If no investigation has been carried out, a Call Distribution - Do Not Queue (CD-DNQ) String is included in the ISRM.

If calls are already queued at the Distributor (so that it is known that there are no free Answer Stations) then the Forwarding mechanism can be omitted and the actions detailed in paragraph 2.3.3.3 b) can be taken.

2.3.3.2 If an ISRM containing a CD-Q String is received then the Answer Point may accept the call regardless of whether it is currently busy. If the call is accepted and the Answer Point is busy, it should queue the call locally. If a CD-DNQ String is received, the Answer Point should accept the call only if it is free. If it is not, a CRM is returned with Clearing Cause: BY.

If the call is accepted, the NAM is sent back. This contains the CLC and CLI of the Answer Point. Awaiting Answer indication is returned in the traffic channel.

2.3.3.3 If a NAM is received then the call has been accepted and so Distribution is complete. The Distributor now behaves as a Transit.

If a CRM is received, the Distributor can take one of the following actions:

- a) It can repeat the Forwarding process, but to a different Answer Point.
- b) It can place the call into a queue. This must be done when all Answer Points have been tried and found to be busy. The Linked-into-Queue mechanism is invoked.
- c) It may repeat the Investigation and Forwarding process after a suitable delay. (This might be done if an ISRM containing CD-Q has been sent and a CRM with Clearing Cause: CON received in response.)
- d) It may present the call to an extension located on the Distributor PBX itself.

2.3.3.4 When the call is eventually answered by one of the Answer Stations at the Answering Point, a CCM is sent. This contains CLI, CLC and, optionally, a Device Identity String (DI) defining the particular Answer Station that has taken the call.

2.3.3.5 The CCM and its contents are passed on by the Distributor PBX.

2.3.4 LINKED INTO QUEUE

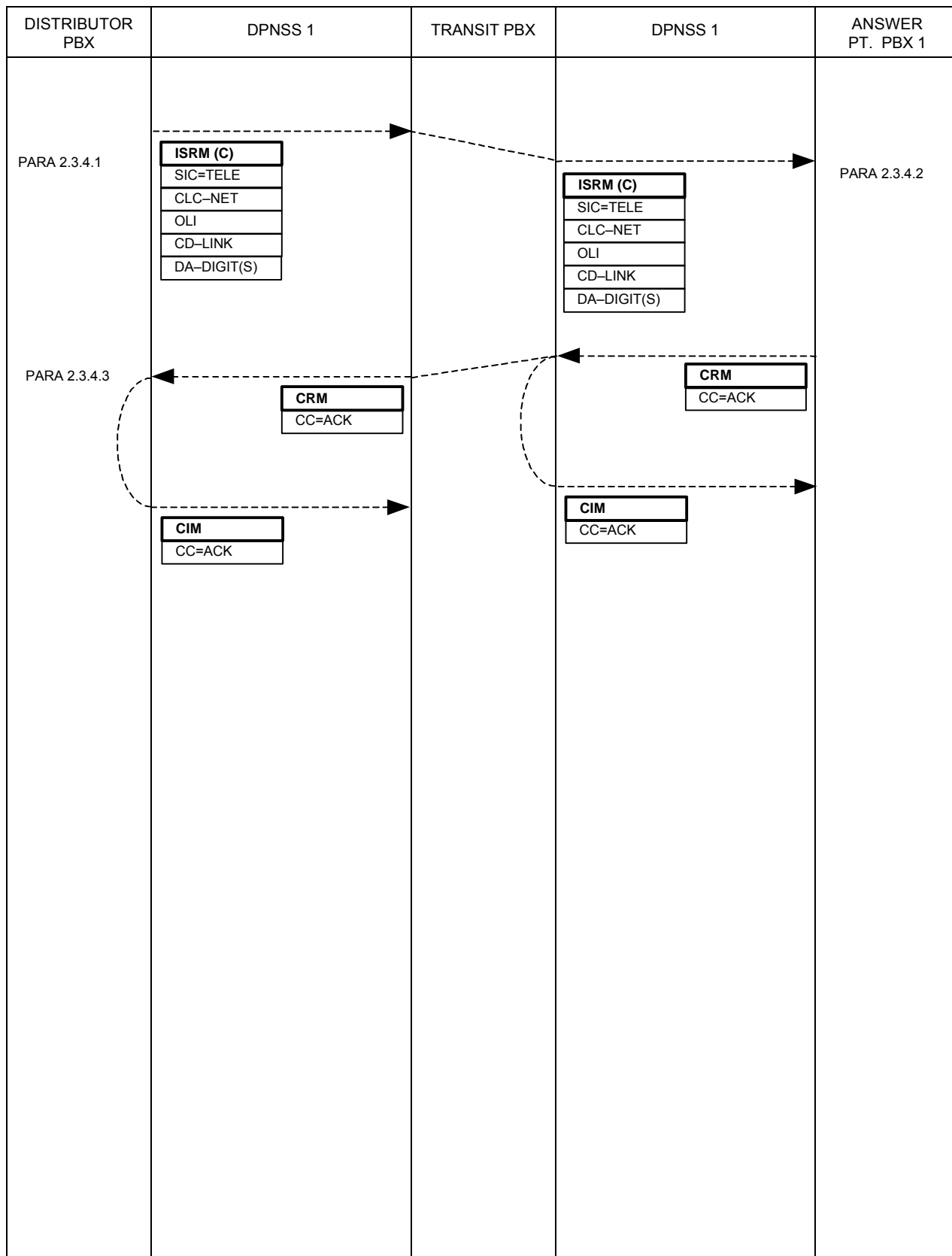

2.3.4.1 If a call has been linked into a queue at the Distributor PBX, an indication of that fact is sent to all the relevant Answering Points. This takes the form of an ISRM, sent on a Virtual channel, containing a Call Distribution - Linked String (CD-LINK). The optional Parameter to the CD-LINK string, Call Index, is a number used to identify that call while it is queued. The ISRM also contains CLC-NET, an OLI consisting of sufficient digits to enable routing back to the Distributor PBX and the DA of an Answer Point.

2.3.4.2 On receipt of an ISRM containing a CD-LINK String, the Answer Point PBX logs the fact that a call is queued at the Distributor PBX and returns a CRM with Clearing Cause: ACK. The OLI of the Distributor PBX must be stored so that it can be accessed later. If the Answer Point PBX operates a call-queueing facility, it may register the Distributed call in that queue. It may also store the associated Call Index for later use.

If the Call Index Parameter of a CD-LINK String matches one previously registered, a CRM with Clearing Cause: ACK is returned regardless. This situation might arise if the Distributor PBX has lost all information about Distributed calls in progress and has begun to re-allocate Call Indexes afresh. This will lead merely to some calls being processed out of order.

NOTE: If either the Distributor or the Answer Point PBX does not maintain/process Call Index then no guarantee can be given that calls will be presented to Answer Points in the same order as they arrived at the Distributor.

The Answer Point PBX monitors for when the Answer Point becomes able to process the call. This will be when the Answer Point has become free, or, possibly, when the Distributed call has come to the head of the queue.

2.3.4.3 Receipt of a CRM with Clearing Cause: ACK indicates that the call has been registered as being queued. If a CRM with Clearing Cause: CON or STU is received then the ISRM should be sent again after a suitable delay.

2.3.5 FREE NOTIFY

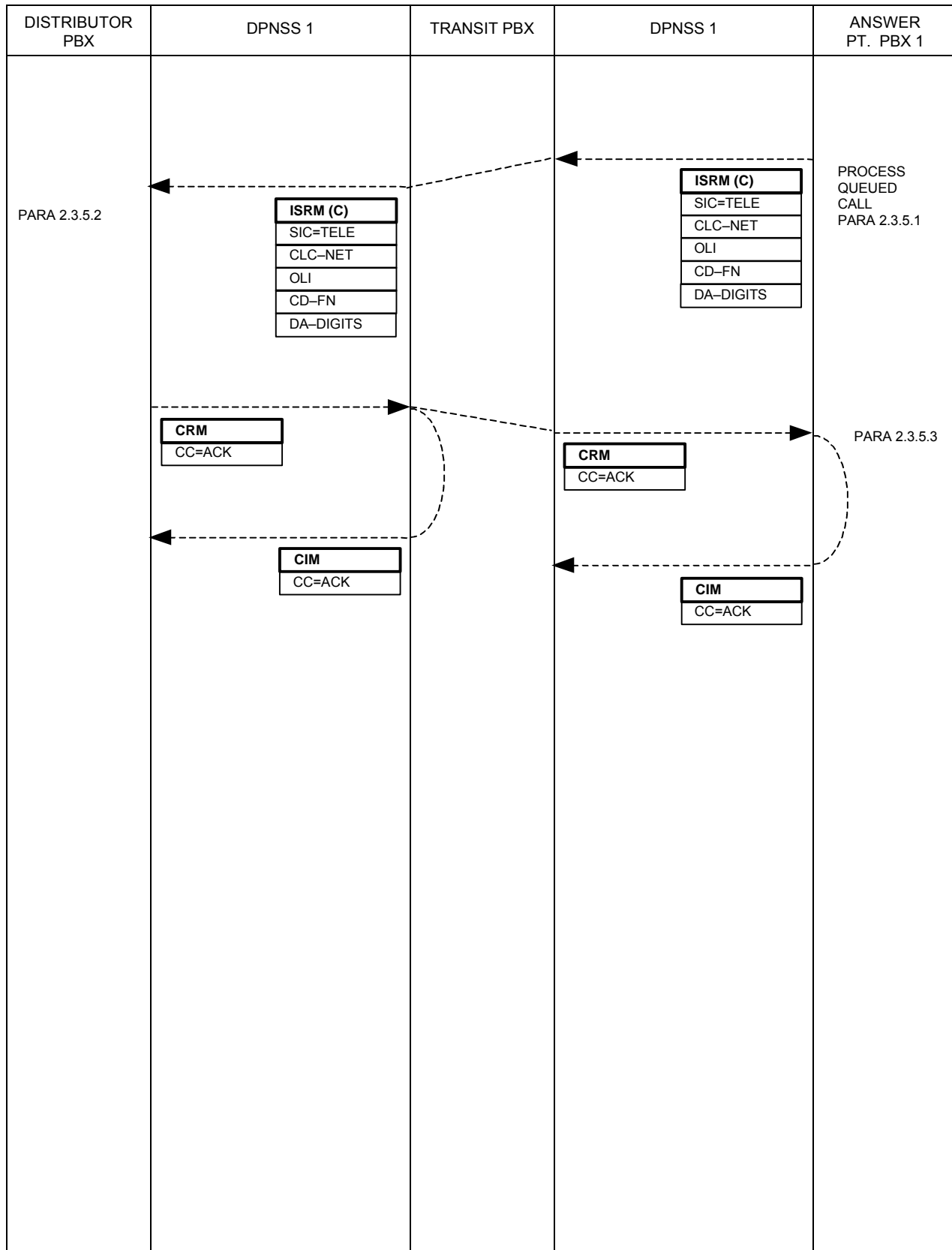

2.3.5.1 When the Answer Point has become free, or the Distributed call has come to the head of the local queue, an ISRM containing a Call Distribution - Free Notify String (CD-FN) is sent back to the Distributor PBX on a Virtual channel. If the Call Index was stored, it is sent as a Parameter to the CD-FN String. The OLI of the Answer Point is included, along with CLC-NET. The OLI stored as in paragraph 2.3.4.2 is used as the DA. A timer is started in expectation of a Call Distribution - Call Set-up. The Answer Station may also be blocked to increase the probability of its still being free when the Call Distribution - Call Set-Up is received.

2.3.5.2 If a call is registered that can be distributed, the ISRM with CD-FN String is acknowledged with a CRM with Clearing Cause: ACK. The Call Distribution - Call Set-Up mechanism is then initiated using the received OLI.

If there is a Call Index Parameter to the CD-FN String and this indicates a call that is already undergoing a Call Set-Up then a CRM with Clearing Cause: STU is returned.

If there is a Call Index Parameter to the CD-FN String, but it does not correspond to any of those registered, a CRM with Clearing Cause: FNR is returned.

If there is no Call Index Parameter to the CD-FN String then the Distributor assumes that the call at the head of its queue is being referenced.

2.3.5.3 A CRM with Clearing Cause: ACK implies that the Call Distribution - Free Notify was received, understood and is being processed. No action is required of the Answer Point as yet.

Receipt of a CRM with Clearing Cause: FNR indicates that the Distributor has lost all record of the call in question. It must therefore also be deleted at the Answer Point PBX. Any blocking is removed and the Answer Point goes on to process any other calls in its local queue (if one is maintained).

If the timer started in paragraph 2.3.5.1 times out before a Call Distribution - Call Set-Up is received or a CRM with Clearing Cause other than ACK or FNR is received, the Answer Point removes any blocking and goes on to process any other calls in the local queue (if one is maintained). The first call is left at the head of the queue so that it will be processed again later.

2.3.6 CALL SET-UP

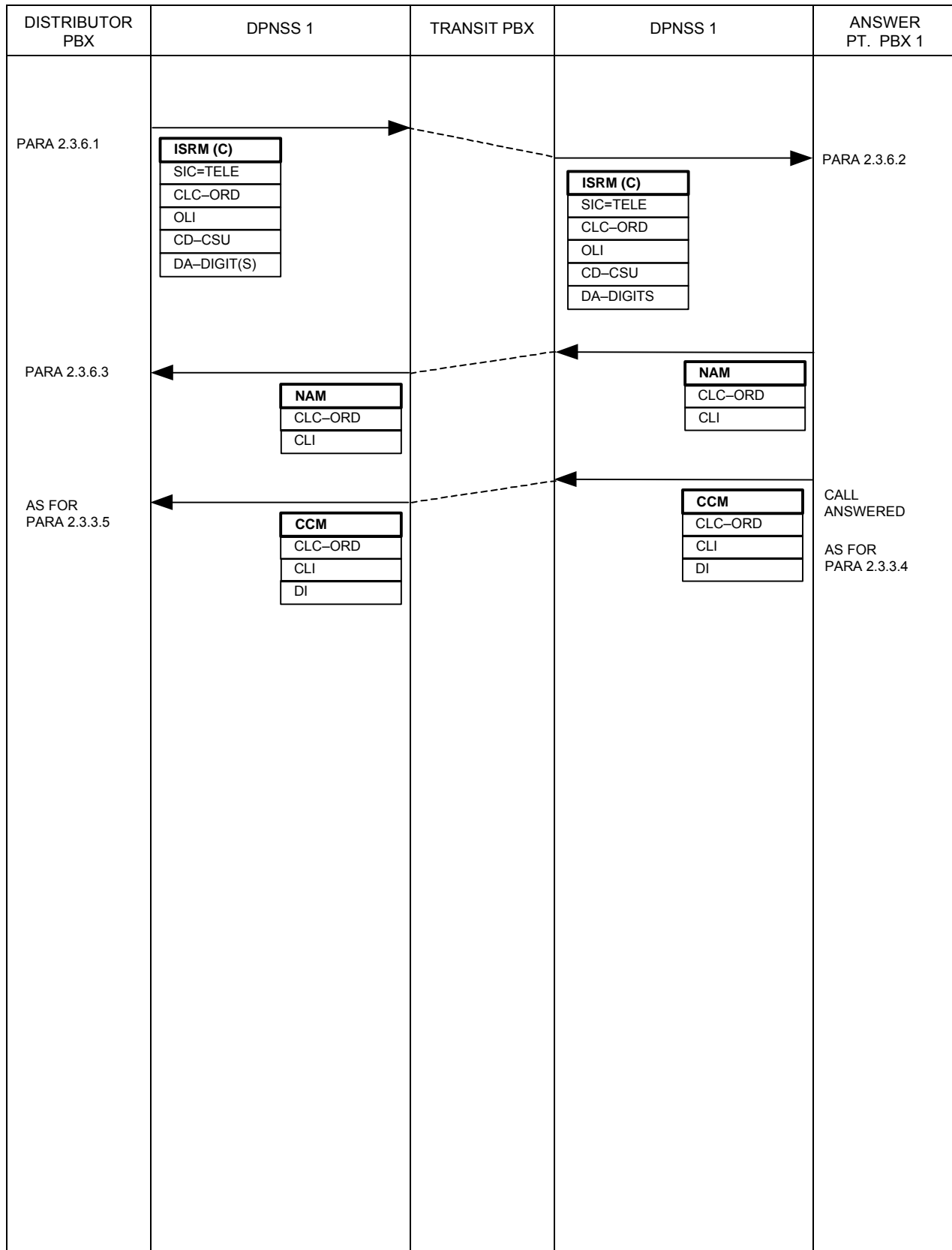

2.3.6.1 An Answer Point has indicated that it has an Answer Station that is able to process a call by sending a CD-FN String. An ISRM is therefore sent to that Answer Point containing a Call Distribution-Call Set-Up String (CD-CSU). If the CD-FN had a Call Index Parameter then the OLI of the call referenced by that Parameter is used. Otherwise, the OLI of the call at the head of the queue is used.

2.3.6.2 If an ISRM is received containing a CD-CSU String that is acceptable, the call overrides any blocking that may have been placed on an idle Answer Station. A NAM is sent back to indicate that the call has been accepted. This contains the CLI and CLC of the Answer Point. Awaiting Answer indication is returned in the traffic channel.

If all the Answer Stations have now become busy on a call (this may be on another Distributed call), a CRM is returned with Clearing Cause: BY and the PBX reverts to waiting for an Answer Station to become available (at which point another CD-FN will be sent).

2.3.6.3 If a NAM is received then the call has been accepted and so Distribution is complete. See paragraph 2.3.7 for action to be taken.

If a CRM is received with Clearing Cause: CON or STU, the Distributor should re-attempt the Call Set-Up process.

If a CRM with any other Clearing Cause is received, the Distributor PBX should revert to awaiting another Free Notify.

2.3.7 UNLINK FROM QUEUE

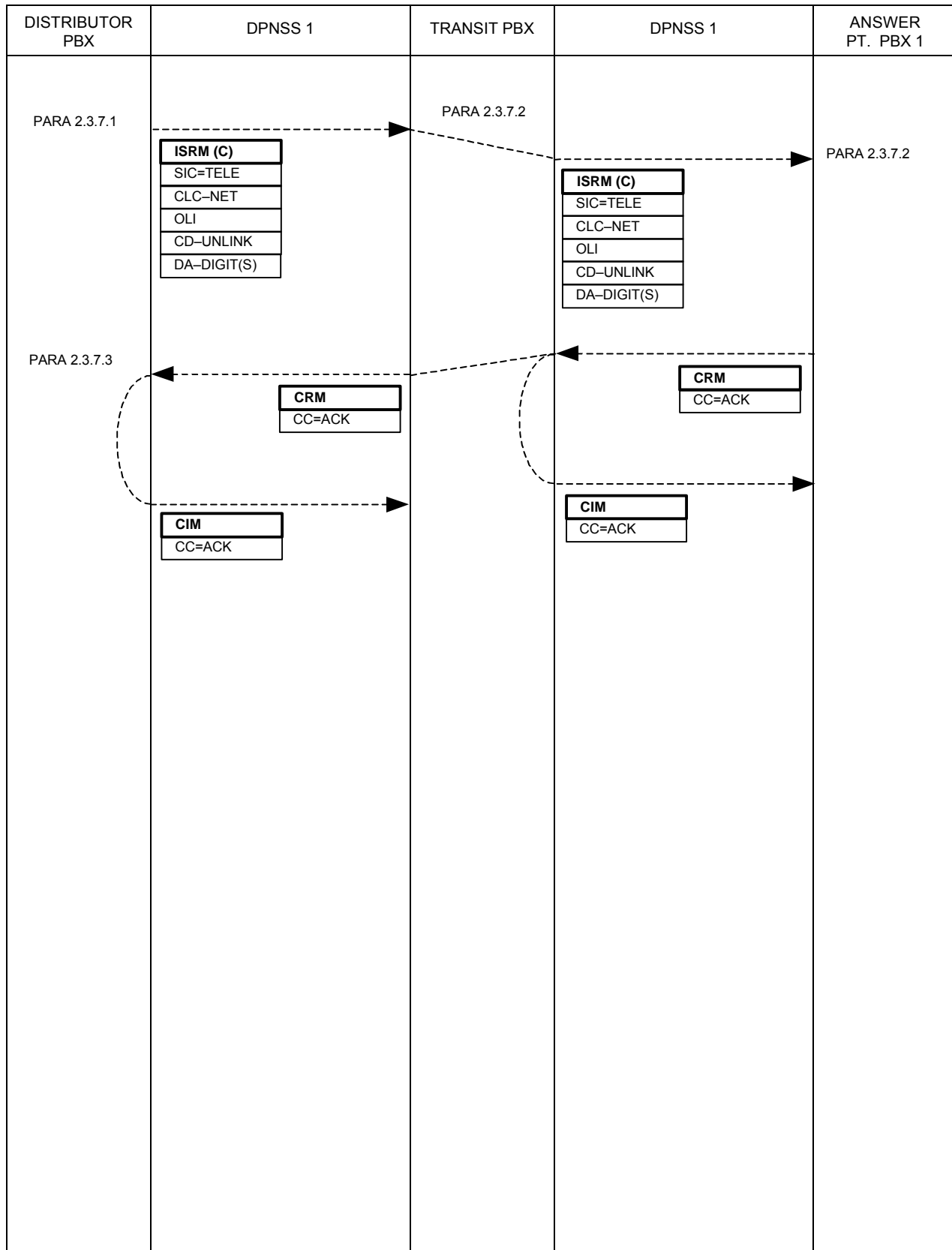

2.3.7.1 A call that is queued at the Distributor PBX has been successfully distributed. The call is therefore unlinked from the queue and an ISRM containing CD-UNLINK is sent on a Virtual Channel to each Answer Point.

2.3.7.2 Receipt of an ISRM with a CD-UNLINK String indicates to the Answer Point PBX that it no longer has to monitor the Answer Point for this particular call. If the CD-UNLINK has a Call Index Parameter and the Answer Point maintains a list of calls with Call Indices but none of these has the Index in question then a CRM with Clearing Cause: FNR is returned.

2.3.7.3 Receipt of a CRM with Clearing Cause: ACK indicates that the Answer Point PBX is no longer monitoring the Answer Point for that call.

If a CRM with Clearing Cause: CON or STU is received then the ISRM containing CD-UNLINK should be sent again after a suitable delay.

Receipt of a CRM with Clearing Cause: FNR implies that no further action is required on the part of the Distributor.

2.3.8 ORIGINATOR CLEARS

If the originator clears at any stage during the Forwarding process, the Distributor merely repeats the CRM on towards the Answer Point PBX. All data relating to the call stored at the Distributor is removed.

If the originator clears while the call is queued at the Distributor, it is removed from the queue and ISRMs are sent to all Answer Point PBXs containing the CD-UNLINK String (as described in paragraph 2.3.7).

If the originator clears during Call Set-Up, the Distributor repeats the CRM onwards to the Answer Point. The call is removed from any queue at the Distributor and ISRMs sent to all Answer Points containing the CD-UNLINK String.

3 COMPLIANCE SHEETS FOR SUPPLEMENTARY SERVICE: CALL DISTRIBUTION

The Call Distribution Supplementary Service is an optional part of DPNSS 1, and its provision on a PBX is a matter for negotiation between a customer and his supplier (see FOREWORD in SECTION 0 of this specification). This Subsection may be used as an aid to those negotiations.

NOTE: Whilst the provision of this service is optional, if it is provided, compliance with certain features of the service becomes mandatory.

Compliance with the service is considered in terms of the function(s) to be performed by the PBX, ie Transit, End or Branching, and the extent to which extensions on the PBX can request the service.

The options available are given in TABLE 1. This table should be completed by a manufacturer to indicate PBX capability and by a purchaser to indicate PBX requirements.

TABLES 2 to 7 indicate the features which are required/provided at each PBX. The pre-printed "YES" indicates that the feature is a mandatory part of the service for that PBX function.

It should be noted that the Call Distribution Service requires co-operation between the PBXs involved in a call, and unless all of the PBXs in a private network support the service, the extension users will experience inconsistent results.

TABLE 1

PBX FUNCTION		APPLICABLE TABLE
PBX that can Distribute calls.		TABLE 2 plus TABLE 3 and/or TABLE 4
PBX with operators or extensions some of which can accept Distributed calls.		TABLE 5
PBX with operators or extensions whose calls can be Distributed.		TABLE 6
Transit PBX.		TABLE 7

TABLE 2

COMPLIANCE TABLE FOR A PBX IN A NETWORK THAT IS CAPABLE OF FORWARDING CALLS		
SERVICE VARIANT		COMMENT
Able to Forward Distributed calls?	YES	
Able to repeat Call Distribution Forwarding on failure?	YES	
Able to present a failed call to an extension at the Distributor?		
Algorithm(s) used to determine optimum Answer Point.		Specify algorithm

TABLE 3

ADDITIONAL COMPLIANCE TABLE FOR A PBX IN A NETWORK THAT IS CAPABLE OF INVESTIGATING CALL LOADING		
SERVICE VARIANT		COMMENT
Able to investigate call loading?	YES	

TABLE 4

COMPLIANCE TABLE FOR A PBX IN A NETWORK THAT IS CAPABLE OF QUEUEING CALLS		
SERVICE VARIANT		COMMENT
Able to link Distributed calls into a queue and inform Answer Points?		
Able to process a Free Notify?	YES	
Able to unlink Distributed calls from queue and indicate such to Answer Points?	YES	
Able to initiate a Call Set-Up?	YES	
Able to process Call Index?		

TABLE 5

ADDITIONAL COMPLIANCE TABLE FOR A PBX WITH OPERATORS OR EXTENSIONS THAT CAN ACCEPT DISTRIBUTED CALLS		
SERVICE VARIANT		COMMENT
Able to provide call-loading information?	YES	
Able to inform Distributor PBX when Answer Point becomes free?	YES	
Able to accept Forwarding calls?	YES	
Able to accept Call Set-Up calls?	YES	
Able to maintain local queue and inform Distributor PBX when Distributed call is at head of queue?		
Able to process Call Index?		
Able to provide Device-Identity information?		

TABLE 6

ADDITIONAL COMPLIANCE TABLE FOR A PBX WITH OPERATORS OR EXTENSIONS WHOSE CALLS CAN BE DISTRIBUTED		
SERVICE VARIANT		COMMENT
Able to display Answer Point Device Identity?		
Able to log the receipt of Distributed Group Parameter to CLC in order to initiate Route Optimisation at later date?		

TABLE 7

COMPLIANCE TABLE FOR A TRANSIT PBX THAT SUPPORTS CALL DISTRIBUTION		
SERVICE VARIANT		COMMENT
Able to pass on messages relating to Investigation, Forwarding, Linking into Queue and Unlinking from Queue?	YES	Inherent DPNSS 1 capability

DIGITAL PRIVATE NETWORK SIGNALLING SYSTEM NO 1 (DPNSS 1)

SECTION 44 - SUPPLEMENTARY SERVICE: ROUTE CAPACITY CONTROL

CONTENTS

1	GENERAL	Page 2
2	ROUTE CAPACITY CONTROL SERVICE WITHIN DPNSS 1	Page 3
	2.1 DEFINITION.....	Page 3
	2.2 DESCRIPTION.....	Page 3
	2.3 OUTLINE OF OPERATION.....	Page 3
3	COMPLIANCE	Page 7

HISTORY

Issue 1 - January 1995

Issue 2 - March 2001 - Specification renamed as DPNSS[188]

1 GENERAL

1.1 This Section details the signalling requirements of DPNSS 1 for the Route Capacity Control Supplementary Service.

1.2 Subsection 2 details the service within DPNSS 1.

1.3 Subsection 3 shows the Compliance.

1.4 The description is given in the form of Message Sequence Diagrams (MSDs) followed by explanatory text.

1.5 The text is referenced from MSDs at appropriate points in the sequences.

1.6 Message contents for successful calls are shown in MSDs. Messages and their contents for alternative sequences (eg for unsuccessful calls) are detailed in the text.

1.7 Coding of the contents of messages is given in SECTION 4.

2 ROUTE CAPACITY CONTROL SERVICE WITHIN DPNSS 1

2.1 DEFINITION

The Route Capacity Control Service allows a call to be progressed over a route that is considered to be congested, by utilising additional capacity associated with that route.

The primary application of this service is in a VPN where there is additional capacity available between two switching points over and above that to which a private network operator has subscribed for normal traffic. Calls that make use of such additional capacity to override congestion may incur additional cost. Invocation of the feature may be limited to authorised users.

Although described in terms of a VPN, the service could also be offered in a PBX network, with Transit PBXs taking the place of the VPN.

2.2 DESCRIPTION

When congestion is encountered on a VPN route on which there is additional capacity, the VPN may itself override the congestion by using the additional capacity, or it may pass an indication back that additional capacity is available and allow the decision whether or not to invoke override to be left to a PBX.

Override may be invoked automatically on behalf of a user, or the user may be given an opportunity to decide whether or not override should take place.

Where override may be invoked at an Originating PBX, the manner in which the user can influence whether or not override takes place is PBX dependent.

Where override may be invoked either at a Transit PBX, or in a VPN, the user is given an indication during call set-up that override is available. The user will hear an in-band tone or announcement which will be run in association with a timeout. Whilst the timeout is running the caller may clear to avoid using the additional capacity, otherwise the caller may allow the timeout to expire and cause the call to progress using the additional capacity.

2.3 OUTLINE OF OPERATION

The Route Capacity Control Supplementary Service is specified by the following signalling sequences:

2.3.1 Route Capacity Control - Override invoked by a VPN

2.3.2 Route Capacity Control - Override invoked by a PBX

2.3.1 ROUTE CAPACITY CONTROL – OVERRIDE INVOKED BY A VPN

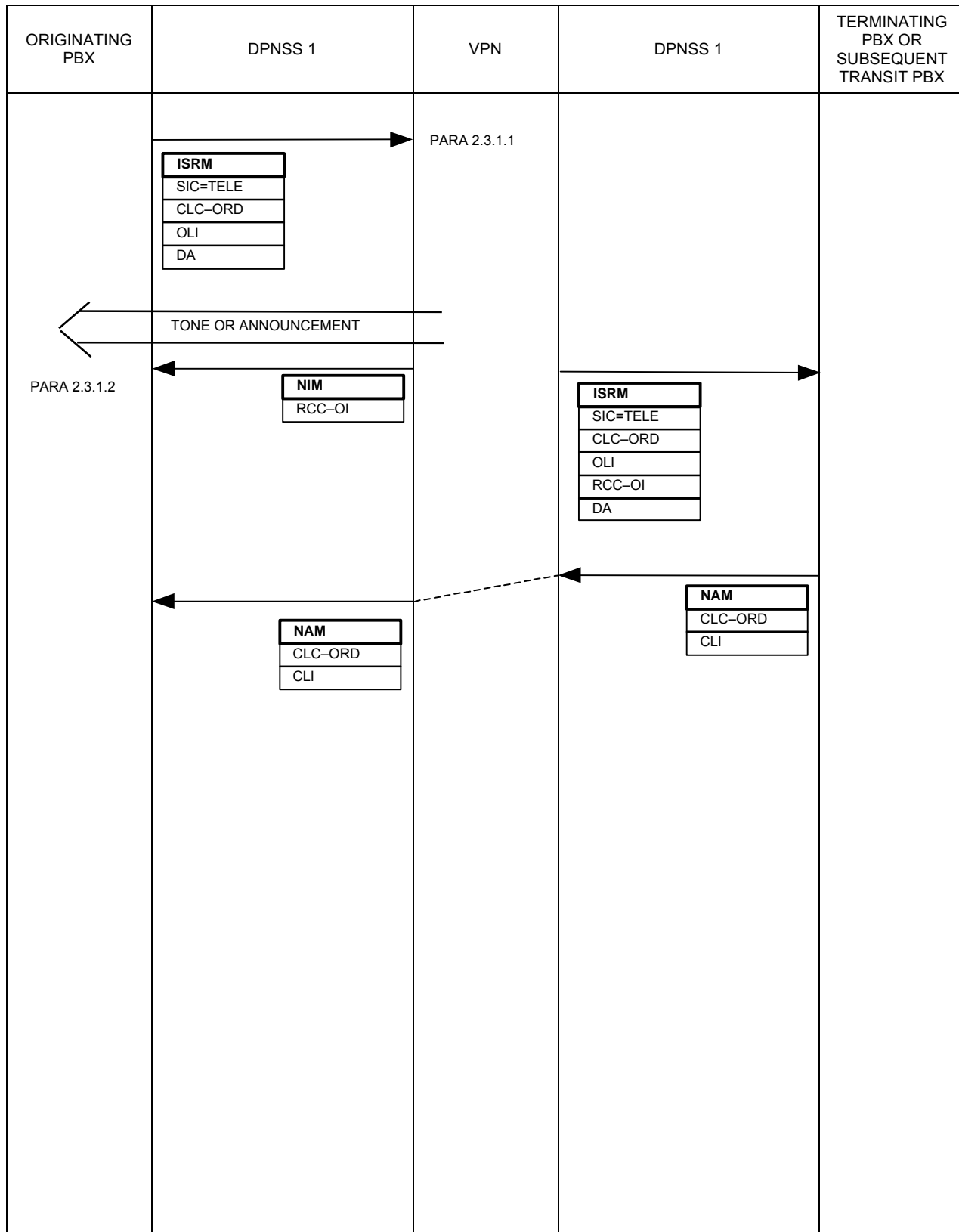

2.3.1.1 If a VPN encounters congestion on a route on which additional capacity can be made available, then, depending on the network configuration, it shall either clear the call backwards indicating that additional capacity is available as described in Paragraph 2.3.2.1, or it shall invoke override on behalf of the calling user.

If override is to be invoked, it shall either be invoked immediately, or after a delay during which the calling user is given an in-band indication that override is about to be invoked. If the calling user does not wish override to take place then the user may clear during the delay period resulting in the call being cleared forward.

The manner in which override is invoked by a VPN is implementation dependent but may be influenced by the type of call set-up being attempted.

If the additional capacity is to be used, the VPN shall route the call forward by choosing one of the additional channels. On sending forward the ISRM on the selected channel, the VPN shall add the String RCC-OI and it shall also return a NIM containing the String RCC-OI to indicate that override has been invoked.

The presence of RCC-OI in the ISRM will automatically override any further congestion encountered on a route where override is supported as described in paragraph 2.3.2.3.

2.3.1.2 Receipt of a NIM containing RCC-OI may be used by the Originating PBX for any appropriate purpose. For example, it may be used, to give an indication to the calling user or, to clear the call forwards if the Originating PBX determines that the calling user is not authorised to override congestion.

2.3.2 ROUTE CAPACITY CONTROL – OVERRIDE INVOKED BY A PBX

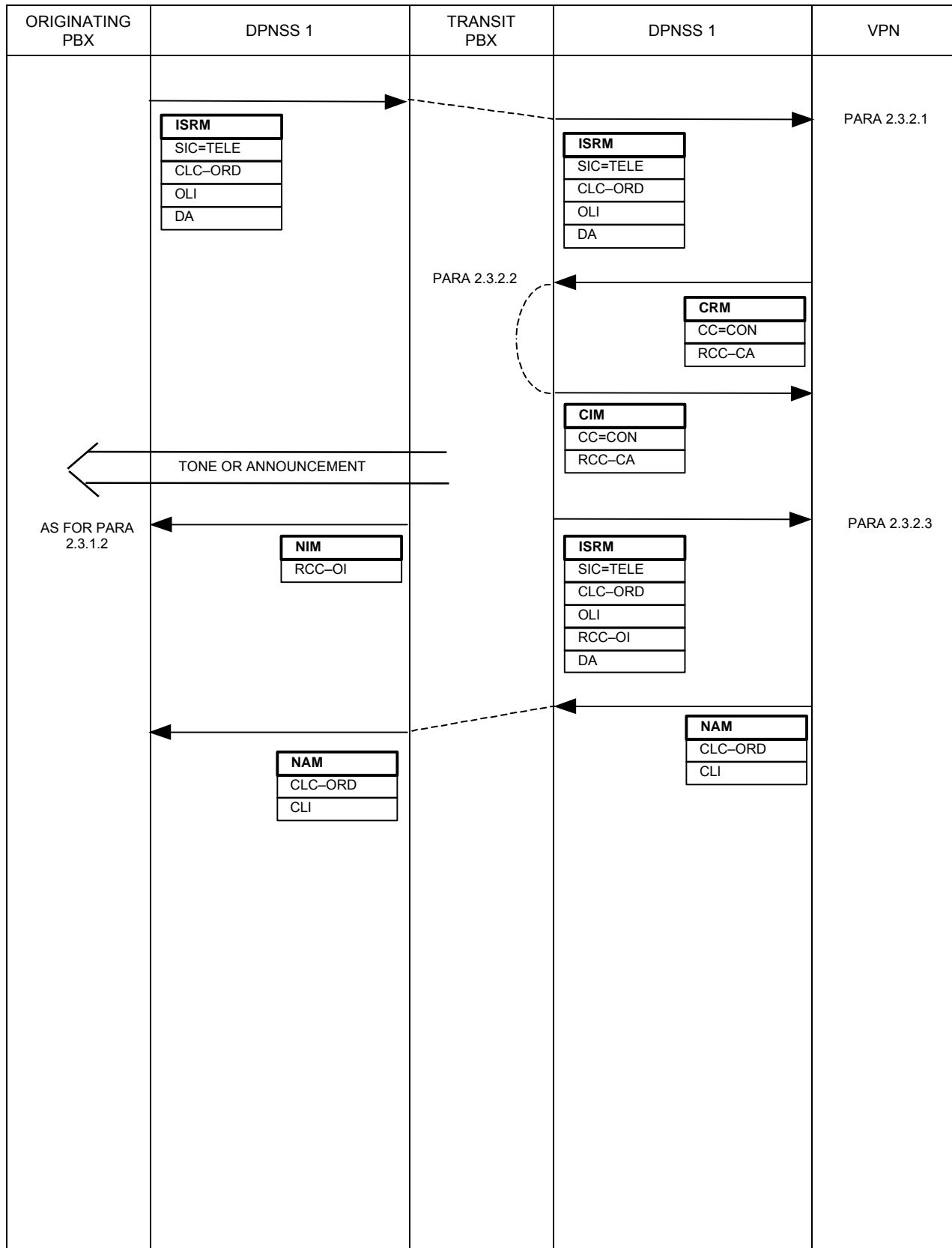

2.3.2.1 If, on encountering a congested route with additional capacity available, a VPN does not itself decide to invoke override on behalf of the calling user, it shall clear the call by sending a CRM containing Clearing Cause: CON and the String RCC-CA. A CIM shall be expected in response.

2.3.2.2 On receipt of the CRM containing RCC-CA, the preceding PBX may route the call forwards by invoking override or continue to clear the call backwards in the normal manner.

If the call is cleared backwards, then any preceding PBX may act upon the receipt of RCC-CA in the same manner. In this way, either call failure will be indicated to the caller or, one of the PBXs along the call path (which could be the Originating PBX) will invoke override.

If override is to be invoked by a Transit PBX, it shall either be invoked immediately or, after a delay during which the calling user shall be given an in-band indication that override is about to be invoked. If the calling user does not wish override to take place then the user may clear during the delay period resulting in the call being cleared forward.

The manner in which override is invoked by an Originating PBX is implementation dependent but may be influenced by the type of call set-up being attempted.

A PBX that invokes override shall route the call forwards in the normal manner but shall add RCC-OI to the ISRM. A Transit PBX that adds RCC-OI to an ISRM shall also return a NIM containing the string RCC-OI to indicate to the Originating PBX that override has been invoked.

2.3.2.3 On receipt of an ISRM containing RCC-OI where there is additional capacity available, the call shall be forwarded in the usual manner. The String RCC-OI shall be included in the outgoing ISRM. This may invoke override of subsequent congestion.

3 COMPLIANCE SHEETS FOR SUPPLEMENTARY SERVICE: ROUTE CAPACITY CONTROL

The Route Capacity Control Supplementary Service is an optional part of DPNSS 1 and its provision on a PBX or a VPN is a matter for negotiation between a customer and his supplier (see FOREWORD in SECTION 0 of this specification). This Subsection may be used as an aid to those negotiations.

NOTE: Whilst the provision of this service is optional, if it is provided, compliance with certain features of the service becomes mandatory.

Compliance with the service is considered in terms of the function(s) to be performed by a PBX or a VPN.

The options available are given in TABLE 1. This table should be completed by a manufacturer to indicate PBX capability and by a purchaser to indicate PBX requirements.

TABLES 2 to 5 indicate the features that are required/provided at each PBX or VPN. The pre-printed "YES" indicates that the feature is a mandatory part of the service for that function.

TABLE 1

PBX/VPN FUNCTION		APPLICABLE TABLE
VPN that supports the service		TABLE 2
Transit PBX that can request the service		TABLE 3
Originating PBX that can request the service		TABLES 4 and 5
PBX that cannot request the service		TABLE 5

TABLE 2

COMPLIANCE TABLE FOR A VPN THAT SUPPORTS ROUTE CAPACITY CONTROL		
SERVICE VARIANT		COMMENT
VPN able to invoke override without an indication from a PBX that override is required?		
VPN able to indicate to a PBX that override is available?		
VPN able to act upon an indication from a PBX that override is required?		Specify action taken

TABLE 3

COMPLIANCE TABLE FOR A TRANSIT PBX THAT CAN INVOKE ROUTE CAPACITY CONTROL		
SERVICE VARIANT		COMMENT
PBX able to invoke override on receipt of an indication that additional capacity is available?		
PBX able to invoke override without having received an indication that additional capacity is available?		

TABLE 4

COMPLIANCE TABLE FOR AN ORIGINATING PBX THAT CAN INVOKE ROUTE CAPACITY CONTROL		
SERVICE VARIANT		COMMENT
PBX able to invoke override on receipt of an indication that additional capacity is available?		
PBX able to invoke override without having received an indication that additional capacity is available?		

TABLE 5

COMPLIANCE TABLE FOR A PBX IN A NETWORK THAT SUPPORTS ROUTE CAPACITY CONTROL		
SERVICE VARIANT		COMMENT
PBX able to act on receipt of an indication that the service has been invoked?	YES	Specify action taken

DIGITAL PRIVATE NETWORK SIGNALLING SYSTEM NO 1 (DPNSS 1)

SECTION 45 - SUPPLEMENTARY SERVICE : WAIT ON BUSY

CONTENTS

1	GENERAL	Page 2
2	WAIT ON BUSY BETWEEN ORDINARY EXTENSIONS WITHIN DPNSS 1	Page 3
2.1	DEFINITION.....	Page 3
2.2	DESCRIPTION.....	Page 3
2.3	OUTLINE OF OPERATION.....	Page 3
2.3.1	Wait on Busy Requested by the Calling Party.....	Page 4
3	COMPLIANCE	Page 6

HISTORY

Issue 1 - January 1995

Issue 2 - March 2001 - Specification renamed as DPNSS[188]

1 GENERAL

1.1 This Section details the signalling requirements of DPNSS 1 for the Wait on Busy Supplementary Service.

1.2 Subsection 2 details the service within DPNSS 1.

1.3 Subsection 3 shows the Compliance.

1.4 The description is given in the form of Message Sequence Diagrams (MSDs) followed by explanatory text.

1.5 The text is referenced from MSDs at appropriate points in the sequences.

1.6 Message contents for successful calls are shown in MSDs. Messages and their contents for alternative sequences (eg for unsuccessful calls) are detailed in the text.

1.7 Coding of the contents of messages is given in SECTION 4.

2 WAIT ON BUSY BETWEEN ORDINARY EXTENSIONS WITHIN DPNSS 1

2.1 DEFINITION

The Wait On Busy service enables the calling party to retain a connection to the wanted party's PBX until the wanted party, who is busy (eg, on an already established call) becomes free so that the call can be connected automatically. No indication that a caller is waiting is given to the wanted party.

2.2 DESCRIPTION

A user encountering Busy may request Wait On Busy in an attempt to complete a Simple Call successfully.

On activation, a repeat call attempt is made by the requesting party's PBX on the basis of the original call data together with the Wait-On-Busy Request. If the new call encounters Busy the connection is retained across the network to the wanted party's PBX. When the wanted party becomes free, the wanted party will be re-rung and upon answer be connected to the requesting party.

An application for this service would be as a follow-on to an Enquiry Call (see SECTION 13) which had failed because the wanted party was busy. A repeat Enquiry Call containing a Wait-On-Busy Request would establish the new call to the wanted party's PBX; subsequent transfer of the held party would allow him to wait-on-busy for the enquired-to party to become free.

2.3 OUTLINE OF OPERATION

The Wait On Busy Supplementary Service is provided by the following signal sequence:

2.3.1 Wait On Busy Requested by the Calling Party

2.3.1 WAIT ON BUSY REQUESTED BY THE CALLING PARTY

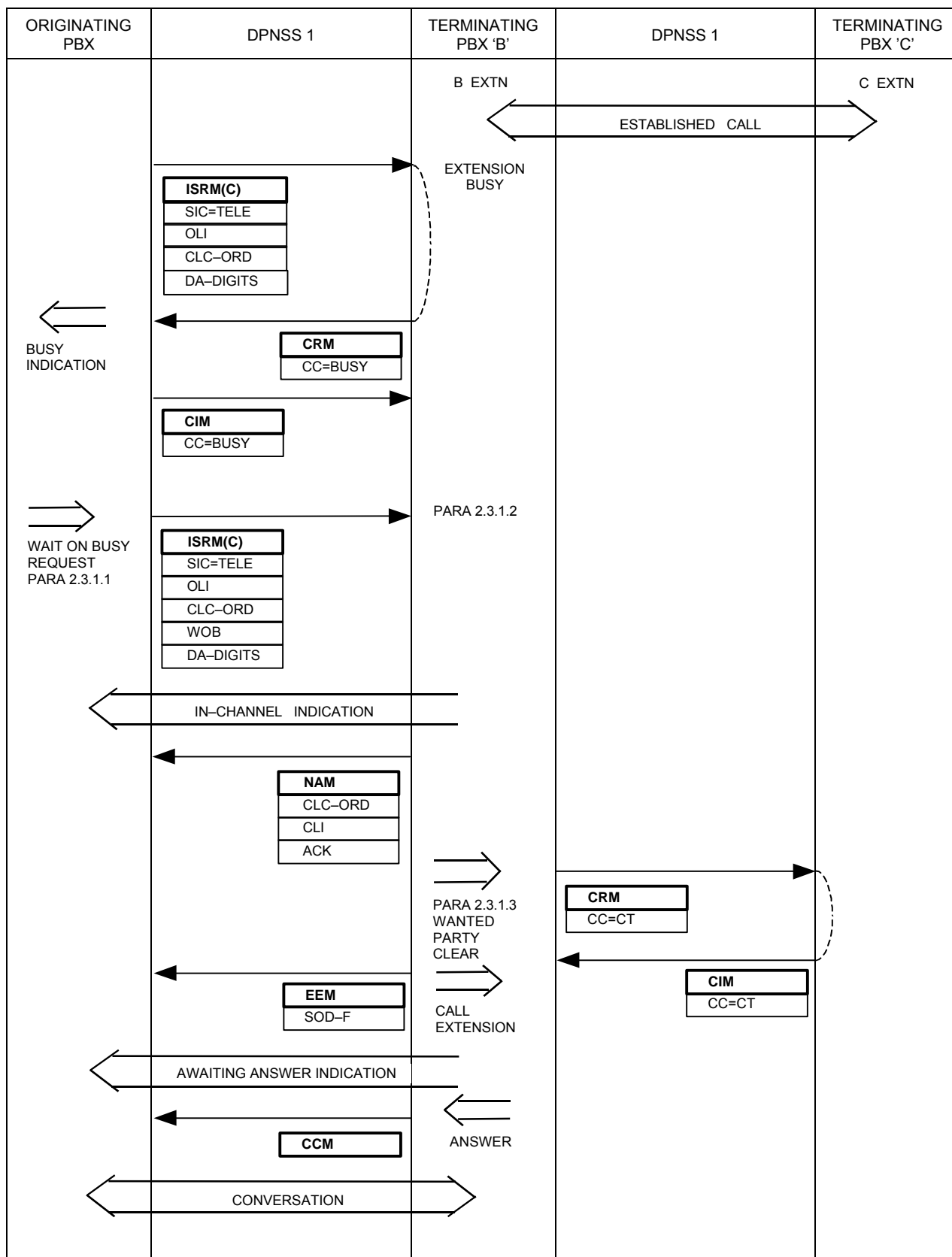

2.3.1.1 A Wait on Busy request will normally follow an unsuccessful call attempt. The period following an unsuccessful attempt during which Wait on Busy can be requested is dependent upon the design of the PBX.

Subject to the originating extension having the Wait on Busy capability, an ISRM shall be used to establish a connection to the wanted extension. The difference between this and a Simple Call ISRM is that it shall contain a "Wait on Busy" Request (WOB).

2.3.1.2 The request shall be validated against the Class of Service of the called extension and its call state.

If the called party has become free the call shall be completed as for a Simple Call.

If the Wait-On-Busy request is acceptable an in-channel indication shall be given to the requesting party and a NAM containing the Called Line Category, Called Line Identity, and Acknowledge shall be returned to the Originating PBX.

NOTE: No indication of the waiting call shall be given to the wanted party.

If the called extension would normally accept the call, if it were free, but Wait On Busy is not allowed, a CRM containing Clearing Cause: Busy shall be returned to the Originating PBX. A CIM shall be expected in response.

If the called extension is in a state where it cannot receive calls (eg Out of Service) the call shall be cleared with a CRM containing the appropriate Clearing Cause (see SECTION 4, ANNEX3)

2.3.1.3 The waiting call shall only be connected if the wanted party clears.

When the wanted party clears, a CRM shall be sent to the unwanted party's PBX, as for a Simple Call cleardown sequence, and an EEM containing SOD-F shall be sent to the Originating PBX. The wanted party shall be re-called, Awaiting Answer Indication shall be returned in the traffic channel and the waiting call shall be treated as a Simple Call awaiting answer.

2.3.1.4 If, after expiry of a timeout, the wanted party has not cleared, the Originating PBX may clear the call with a CRM containing Clearing Cause: NT. A CIM shall be expected in response, and busy tone may be returned to the requesting party.

If the caller clears without the call being completed, a CRM containing Clearing Cause: Call Termination (CT) shall be sent to the wanted party's PBX. A CIM shall be expected in response.

3 COMPLIANCE SHEETS FOR SUPPLEMENTARY SERVICE: WAIT ON BUSY

The Wait On Busy Supplementary Service is an optional part of DPNSS 1 and its provision on a PBX is a matter for negotiation between a customer and his supplier (see FOREWORD in SECTION 0 of this specification). This Subsection may be used as an aid to those negotiations.

NOTE: Whilst the provision of this service is optional, if it is provided, compliance with certain features of the service becomes mandatory.

Compliance with the service is considered in terms of the function(s) to be performed by the PBX ie Transit, End or Branching and the extent to which operators or extensions on the PBX can request the service.

The options available are given in TABLE 1. This table should be completed by a manufacturer to indicate PBX capability and by a purchaser to indicate PBX requirements.

TABLES 2 to 4 indicate the features that are required/provided at each PBX. The preprinted "YES" indicates that the feature is a mandatory part of the service for that PBX function.

TABLE 1

PBX FUNCTION		APPLICABLE TABLE
PBX with operators or extensions, some of which can request the service.		TABLES 2 & 3
PBX with operators or extensions, none of which can request the service.		TABLE 2
Transit PBX		TABLE 4

TABLE 2

COMPLIANCE TABLE FOR A PBX WITH OPERATORS OR EXTENSIONS IN A NETWORK THAT SUPPORTS WAIT ON BUSY		
SERVICE VARIANT		COMMENT
Able to accept a Wait On Busy Request?	YES	
Able to accept a Wait On Busy Call when the existing call clears?	YES	

TABLE 3

ADDITIONAL COMPLIANCE TABLE FOR A PBX WITH OPERATORS OR EXTENSIONS THAT ARE ABLE TO REQUEST WAIT ON BUSY		
SERVICE VARIANT		COMMENT
Able to request that a call be held in a Wait On Busy State for an extension on another DPNSS 1 PBX?	YES	
Able to take further action should the Wait On Busy be ignored by the wanted party for a length of time?		Specify action taken

TABLE 4

COMPLIANCE TABLE FOR A TRANSIT PBX IN A NETWORK THAT SUPPORTS WAIT ON BUSY		
SERVICE VARIANT		COMMENT
Able to transit Wait On Busy Requests?	YES	Inherent DPNSS 1 capability

DIGITAL PRIVATE NETWORK SIGNALLING SYSTEM NO 1 (DPNSS 1)

SECTION 46 - SUPPLEMENTARY SERVICE: CALL PICK-UP

CONTENTS

1	GENERAL	Page 2
2	CALL PICK-UP BETWEEN ORDINARY EXTENSIONS WITHIN DPNSS 1	Page 3
2.1	DEFINITION	Page 3
2.2	DESCRIPTION	Page 3
2.2.1	Group Pick-Up	Page 3
2.2.2	Directed Pick-Up	Page 3
2.2.3	Night Bell Pick-Up	Page 4
2.3	OUTLINE OF OPERATION	Page 5
2.3.1	Group Pick-Up	Page 6
2.3.2	Directed Pick-Up	Page 10
2.3.3	Call Pick-Up on the Same PBX	Page 12
3	COMPLIANCE	Page 13

HISTORY

Issue 1 - January 1995

Issue 2 - March 2001 - Specification renamed as DPNSS[188]
- Clearing during DVG-R Call Set Up added

1 GENERAL

- 1.1** This Section details the signalling requirements of DPNSS 1 for the Call Pick-Up Supplementary Service.
- 1.2** Subsection 2 details the service within DPNSS 1.
- 1.3** Subsection 3 shows the Compliance.
- 1.4** The description is given in the form of Message Sequence Diagrams (MSDs) followed by explanatory text.
- 1.5** The text is referenced from MSDs at appropriate points in the sequences.
- 1.6** Message contents for successful calls are shown in MSDs. Messages and their contents for alternative sequences (eg for unsuccessful calls) are detailed in the text.
- 1.7** Coding of the contents of messages is given in SECTION 4.

2 CALL PICK-UP BETWEEN ORDINARY EXTENSIONS WITHIN DPNSS 1

2.1 DEFINITION

Call Pick-Up enables extension users to answer a call that is awaiting answer or reconnection at another extension [Target Extension]. Two separate types of Call Pick-up are defined: Group Pick-Up where the Target Extension is one of a predefined group, and Directed Pick-Up where the extension is specifically identified. Directed Pick-Up allows an extension to answer a call that is ringing, held, parked or waiting at another extension, whereas Group Pick-Up allows only ringing or waiting calls to be picked up.

A specific use of Call Pick-Up to enable extensions to answer calls that have been directed to a Night Bell is also described.

The ability to pick-up calls that are ringing is mandatory in both Group Pick-up and Directed Pick-up. Pick-Up of parked, held or waiting calls is optional.

2.2 DESCRIPTION

When a user requests either Group Pick-Up or Directed Pick-Up, the requester's PBX [PBX-R] sends a Pick-Up Request to the Target Extension's PBX [PBX-T]. In the case of Group Pick-Up there may be more than one PBX-T.

On receipt of the Pick-Up Request, PBX-T instructs the other PBX in the call, the Originating PBX, [PBX-O] to divert the call to the requesting extension.

Certain extensions may have the capability to prevent their calls from being picked up.

2.2.1 Group Pick-Up

Group Pick-Up enables an extension to answer incoming calls that are awaiting answer at extensions on other PBXs when the extensions are in a Pick-Up Group. Where more than one call is available for pick-up at the same PBX, that PBX shall select which call is picked up. Priority may be given to certain types of call, eg those which involve the PSTN.

2.2.2 Directed Pick-Up

Directed Pick-Up enables an extension user to identify explicitly the extension required for Pick-Up. The user may request Pick-Up of a ringing, held, parked or waiting call.

2.2.3 Night Bell Pick-Up

Night Bell Pick-Up utilises the Call Pick-Up signalling to enable extension users to pick-up calls that have been redirected to a Night Bell.

On a PBX provided with this facility, any extension may request Night Bell Pick-Up and the PBX will automatically treat the request, either as a Directed Pick-Up Request to the address associated with a Night Bell, or as a Group Pick-Up Request for a group containing addresses associated with a number of Night Bells.

2.3 OUTLINE OF OPERATION

The Call Pick-Up Supplementary Service is specified by the following Signalling sequences:

- 2.3.1 Group Pick-Up
- 2.3.2 Directed Pick-Up
- 2.3.3 Call Pick-Up on the Same PBX

The operation of the Call Pick-Up Service using Single Channel Working is not described in this issue.

2.3.1 GROUP PICK-UP

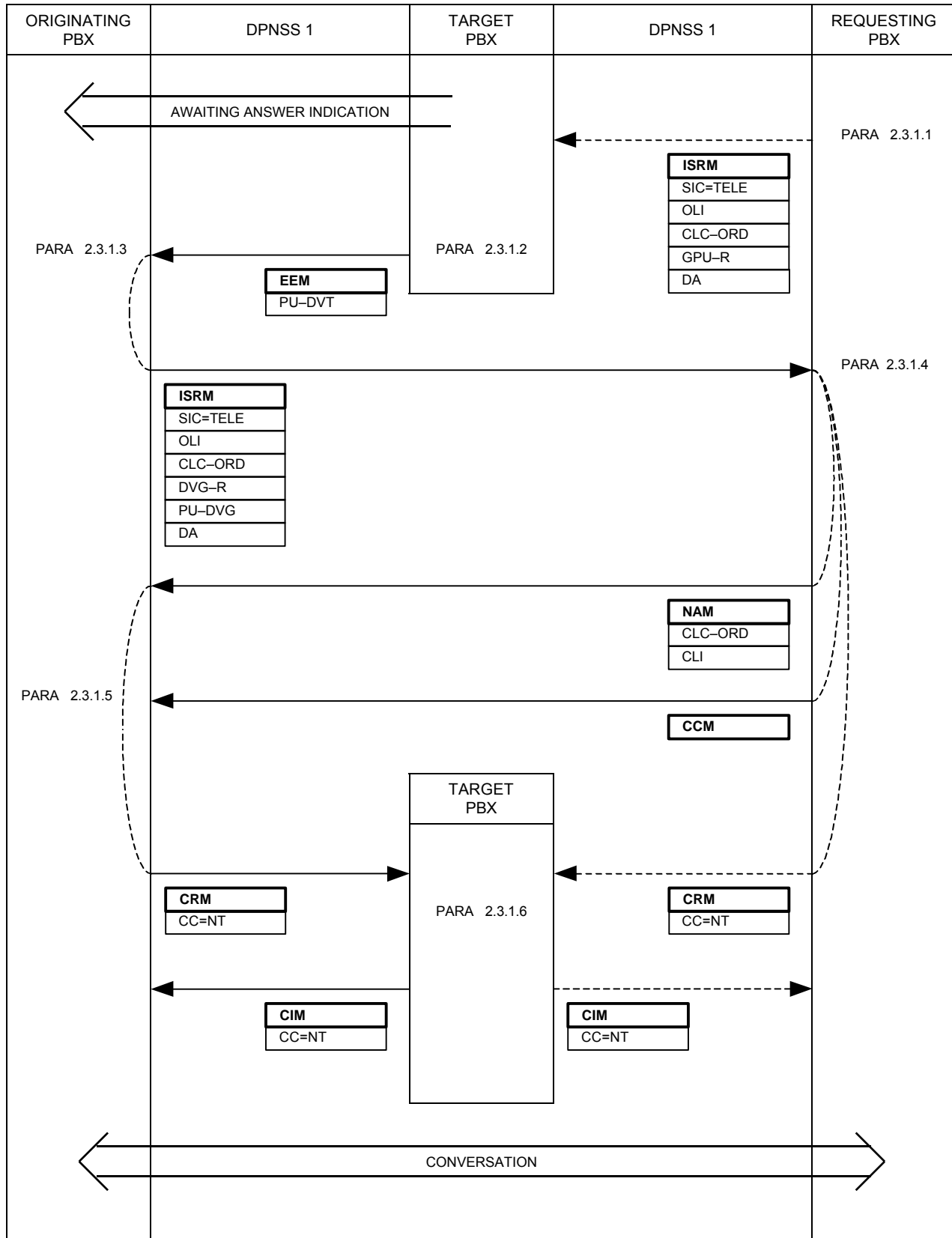

2.3.1.1 When an extension requests Group Pick-Up, PBX-R (the Requesting PBX) shall make a Virtual Call to each of the other PBXs that have extensions belonging to the Pick-Up Group identified by the request.

The ISRM sent on each Virtual Call shall contain SIC=TELE, Strings CLC-ORD, OLI and GPU-R (Group Pick-Up Request) and the DA. Each DA shall be a sequence of digits that will route the call to the required PBX and identify the process that deals with the Group Pick-Up request.

2.3.1.2 On receipt of an ISRM containing GPU-R, each PBX-T (Target PBX) shall select an extension, from the Pick-Up Group indicated in the Parameter of the GPU-R String, that is involved in a call which can be picked up. The criteria for selecting which call is to be picked up is PBX dependent, for example, a PBX-T may be configured to give priority to extensions that are awaiting answer on calls that involve the PSTN.

If a suitable call is found, PBX-T shall send to PBX-O (the Originating PBX) an EEM containing PU-DVT (Pick-Up Divert). The C-PARTY ADDRESS Parameter of PU-DVT shall be the OLI that was received in the Virtual Call ISRM containing the Group Pick-Up request.

Optionally a second Parameter to PU-DVT, TIME INTERVAL, may be included to indicate the length of time the selected call has been awaiting answer.

If no suitable call is found, the Virtual Call shall be cleared by sending a CRM containing Clearing Cause: STU to PBX-R. A CIM shall be expected in response.

2.3.1.3 On receipt of an EEM containing PU-DVT, PBX-O shall send to PBX-R an ISRM containing SIC=TELE, Strings CLC, OLI, DVG-R, PU-DVG (Pick-Up Diverting) and the DA. The DA shall be the C-PARTY ADDRESS Parameter to the PU-DVT String that was received in the EEM. The Parameter of DVG-R shall be the address of the extension from which the call has been picked up.

If PU-DVT received in the EEM from PBX-T contained the TIME INTERVAL Parameter then, depending on the design of PBX-O, the value of this Parameter may be transferred to the optional TIME INTERVAL Parameter of PU-DVG sent in the ISRM to PBX-R.

2.3.1.4 At this point in the sequence, PBX-R shall be awaiting a response from each of the Virtual Call requests (see paragraph 2.3.1.1). Each call will result in, either a CRM on the Virtual Channel rejecting the request, or an ISRM containing PU-DVG on a new call from PBX-O. These may occur in any order.

The criteria used by PBX-R for selecting which call shall be picked-up is PBX dependent. For example: PBX-R may select the first incoming call containing DVG-R and PU-DVG that is addressed to the requesting party or, alternatively, PBX-R may await the arrival of some or all appropriate pick-up diverting calls and select a call on the basis of CLC and/or waiting time as indicated in the PU-DVG TIME INTERVAL Parameter, if present.

PBX-R shall connect the selected call to the requesting extension and return to PBX-O a NAM containing CLC and CLI, followed immediately by a CCM. PBX-R shall then release all of the remaining Virtual Calls by sending a CRM containing Clearing Cause: NT on each. A CIM shall be expected in response to each CRM.

The selected call shall continue as a Simple Call.

Picked-up calls not selected for connection to the requesting party shall be cleared by sending to each PBX-O a CRM containing Clearing Cause: NT. A CIM shall be expected in response to each CRM.

If the DA in the ISRM does not identify a party on whom Call Pick-Up is still active, the new call shall be cleared by sending a CRM containing Clearing Cause: FNR (Facility Not Registered). This may for example occur where an ISRM from a different PBX-O has already been accepted. A CIM shall be expected in response.

If a CRM is received on any of the Virtual Calls, PBX-R shall respond to each with a CIM.

If all of the Virtual Calls are cleared before receipt of an ISRM then a suitable failure indication shall be given to the requesting extension.

If, before the receipt of an ISRM containing PU-DVG, the requesting user terminates the Pick-Up Request, a CRM containing Clearing Cause: CT shall be sent on each remaining Virtual Call. A CIM shall be expected in response to each CRM.

2.3.1.5 On receipt of a NAM, PBX-O shall switch the originating party to the new call and clear the original call by sending a CRM containing Clearing Cause: NT. A CIM shall be expected in response.

If a CCM is received on the original call before the NAM is received on the new call, then PBX-O shall clear the new call by sending a CRM containing Clearing Cause: NT to PBX-R. A CIM shall be expected in response.

If a CRM is received on the new call instead of the NAM then PBX-O shall send an EEM containing REJ to PBX-T on the old call.

If the original call is cleared before a NAM on the new call has been received, either by receipt of a CRM on the original call or by the originating party clearing, PBX-O shall clear the new call by sending a CRM containing Clearing Cause: CT to PBX-R. A CIM shall be expected in response.

2.3.1.6 At this point in the sequence, PBX-T shall be awaiting the outcome of the EEM containing PU-DVT that was sent (see paragraph 2.3.1.2). This will result in one of the following:

- rejection of the EEM;
- release of the Virtual Call because the requesting party has either picked up another call or has cleared, or
- release of both the Virtual Call and the original call because the requesting party has completed the pick-up of the original call to the target party (the release of the two calls may occur in any order).

If a CRM is received on the Virtual Channel from PBX-R, PBX-T shall remove all references to the Pick-Up request and the original call shall remain unaffected. A CIM shall be returned in response.

If a CRM is received on the Original call from PBX-O before receipt of a CRM on the Virtual Channel from PBX-R, then PBX-T shall return a CIM to PBX-O in response. PBX-T shall release the Virtual Call from PBX-R by sending a CRM containing Clearing Cause: NT. A CIM shall be expected in response.

If PBX-T receives an EEM containing REJ or SNU from PBX-O (indicating failure to establish a call from the originating party to the requesting party) then PBX-T shall clear the Virtual Call from PBX-R by sending a CRM containing Clearing Cause: REJ. A CIM shall be expected in response. PBX-T shall remove all references to the Pick-Up request and the original call shall remain unaffected.

2.3.2 DIRECTED PICK-UP

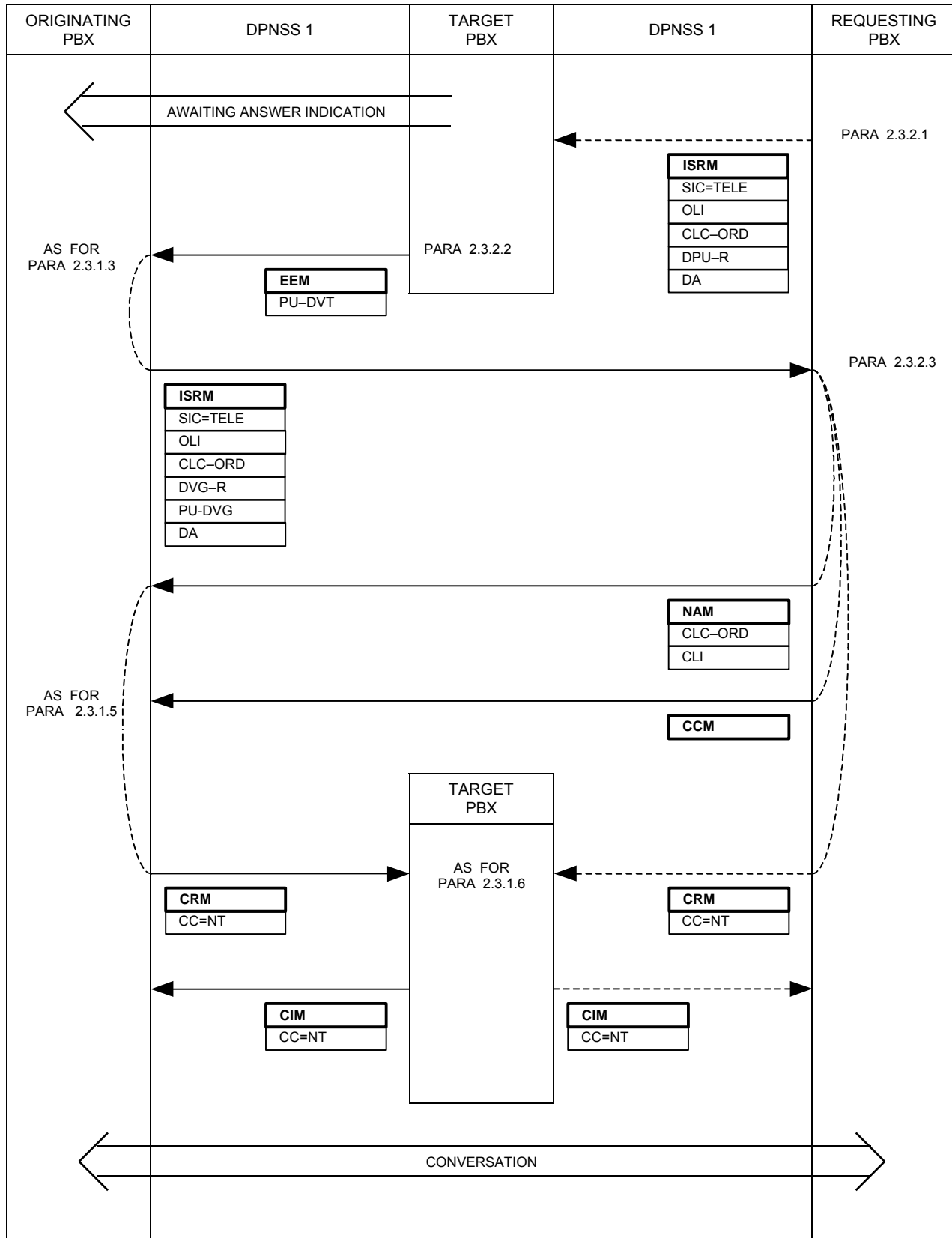

2.3.2.1 When an extension requests Directed Pick-Up, PBX-R (the Requesting PBX) shall make a Virtual Call to PBX-T (the Target PBX). The ISRM shall contain SIC=TELE, Strings CLC-ORD, CLI and DPU-R and the DA. The DA shall be that of the Target extension. The Parameter of DPU-R shall identify the type of Pick-Up required, ie ringing, on hold, parked or waiting, or a combination of these. If the DPU-R String has no Parameter then PBX-T shall decide which type of Call Pick-Up is selected.

2.3.2.2 On receipt of an ISRM containing DPU-R, PBX-T shall determine whether Pick-Up is allowed and, if so, shall send an EEM containing PU-DVT on the existing call. The decision as to whether a call can be picked up is determined by the Parameter of the DPU-R String (if present) and the type(s) of Pick-Up supported by PBX-T.

If Pick-Up is not allowed, then a CRM containing Clearing Cause: STU shall be returned to PBX-R. A CIM shall be expected in response.

2.3.2.3 On receipt of an ISRM containing DVG-R and PU-DVG, PBX-R shall connect the call to the requesting extension and shall return a NAM to PBX-O (the Originating PBX), followed immediately by a CCM. PBX-R shall then clear the Virtual Call by sending a CRM containing Clearing Cause: NT. A CIM shall be expected in response.

If the DA in the ISRM does not identify a call on which call Pick-Up is active, the new call shall be cleared by sending a CRM containing Clearing Cause: FNR. This may occur, for example, if Party-R has cleared. A CIM shall be expected in response.

If a CRM is received on the Virtual Call before receipt of an ISRM containing PU-DVG, PBX-R shall respond with a CIM and should apply a suitable failure indication to the requesting extension.

If, before the receipt of an ISRM containing PU-DVG, the requesting party terminates the Pick-Up Request, a CRM containing Clearing Cause: CT shall be sent to release the Virtual Call. A CIM shall be expected in response.

2.3.3 CALL PICK-UP ON THE SAME PBX

If the requesting extension is on the same PBX as the target extension then, except in the case of a Held call, the Pick-Up shall be completed and a CCM containing CLC, CLI and PU-DVD shall be sent to the Originating PBX. In the case of a Held call, the Call Pick-Up shall be completed by sending to the Originating PBX an EEM containing RECON, PU-DVD and the CLC and CLI of the requesting extension.

3 COMPLIANCE SHEETS FOR THE SUPPLEMENTARY SERVICE: CALL PICK-UP

The Call Pick-Up Service is split into two types and each is an optional part of DPNSS 1, and their provision on a PBX is a matter for negotiation between a customer and his supplier (see FORWARD in SECTION 0 of this specification). This Subsection may be used as an aid to those negotiations.

NOTE: Whilst the provision of each type of Call Pick-Up is optional, if a type is provided, compliance with certain features of that type becomes mandatory.

Compliance with the service is considered in terms of the function(s) to be performed by the PBX, ie Transit, End or Branching, and the extent to which operators or extensions on the PBX can request the service.

The Call Pick-Up Service is split into two types:

- Group Pick-Up,
- Directed Pick-Up.

The Compliance Tables are allocated a separate Subsection for each type of Call Pick-Up.

TABLE 0 should be completed by a manufacturer to indicate PBX capability and by a purchaser to indicate PBX requirements.

TABLE 0

SERVICE		APPLICABLE SUBSECTION OF COMPLIANCE SHEETS
Group Pick-Up		3.1
Directed Pick-Up		3.2

3.1 COMPLIANCE SHEETS FOR THE GROUP PICK-UP SERVICE

The options available are given in TABLE 1. This table should be completed by a manufacturer to indicate PBX capability and by a purchaser to indicate PBX requirements.

TABLES 2 to 4 indicate the features which are required/provided at each PBX. The pre-printed "YES" indicates that the feature is a mandatory part of the service for that PBX function.

It should be noted that the Group Pick-Up Service requires co-operation between the PBXs involved in a call and unless all of the PBXs in a private network support the service, the extension users will experience inconsistent results.

TABLE 1

PBX FUNCTION		APPLICABLE TABLE
PBX with operators or extensions, some of which can request the service.		TABLES 2 & 3
PBX with operators or extensions, none of which can request the service.		TABLE 2
Transit PBX.		TABLE 4

TABLE 2

COMPLIANCE TABLE FOR A PBX WITH OPERATORS OR EXTENSIONS IN A NETWORK THAT SUPPORTS THE GROUP PICK-UP SERVICE		
SERVICE VARIANT		COMMENT
Able to accept a Group Pick-Up Request for a ringing call from another DPNSS 1 PBX and instruct the Originating PBX to divert the call?	YES	
Able to accept a Group Pick-Up Request for a waiting call from another DPNSS 1 PBX and instruct the Originating PBX to divert the call?		
Able to accept a Group Pick-Up Divert Instruction for a call from a Target PBX and to establish a diverting call to a Requesting PBX?	YES	

TABLE 3

ADDITIONAL COMPLIANCE TABLE FOR A PBX WITH EXTENSIONS THAT ARE CAPABLE OF REQUESTING GROUP PICK-UP		
SERVICE VARIANT		COMMENT
Able to process a Group Pick-Up Request from an extension for a ringing call on another DPNSS 1 PBX?	YES	
Able to process a Group Pick-Up Request from an extension for a waiting call on another DPNSS 1 PBX?		
Able to inform another DPNSS 1 PBX that an incoming call has been picked-up by an extension within the PBX.		

TABLE 4

COMPLIANCE TABLE FOR A TRANSIT PBX IN A NETWORK THAT SUPPORTS THE GROUP PICK-UP SERVICE		
SERVICE VARIANT		COMMENT
Able to act as a Transit PBX for Group Pick-Up Calls received on a separate channel to the original call?	YES	Inherent DPNSS 1 capability

3.2 COMPLIANCE SHEETS FOR THE DIRECTED PICK-UP SERVICE

The options available are given in TABLE 1. This table should be completed by a manufacturer to indicate PBX capability and by a purchaser to indicate PBX requirements.

TABLES 2 to 4 indicate the features which are required/provided at each PBX. The pre-printed "YES" indicates that the feature is a mandatory part of the service for that PBX function.

It should be noted that the Directed Pick-Up Service requires co-operation between the PBXs involved in a call and unless all of the PBXs in a private network support the service, the extension users will experience inconsistent results.

TABLE 1

PBX FUNCTION		APPLICABLE TABLE
PBX with operators or extensions, some of which can request the service.		TABLES 2 & 3
PBX with operators or extensions, none of which can request the service.		TABLE 2
Transit PBX.		TABLE 4

TABLE 2

COMPLIANCE TABLE FOR A PBX WITH OPERATORS OR EXTENSIONS IN A NETWORK THAT SUPPORTS THE DIRECTED PICK-UP SERVICE		
SERVICE VARIANT		COMMENT
Able to accept a Directed Pick-Up Request for a ringing call from another DPNSS 1 PBX and instruct the Originating PBX to divert the call?	YES	
Able to accept a Directed Pick-Up Request for a waiting call from another DPNSS 1 PBX and instruct the Originating PBX to divert the call?		
Able to accept a Directed Pick-Up Request for a held call from another DPNSS 1 PBX and instruct the Originating PBX to divert the call?		
Able to accept a Directed Pick-Up Request for a parked call from another DPNSS 1 PBX and instruct the Originating PBX to divert the call?		
Able to accept a Call Pick-Up Divert Instruction for a call from a Target PBX and to establish a diverting call to a Requesting PBX?	YES	

TABLE 3

ADDITIONAL COMPLIANCE TABLE FOR A PBX WITH EXTENSIONS THAT ARE CAPABLE OF REQUESTING DIRECTED PICK-UP		
SERVICE VARIANT		COMMENT
Able to process a Directed Pick-Up Request from an extension for a ringing call on another DPNSS 1 PBX?	YES	
Able to process a Directed Pick-Up Request from an extension for a waiting call on another DPNSS 1 PBX?		
Able to process a Directed Pick-Up Request from an extension for a held call on another DPNSS 1 PBX?		
Able to process a Directed Pick-Up Request from an extension for a parked call on another DPNSS 1 PBX?		
Able to inform another DPNSS 1 PBX that an incoming call has been picked-up by an extension within the PBX.		

TABLE 4

COMPLIANCE TABLE FOR A TRANSIT PBX IN A NETWORK THAT SUPPORTS THE DIRECTED PICK-UP SERVICE		
SERVICE VARIANT		COMMENT
Able to act as a Transit PBX for Directed Pick-Up Calls received on a separate channel to the original call?	YES	Inherent DPNSS 1 capability

DIGITAL PRIVATE NETWORK SIGNALLING SYSTEM NO 1 (DPNSS 1)

SECTION 47 - SUPPLEMENTARY SERVICE: TRAVELLING CLASS OF SERVICE

CONTENTS

1	GENERAL	Page 2
2	TRAVELLING CLASS OF SERVICE WITHIN DPNSS 1	Page 3
	2.1 DEFINITION.....	Page 3
	2.2 DESCRIPTION.....	Page 3
	2.3 OUTLINE OF OPERATION.....	Page 3
	2.3.1 Travelling Class of Service.....	Page 4
3	COMPLIANCE	Page 6

HISTORY

Issue 1 - January 1995

Issue 2 - March 2001 - Specification renamed as DPNSS[188]

1 GENERAL

1.1 This Section details the signalling requirements of DPNSS 1 for the Supplementary Service: Travelling Class of Service.

1.2 Subsection 2 details the service within DPNSS 1.

1.3 Subsection 3 shows the Compliance.

1.4 The description is given in the form of Message Sequence Diagrams (MSDs) followed by explanatory text.

1.5 The text is referenced from MSDs at appropriate points in the sequences.

1.6 Message contents for successful calls are shown in MSDs. Messages and their contents for alternative sequences (eg for unsuccessful calls) are detailed in the text.

1.7 Coding of the contents of messages is given in SECTION 4.

2 TRAVELLING CLASS OF SERVICE WITHIN DPNSS 1

2.1 DEFINITION

Travelling Class Of Service enables users of extensions remote from their home extensions to request that the Travelling Class Of Service Parameters of their home extensions be applied to the requesting extensions for the duration of a subsequent call or other service request.

Requests for the service may optionally require the use of a password.

2.2 DESCRIPTION

This Supplementary Service requires that the home extension number of the requesting party be entered when requesting the service. As a PBX option, a password may also be required.

If the request is successful, the PBX on which the requesting extension is parented shall have access to the Travelling Class of Service of the home extension for use during the subsequent call attempt or other service request. Following return of the requesting extension to the on-hook condition, the Class of Service of the requesting extension shall revert to the normal local value.

It shall be an implementation option at the requesting PBX whether a Password shall be required.

If the Password option is implemented it is recommended that the password shall consist of a sequence of 6 decimal numbers (0 to 9).

Attention is drawn to the security aspects of this service. Only privileged extensions should be allowed to make unrestricted use of this service. In order to allow a party to request the service from any extension and still provide a secure service, provision should be made for the entry of a password to be required as part of the request procedure. The entered password would be forwarded for checking against the password registered at the home extension.

NOTE: A network which does not employ the password option can be regarded as a network where all extensions are privileged extensions.

2.3 OUTLINE OF OPERATION

The Travelling Class Of Service Supplementary Service shall be implemented using the signalling sequences described in Paragraph 2.3.1.

2.3.1 TRAVELLING CLASS OF SERVICE

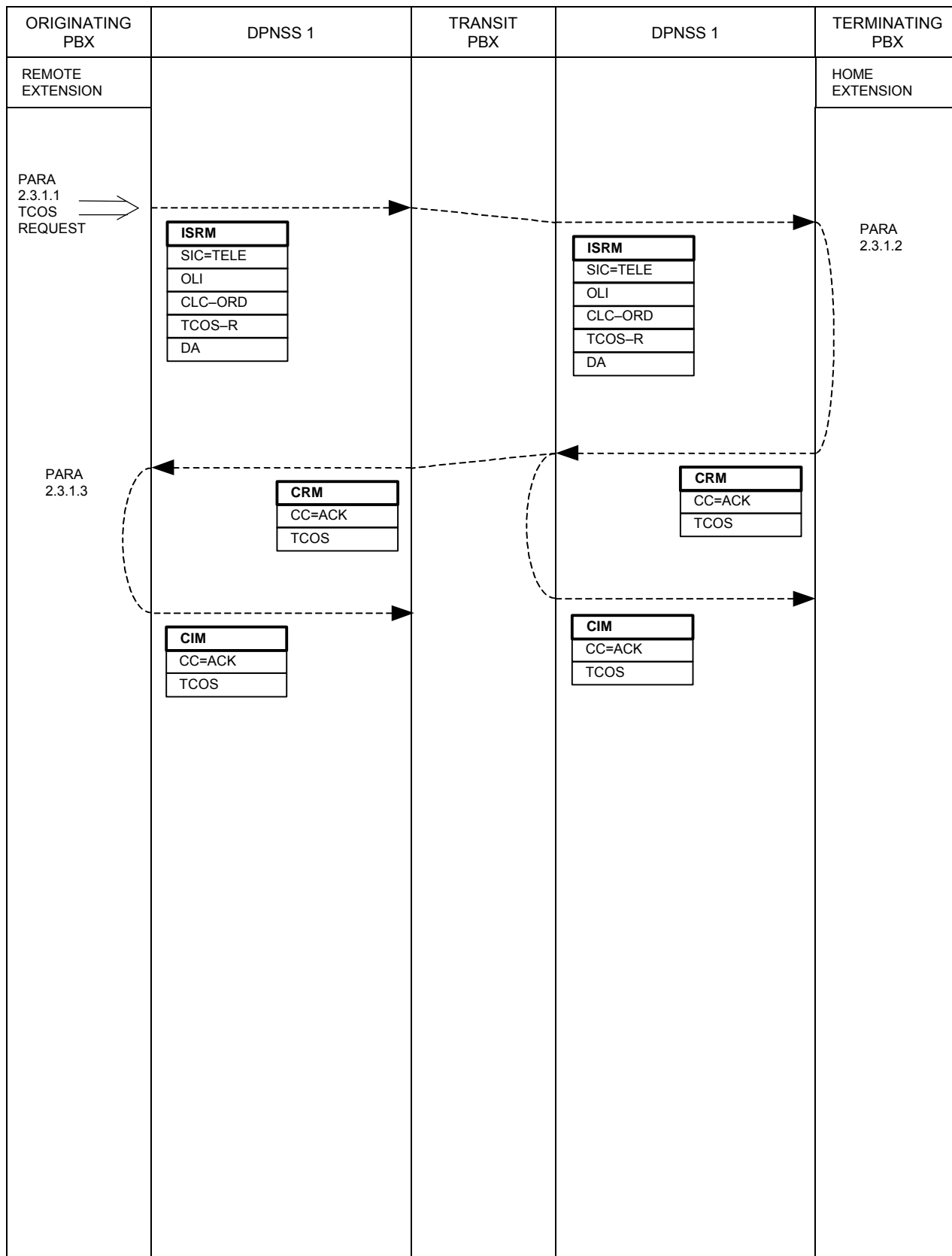

2.3.1.1 A request for the Travelling Class Of Service (TCOS) of a party's home extension made from a remote extension shall be validated by the Originating (remote) PBX. The validation shall include ensuring that a password is entered in the case where a non-privileged extension is used to request the service. Failure to enter a password when one is required will result in the request being rejected by the Originating PBX.

When a request is made from a privileged extension a password shall not be required, however, if one is entered it is recommended that it be accepted and included as the Password Parameter to TCOS-R.

If the request is valid, a Virtual Call shall be established to the requesting party's home PBX using a DA derived from the home extension number entered by the requesting party. The ISRM shall include the Strings OLI, CLC and TCOS-R. TCOS-R shall include the Password Parameter if one was entered.

2.3.1.2 On receipt of the ISRM containing TCOS-R at the Terminating PBX, a check shall be made whether TCOS is configured against the home extension (DA).

If TCOS is not configured against the DA, then the Terminating PBX shall respond by sending a CRM containing Clearing Cause: SU. A CIM shall be expected in response.

If TCOS is configured against the DA, then the action to be taken by the Terminating PBX depends on whether a Password Parameter was included with TCOS-R:

- If no Password Parameter was received with TCOS-R then it shall be assumed that the remote extension was privileged and the request shall be treated as valid.
- If the Password Parameter was present with TCOS-R then the action to be taken also depends on whether a password is set against the home extension (DA):
 - i. If there is no password set against the home extension then the request shall be treated as valid.
 - ii. If there is a password set against the home extension and the received password matches it then the request shall be treated as valid.

If the received password does not match that set against the home extension the request shall be treated as invalid.

If the request is valid then the Terminating PBX shall respond with a CRM containing Clearing Cause: ACK and the String TCOS. The TCOS String shall contain the Travelling Class of Service Parameters of home extension. A CIM shall be expected in response.

If the request is invalid then the Terminating PBX shall respond with a CRM containing Clearing Cause: REJ. A CIM shall be expected in response.

2.3.1.3 On receipt of the CRM containing Clearing Cause: ACK and the String TCOS at the Originating PBX the TCOS Parameters shall be stored. A CIM shall be returned in response.

The requesting party should be given a confirmation indication (eg proceed indication) so that he can, for example, make a follow-on call, invoke, register or interrogate a Supplementary Service, or perform any other action that his TCOS will permit him at the remote extension. Once the requesting extension is returned to the on-hook condition its Class Of Service shall revert to the normal local value.

Receipt of a CRM containing any Clearing Cause other than ACK, or not containing the TCOS String, indicates that the Travelling Class of Service Request has failed. A CIM shall be returned in response. An appropriate failure indication should be given to the requesting extension.

3 COMPLIANCE SHEETS FOR THE SUPPLEMENTARY SERVICE: TRAVELLING CLASS OF SERVICE

The Travelling Class of Service Supplementary Service is an optional part of DPNSS 1 and its provision on a PBX is a matter for negotiation between a customer and his supplier (see FOREWORD in SECTION 0 of this specification). This Subsection may be used as an aid to those negotiations.

NOTE: Whilst the provision of this service is optional, if it is provided, compliance with certain features of the service becomes mandatory.

Compliance with the service is considered in terms of the function(s) to be performed by the PBX, ie Transit, End or Branching, and the extent to which operators or extensions on the PBX can request the service.

The options available are given in TABLE 1. This table should be completed by a manufacturer to indicate PBX capability and by a purchaser to indicate PBX requirements.

TABLES 2 to 4 indicate the features that are required/provided at each PBX. The pre-printed "YES" indicates that the feature is a mandatory part of the service for that PBX function.

TABLE 1

PBX FUNCTION		APPLICABLE TABLE
PBX with an operator or extensions, some of which can request the service		TABLES 2 and 3
PBX with an operator or extensions, none of which can request the service		TABLE 2
Transit PBX		TABLE 4

TABLE 2

COMPLIANCE TABLE FOR A PBX WITH OPERATORS OR EXTENSIONS IN A NETWORK THAT SUPPORTS TRAVELLING CLASS OF SERVICE		
SERVICE VARIANT		COMMENT
Able to respond correctly to Travelling Class Of Service-Request?	YES	

TABLE 3

ADDITIONAL COMPLIANCE TABLE FOR A PBX WITH OPERATORS OR EXTENSIONS THAT ARE ABLE TO ORIGINATE A TRAVELLING CLASS OF SERVICE-REQUEST		
SERVICE VARIANT		COMMENT
Able to originate a Travelling Class Of Service-Request?	YES	
Able to originate the request from a privileged extension?		
Able to originate the request from a non-privileged extension?		

TABLE 4

COMPLIANCE TABLE FOR A TRANSIT PBX IN A NETWORK THAT SUPPORTS TRAVELLING CLASS OF SERVICE-REQUEST		
SERVICE VARIANT		COMMENT
Able to transit a Travelling Class Of Service-Request with and without associated passwords (Virtual Call)?	YES	Inherent DPNSS 1 capability

DIGITAL PRIVATE NETWORK SIGNALLING SYSTEM NO 1 (DPNSS 1)

**SECTION 48 - SUPPLEMENTARY SERVICE: NUMBER PRESENTATION
RESTRICTION**

CONTENTS

1	GENERAL	Page 2
2	NUMBER PRESENTATION RESTRICTION WITHIN DPNSS 1	Page 3
	2.1 DEFINITION.....	Page 3
	2.2 DESCRIPTION.....	Page 3
	2.3 OUTLINE OF OPERATION.....	Page 5
	2.3.1 Simple Call.....	Page 6
	2.3.2 Transfer.....	Page 7
	2.3.3 On-PBX Diversion: Immediate or On-Busy...Page 8	
	2.3.4 On-PBX Diversion: On No Reply.....Page 8	
	2.3.5 Off-PBX Diversion: Immediate or On-Busy..Page 9	
	2.3.6 Off-PBX Diversion: On No Reply.....Page 10	
	2.3.7 Chaining of Call Diversions.....Page 11	
	2.3.8 Controlled Diversion.....Page 12	
	2.3.9 Redirection.....Page 12	
	2.3.10 Night Service.....Page 12	
3	COMPLIANCE	Page 13

HISTORY

Issue 1 - January 1995

Issue 2 - March 2001 - Specification renamed as DPNSS[188]

1 GENERAL

1.1 This section details the signalling requirements of DPNSS 1 for the Number Presentation Restriction Supplementary Service.

1.2 Subsection 2 details the service within DPNSS 1.

1.3 Subsection 3 shows the Compliance.

1.4 The description is given in the form of Message Sequence Diagrams (MSDs) followed by explanatory text.

1.5 The text is referenced from MSDs at appropriate points in the sequences.

1.6 Message contents for successful calls are shown in MSDs. Messages and their contents for alternative sequences (eg for unsuccessful calls) are detailed in the text.

1.7 Coding of the contents of messages is given in SECTION 4.

2 NUMBER PRESENTATION RESTRICTION WITHIN DPNSS 1

2.1 DEFINITION

The Number Presentation Restriction (NPR) Supplementary Service enables parties to indicate that the presentation of their identities should be restricted.

2.2 DESCRIPTION

The manner in which Number Presentation Restriction is applied is PBX dependent.

A PBX may withhold the presentation from, for example, ordinary users, operators, call logging devices, etc (see compliance).

Presentation restriction is indicated by means of Number Presentation Restriction Strings NPR-A, NPR-B and NPR-O.

2.2.1 Use of NPR-A

Where an OLI is sent in an ISRM, RM, ERM or SSRM then NPR-A may be included in the same Selection Block to indicate that the address conveyed by the OLI is presentation restricted.

NPR-A shall not be included in any other message.

2.2.2 Use of NPR-B

Where a CLI is sent in any message other than an ISRM, RM, ERM or SSRM then NPR-B may be included in the same Indication Block to indicate that the address conveyed by the CLI is presentation restricted.

Where a NAM, or a CRM sent in response to an ISRM, RM or ERM, is sent without a CLI (eg a NAM or a CRM containing DVT-I) then NPR-B may be included to indicate that the address conveyed by the received Destination Address digits is presentation restricted.

NOTE: A PBX may consider NPR-B to refer to the address conveyed by the Destination Address digits sent rather than to a CLI received, if the CLI is received in a context in which it can be considered to be unrecognised.

NPR-B shall not be included in an ISRM, RM, ERM or SSRM.

2.2.3 Use of NPR-O

Where one of the following Strings is sent in any message then NPR-O may be included in the same Selection or Indication Block to indicate that the address conveyed by that String is presentation restricted:

OCP; DVD-I/B; DVD-R; DVG-I/B; DVG-R; RCF; NS-DVD, and NS-RDVD.

Future issues of this specification may specify additional uses of NPR-O.

2.2.4 NPR String Identifier Code Suffixes

The NPR String Identifier Codes shall have no Suffix, an "A" Suffix, or a "B" Suffix depending on the requirements of a network with respect to how PBXs that do not recognise NPR Strings should be forced to respond to their receipt.

The way in which a PBX allocates NPR String Identifier Code Suffixes is implementation dependent, however, where NPR-O is sent as a consequence of receiving NPR-B the Suffix allocated to the NPR-O String Identifier shall be the same as that of the received NPR-B String.

2.2.5 NPR Restriction Domains

The NPR Supplementary Service provides an option to limit presentation restriction to different domains, eg private network and public network. Restriction domains are indicated by a Parameter to the NPR-A/B/O Strings.

A PBX that does not support restriction domains shall neither send the Parameter nor act upon its receipt. Consequently a PBX that does not support restriction domains will always interpret receipt of NPR-A/B/O as indicating total restriction.

Where a PBX that supports restriction domains sends NPR-O as a consequence of receiving NPR-B, the content of the Parameter to NPR-O shall be the same as that received in NPR-B.

2.3 OUTLINE OF OPERATION

The following MSDs and descriptions detail examples of the use of Number Presentation Restriction, within Simple Call and for a selection of Supplementary Service signalling sequences:

- 2.3.1 Simple Call
- 2.3.2 Transfer
- 2.3.3 On-PBX Diversion: Immediate or On-Busy
- 2.3.4 On-PBX Diversion: On No Reply
- 2.3.5 Off-PBX Diversion: Immediate or On-Busy
- 2.3.6 Off-PBX Diversion: On No Reply
- 2.3.7 Chaining of Call Diversions
- 2.3.8 Controlled Diversion
- 2.3.9 Redirection
- 2.3.10 Night Service

2.3.1 NUMBER PRESENTATION RESTRICTION – SIMPLE CALL

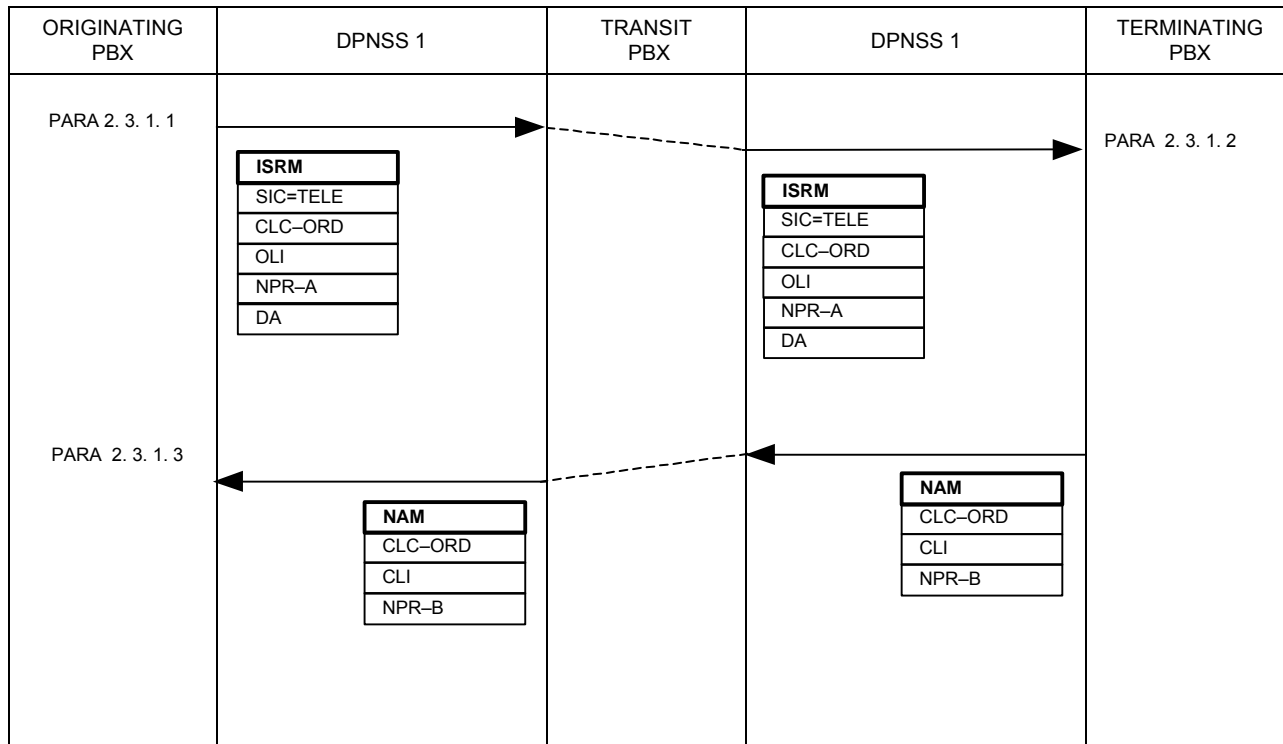

2.3.1.1 If the identity of the calling party is not to be revealed, then NPR-A shall be included in the ISRM.

2.3.1.2 Receipt of NPR-A indicates that the identity of the calling party is presentation restricted.

If the identity of the called party is not to be revealed then NPR-B shall be included in the NAM, or in the CRM sent in the case where the Terminating PBX is unable to present the call.

2.3.1.3 Receipt of NPR-B indicates that the identity of the called party is presentation restricted. This indication may be used in subsequent signalling sequences, for example in Redirection or Diversion on No Reply.

2.3.2 NUMBER PRESENTATION RESTRICTION – TRANSFER

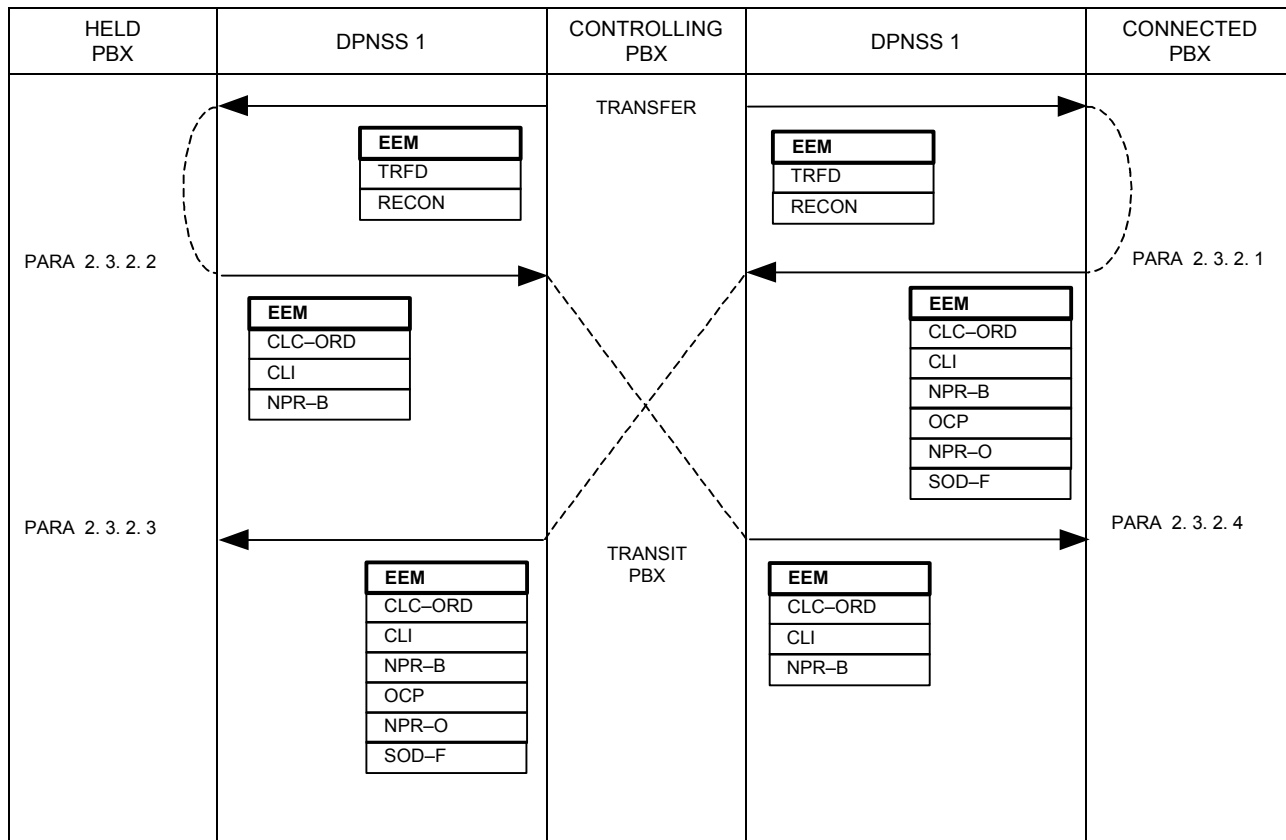

2.3.2.1 If the address of the Connected Party contained in CLI is not to be revealed, then NPR-B shall be included in the EEM sent to the Held PBX.

If the EEM contains OCP with an address that is not to be revealed then NPR-O shall also be included.

2.3.2.2 If the address of the held party is not to be revealed, then NPR-B shall be included in the EEM sent to the Connected PBX.

2.3.2.3 Receipt of NPR-B indicates that the address of the former connected party (contained in CLI) is presentation restricted.

The receipt of NPR-O indicates that the address contained in OCP is presentation restricted.

2.3.2.4 Receipt of NPR-B indicates that the address of the former held party (contained in CLI) is presentation restricted.

2.3.3 NUMBER PRESENTATION RESTRICTION – ON-PBX DIVERSION IMMEDIATE OR ON-BUSY

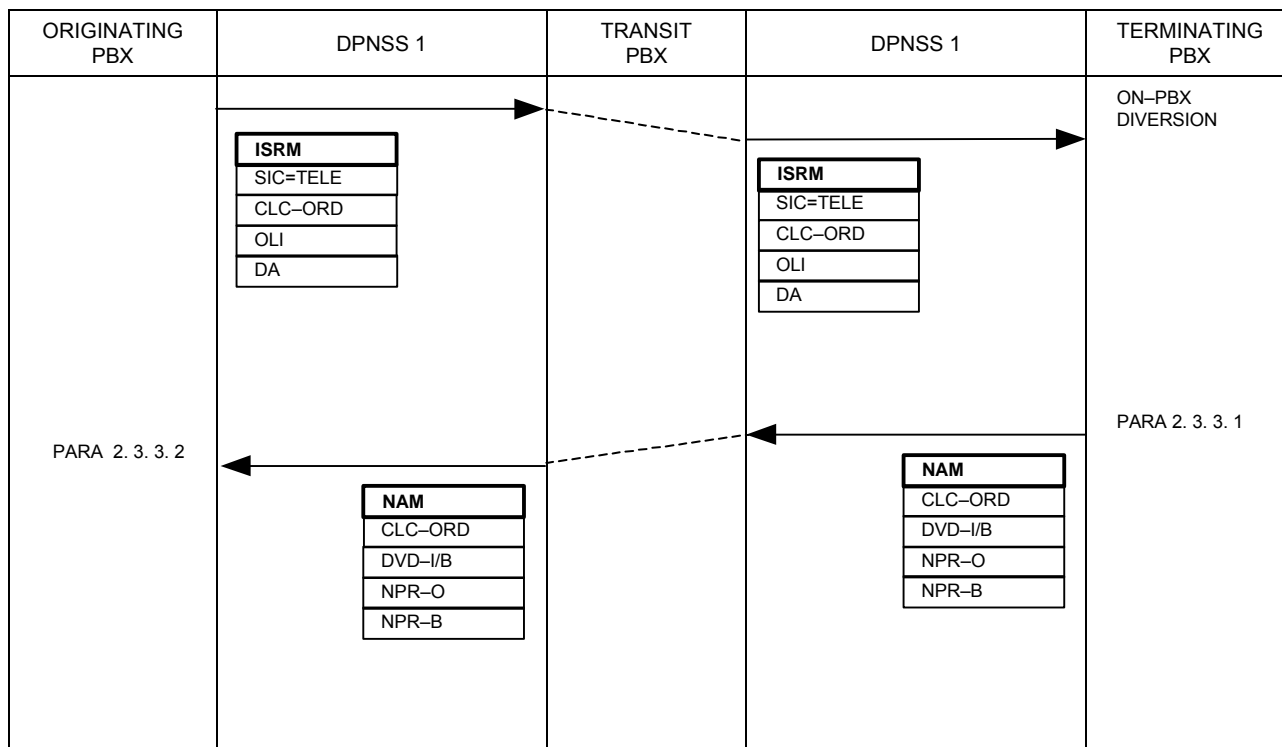

2.3.3.1 If the identity of the nominated extension (as indicated by the Parameter to DVD-I or DVD-B) is not to be revealed, then NPR-O shall be included in the NAM, or in the CRM sent if the call cannot be presented to the nominated party.

If the identity of the controlling party is not to be revealed then NPR-B shall be included in the NAM or CRM.

2.3.3.2 The presence of NPR-O indicates presentation restriction of the nominated party's identity as contained in DVD-I/B.

The presence of NPR-B indicates presentation restriction of the originally called party's identity.

2.3.4 NUMBER PRESENTATION RESTRICTION - ON-PBX DIVERSION ON NO REPLY

When the timeout to no-reply matures then, if the address of the nominated extension is presentation restricted, NPR-O shall be included in the EEM to qualify the Parameter to DVD-R.

NOTE: The presentation restriction status of the originally called party will already be known by the Originating PBX from receipt of the NAM as described in paragraph 2.3.1.3.

2.3.5 NUMBER PRESENTATION RESTRICTION – OFF-PBX DIVERSION IMMEDIATE OR ON-BUSY

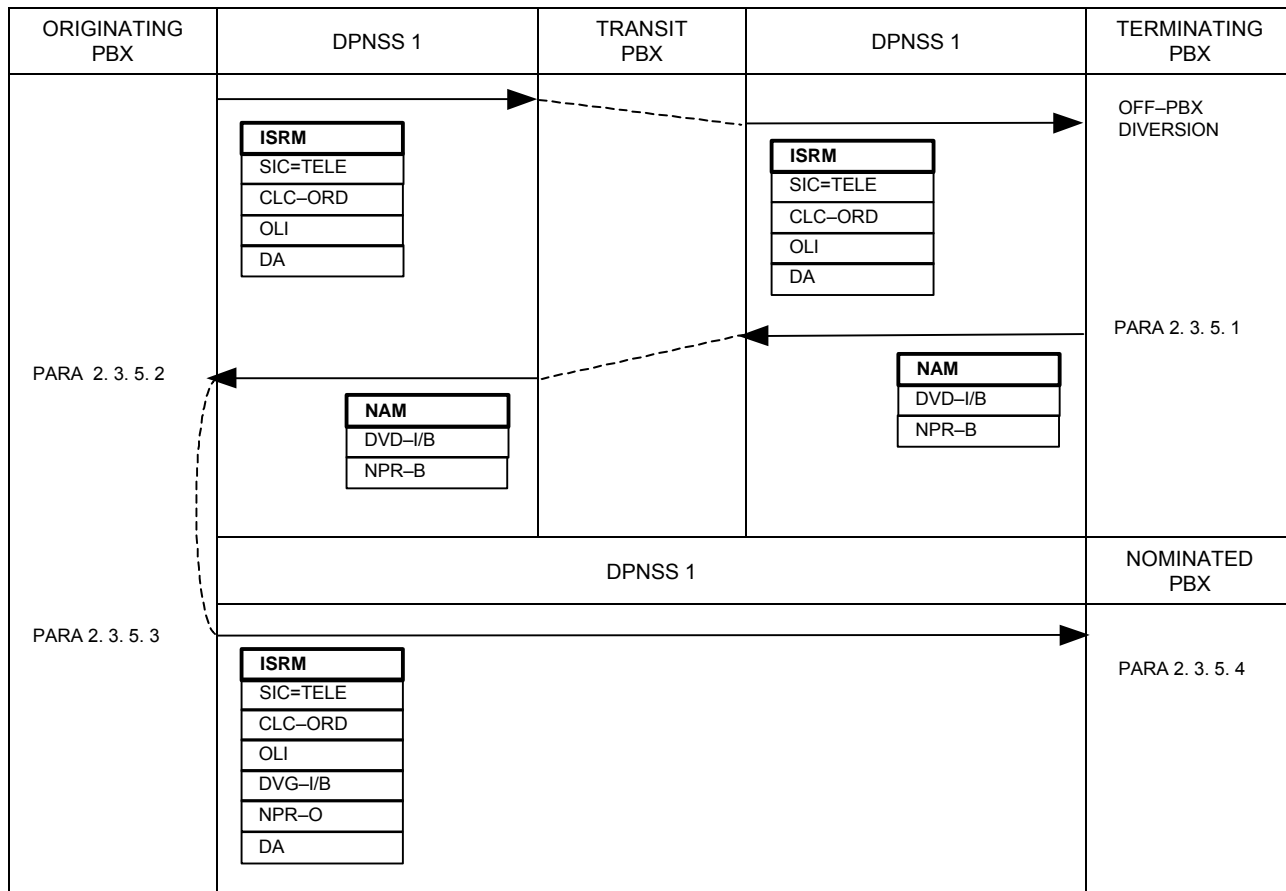

2.3.5.1 If the identity of the diversion controlling party is not to be revealed, NPR-B shall be included in the NAM containing DVT-I/B.

2.3.5.2 Receipt of NPR-B indicates presentation restriction of the originally called party's identity.

At this stage the restriction status of the nominated party's identity (contained in DVT-I/B) is not known, therefore display of this identity should be delayed until its status is known on receipt of the NAM or CRM on the new call.

2.3.5.3 Since the identity of the originally called party is not to be revealed (indicated by NPR-B in the NAM containing DVT-I/B) then the ISRM shall contain NPR-O.

If the identity of the originating party is not to be revealed then NPR-A shall be included in the ISRM (had this been the case in this example the ISRM of the original call would have contained NPR-A also).

2.3.5.4 Receipt of NPR-O indicates that the originally called party's address (Parameter to DVG-I/B) is presentation restricted.

**2.3.6 NUMBER PRESENTATION RESTRICTION - OFF-PBX DIVERSION ON NO
REPLY**

2.3.6.1 When the Originating PBX receives an EEM containing DVT-R it shall not reveal the address of the nominated party (the Parameter of DVT-R) until its restriction status is known, ie on receipt of the NAM on the new call.

NPR-0 shall be added to the ISRM containing DVG-R if the originally called party's address (the Parameter to DVG-R) is presentation restricted.

NOTE: The presentation restriction status of the originally called party will already be known by the Originating PBX from receipt of the NAM on the old call as described in paragraph 2.3.1.3 .

2.3.6.2 Receipt of NPR-0 in the ISRM at the nominated party's PBX indicates that the originally called party's address (the Parameter to DVG-R) is presentation restricted.

2.3.7 CHAINING OF CALL DIVERSIONS

In a chain of diversions, it is necessary to be able to identify the presentation restriction status of the addresses of: the originating party; the first controlling party, and the final nominated party.

Presentation restriction of the originating party's address shall be indicated by the use of NPR-A as described in 2.3.5.3.

The way in which presentation restriction of the addresses of the first controlling party and the final nominated party are indicated depends on the sequences of the on-PBX and off-PBX diversions encountered.

2.3.7.1 Off-PBX Diversion Encounters a Further Diversion

Where the second or subsequent Immediate or On-Busy diversion is off-PBX, the Originating PBX shall include NPR-O in the ISRM only if the originally called party's address (contained in the Parameter to DVG-I/B/R) is presentation restricted.

Where the final Immediate or On-Busy diversion is on-PBX, NPR-O shall be included in the NAM or CRM sent if the final nominated party's address is presentation restricted (as described in 2.3.3).

2.3.7.2 On-PBX Diversion Encounters a Further Diversion

If an incoming call that has not already been diverted is on-PBX diverted Immediate or On-Busy and then diverted Immediate or On-Busy again (either on-PBX or off-PBX) then NPR-B shall be included in the NAM or CRM sent only if the originally called party is presentation restricted (as described in 2.3.3).

Where the chain of diversions does not include an off-PBX diversion, NPR-O shall be included in the NAM or CRM sent if the final nominated party is presentation restricted. NPR-O shall not be included on behalf of any other parties in the diversion chain.

Where the original on-PBX diversion is followed by an off-PBX diversion, the Originating PBX shall include NPR-O in the new call ISRM to qualify DVG-I/B/R only if it has received NPR-B in the NAM from the originally called party's PBX.

2.3.8 CONTROLLED DIVERSION

A PBX supporting both Number Presentation Restriction and Controlled Diversion shall not reveal the identity of the Nominated Party until the restriction status of the Nominated Party is known.

2.3.9 REDIRECTION

2.3.9.1 If the originally called party's address is presentation restricted, then NPR-O shall be included with DVG-R or RCF in the ISRM of the redirecting call.

2.3.9.2 Receipt of NPR-O together with either DVG-R or RCF in the ISRM on the new call indicates that the originally called party's address is presentation restricted.

2.3.10 NIGHT SERVICE

2.3.10.1 If the originally called party is presentation restricted, then NPR-O shall be included with DVG-R in the ISRM of the new call.

2.3.10.2 Receipt of NPR-O together with DVG-R in the ISRM on the new call indicates that the originally called party's address is presentation restricted.

2.3.10.3 In the case of on-PBX Night Service Diversion or Rediversion the Strings NS-DVD or NS-RDVD in the EEM may be accompanied by NPR-O to indicate presentation restriction of the address of the night service point or the operator group, respectively.

3 COMPLIANCE SHEETS FOR SUPPLEMENTARY SERVICE: NUMBER PRESENTATION RESTRICTION

The Number Presentation Restriction Supplementary Service is an optional part of DPNSS 1 and its provision on a PBX is a matter for negotiation between a customer and his supplier (see FOREWORD in SECTION 0 of this specification). This subsection may be used as an aid to those negotiations.

NOTE: Whilst the provision of this service is optional, if it is provided, compliance with certain features of the service becomes mandatory.

Compliance with the service is considered in terms of the function(s) to be performed by the PBX, ie Transit, End or Branching, and the extent to which operators or extensions on the PBX can request the Service.

The Number Presentation Restriction Service is split into two parts:

- i. Presentation Restriction of Calling Party Numbers;
- ii. Presentation Restriction of Called/Connected Party Numbers.

The Compliance Tables are allocated a separate subsection for each part.

TABLE 0 should be completed by a manufacturer to indicate PBX capability and by a purchaser to indicate PBX requirements.

TABLE 0

SERVICE		APPLICABLE SUBSECTION OF COMPLIANCE SHEETS
Number Presentation Restriction: Calling Party Number		3.1
Number Presentation Restriction: Called/Connected Party Number		3.2

**3.1 COMPLIANCE SHEETS FOR NUMBER PRESENTATION RESTRICTION:
CALLING PARTY NUMBER**

The options available are given in TABLE 1. This table should be completed by a manufacturer to indicate the PBX capability and by a purchaser to indicate PBX requirements.

TABLES 2 and 3 should be completed as required to indicate the service options that are required/provided by the function. Where "YES" is pre-printed in a table it indicates that the feature is a mandatory part of the service.

TABLE 1

PBX FUNCTION		APPLICABLE TABLE
PBX with operators or extensions, some of which can request the service.		TABLE 2 and TABLE 3
PBX with operators or extensions, none of which can request the service.		TABLE 2
Transit PBX		TABLE 4

TABLE 2

COMPLIANCE TABLE FOR A PBX WITH OPERATORS OR EXTENSIONS IN A NETWORK THAT SUPPORTS PRESENTATION RESTRICTION OF CALLING PARTY NUMBERS		
SERVICE VARIANT		COMMENT
Able to act upon receipt of an NPR-A String?	YES	Specify action taken
Able to support restriction domains?		

TABLE 3

ADDITIONAL COMPLIANCE TABLE FOR A PBX WITH OPERATORS OR EXTENSIONS THAT ARE ABLE TO REQUEST THE SERVICE		
SERVICE VARIANT		COMMENT
Able to send an NPR-A String?	YES	NOTE 1
Able to support restriction domains?		

NOTE 1: Specify the NPR-A String Identifier Suffix allocation.

TABLE 4

COMPLIANCE TABLE FOR A TRANSIT PBX IN A NETWORK THAT SUPPORTS PRESENTATION RESTRICTION OF CALLING PARTY NUMBERS		
SERVICE VARIANT		COMMENT
Able to act as a transit for an NPR-A String?	YES	Inherent DPNSS 1 capability

**3.2 COMPLIANCE SHEETS FOR NUMBER PRESENTATION RESTRICTION:
CALLED/CONNECTED PARTY NUMBER**

The options available are given in TABLE 1. This table should be completed by a manufacturer to indicate the PBX capability and by a purchaser to indicate PBX requirements.

TABLES 2 and 3 should be completed as required to indicate the service options that are required/provided by the function. Where "YES" is pre-printed in a table it indicates that the feature is a mandatory part of the service.

TABLE 1

PBX FUNCTION		APPLICABLE TABLE
PBX with operators or extensions, some of which can request the service.		TABLE 2 and TABLE 3
PBX with operators or extensions, none of which can request the service.		TABLE 2
Transit PBX		TABLE 4

TABLE 2

COMPLIANCE TABLE FOR A PBX WITH OPERATORS OR EXTENSIONS IN A NETWORK THAT SUPPORTS PRESENTATION RESTRICTION OF CALLED/CONNECTED PARTY NUMBERS		
SERVICE VARIANT		COMMENT
Able to act upon receipt of an NPR-B String?	YES	Specify action taken
Able to act upon receipt of an NPR-O String?	YES	Specify action taken
Able to support restriction domains?		

TABLE 3

ADDITIONAL COMPLIANCE TABLE FOR A PBX WITH OPERATORS OR EXTENSIONS THAT ARE ABLE TO REQUEST THE SERVICE		
SERVICE VARIANT		COMMENT
Able to send an NPR-B String?	YES	NOTE 1
Able to send an NPR-O String?	YES	NOTE 1
Able to support restriction domains?		

NOTE 1: Specify the NPR-B and NPR-O String Identifier Suffix allocation.

TABLE 4

COMPLIANCE TABLE FOR A TRANSIT PBX IN A NETWORK THAT SUPPORTS PRESENTATION RESTRICTION OF CALLED/CONNECTED PARTY NUMBERS		
SERVICE VARIANT		COMMENT
Able to act as a transit for an NPR-B String?	YES	Inherent DPNSS 1 capability
Able to act as a transit for an NPR-O String?	YES	Inherent DPNSS 1 capability

DIGITAL PRIVATE NETWORK SIGNALLING SYSTEM NO 1 (DPNSS 1)

SECTION 49 - SUPPLEMENTARY SERVICE : NON SPECIFIED INFORMATION MESSAGE

CONTENTS

1	GENERAL	Page 2
2	NON SPECIFIED INFORMATION MESSAGE WITHIN DPNSS 1	Page 3
2.1	DEFINITION	Page 3
2.2	DESCRIPTION	Page 3
2.3	OUTLINE OF OPERATION	Page 4
2.3.1	NON-SPECIFIED INFORMATION MESSAGE - BACKWARD DIRECTION DURING ROUTING	Page 5
2.3.2	NON-SPECIFIED INFORMATION MESSAGE - AFTER ROUTING	Page 7
2.3.3	NEGOTIATION OF THE USE OF NSIMs	Page 9

HISTORY

Issue 1 - March 2001

1 GENERAL

1.1 This Section details the signalling requirements of DPNSS 1 for the Supplementary Service: Non Specified Information Message.

1.2 Subsection 2 describes the service within DPNSS 1.

1.3 The description is given in the form of Message Sequence Diagrams (MSDs) followed by explanatory text.

1.4 The text is referenced from MSDs at appropriate points in the sequence.

2 SUPPLEMENTARY SERVICE - NON SPECIFIED INFORMATION MESSAGE

2.1 DEFINITION

The Non Specified Information Message Supplementary Service permits a network to exploit the DPNSS 1 message handling rules to implement network dependent features/functions. It differs from the NSI Supplementary Service (as described in SECTION 15) in that it is based on the use of a dedicated message rather than the inclusion of network specific Supplementary Information Strings conveyed in other DPNSS 1 messages.

2.2 DESCRIPTION

This Supplementary Service enables information exchange to take place between PBXs in the network, to supplement the information flows in a network dependent manner.

The information exchange can occur between any PBXs in a network, at any point in a call in the backward direction and after completion of the routing in the forward direction. It can occur in conjunction with any other service.

The information is conveyed by means of NSIMs.

The structure of the Usage Identifier within the NSIM is defined in ANNEX 7 of SECTION 4. Currently, there are no codings of the Usage Identifier allocated that require the use of more than one octet. Valid codings of the extension bit field and Manufacturer Code field defined to date are shown below. These codings occupy bits 8 to 3 of a single octet Usage Identifier (bits 2 to 1 are occupied by the Manufacturer defined subcode).

Bit	8	7	6	5	4	3	
	0	0	0	0	0	0	- Reserved
	0	0	0	0	0	1	- BT
	0	0	0	0	1	0	- Ericsson
	0	0	0	0	1	1	- Lucent
	0	0	0	1	0	0	- Philips
	0	0	0	1	0	1	- Siemens
	0	0	0	1	1	0	- Westell
	0	0	0	1	1	1	- Mitel

All other values are reserved for further allocation.

Other manufacturers can be allocated a Usage Identifier code on request to the technical contact point for this specification.

Other than the Message Group/Type Identifier and the Usage Identifier, there is no restriction on how the remaining octets of the NSIM are coded. Since there is no way of guaranteeing whether or not information sent in an NSIM will be understood by the receiving PBX, it may be necessary for PBXs to first negotiate the use of NSIMs, for example by an exchange of NSI Strings conveyed in other DPNSS 1 messages. If an NSIM is received that contains an unrecognised Usage Identifier, the NSIM shall be treated in the same manner as an unrecognised message.

2.3 OUTLINE OF OPERATION

Non Specified Information Message is a general service that can be invoked at any point in a call for sending information in the backward direction, and for sending information in the forward direction following completion of routing (ie after the NAM has been sent or received). Consequently, the following MSDs are not exhaustive, and are intended only as examples.

Since specification of the minimum signalling throughput requirements for a PBX is outside the scope of DPNSS 1, care should be taken when designing network specific services based on the use of NSIMs with regard to the number of messages sent. A significant increase in message transmission compared to that which would apply for normal call handling could overload a component of the network. Consequently, it is recommended that a PBX that is capable of generating NSIMs be equipped with a limiting mechanism that can be invoked to overcome adverse effects on the network arising from excessive use of NSIMs.

Note: NSIMs may be used on both real and virtual calls.

2.3.1 NON-SPECIFIED INFORMATION MESSAGE – BACKWARD DIRECTION DURING ROUTING

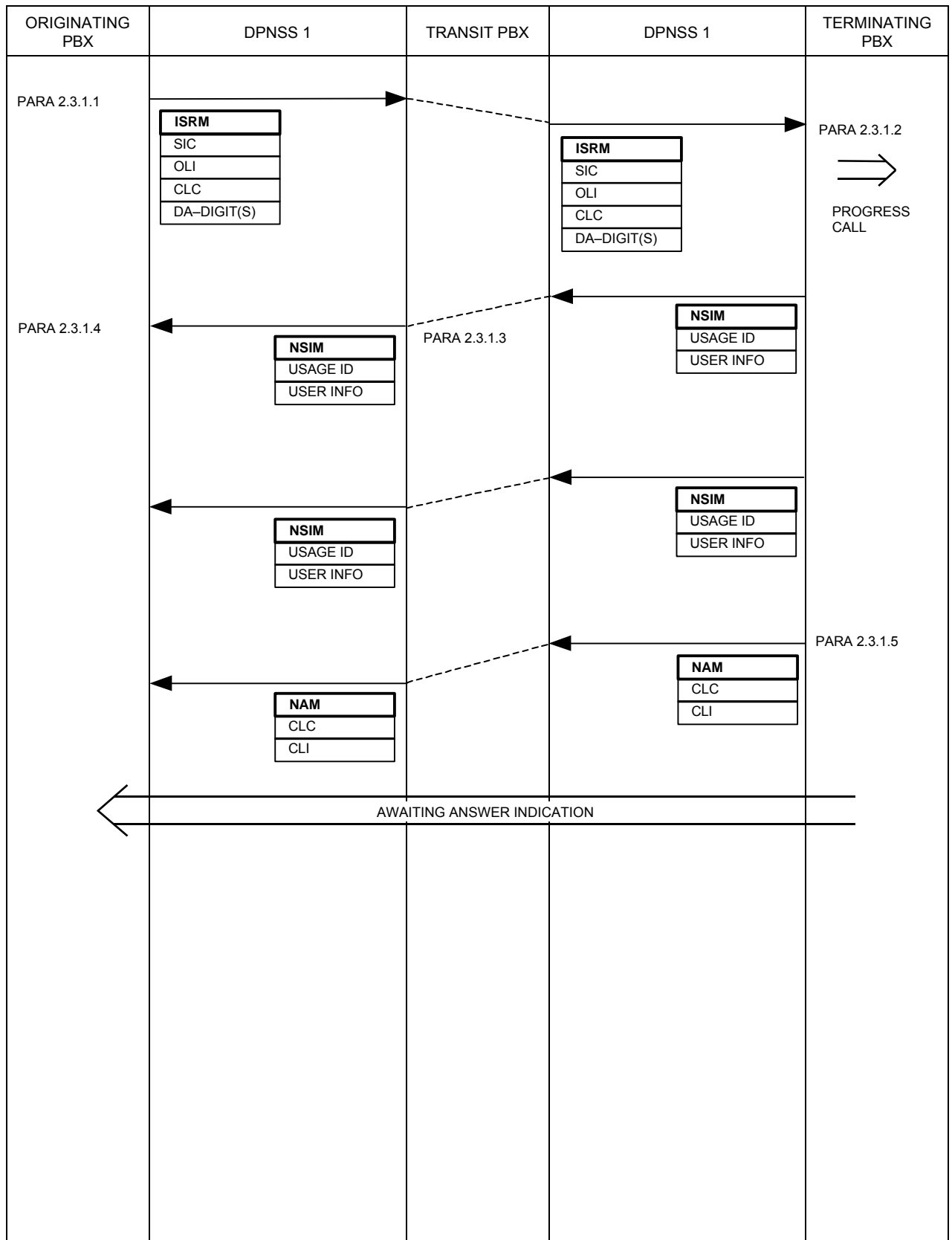

2.3.1.1 In this example the information to be conveyed in the backward direction is relevant to the routing phase.

2.3.1.2 On receipt of the ISRM, the Terminating PBX may send information in the backward direction via NSIMs. In this example, the NSIMs are sent unconditionally. An example of sending NSIMs only where it is known that the Originating PBX supports them is shown in Paragraph 2.3.3.

2.3.1.3 A Transit PBX will pass on NSIMs unchanged.

NOTE: a Transit PBX that does not support NSIMs should still pass on NSIMs unchanged (as unrecognised messages).

2.3.1.4 The Originating PBX may act upon the information contained in the NSIM(s) as appropriate if it recognises the Usage Identifier. If the Usage Identifier is not recognised, the NSIM is discarded.

2.3.1.5 On sending all the information, the call proceeds in the normal manner.

2.3.2 NON-SPECIFIED INFORMATION MESSAGE – AFTER ROUTING

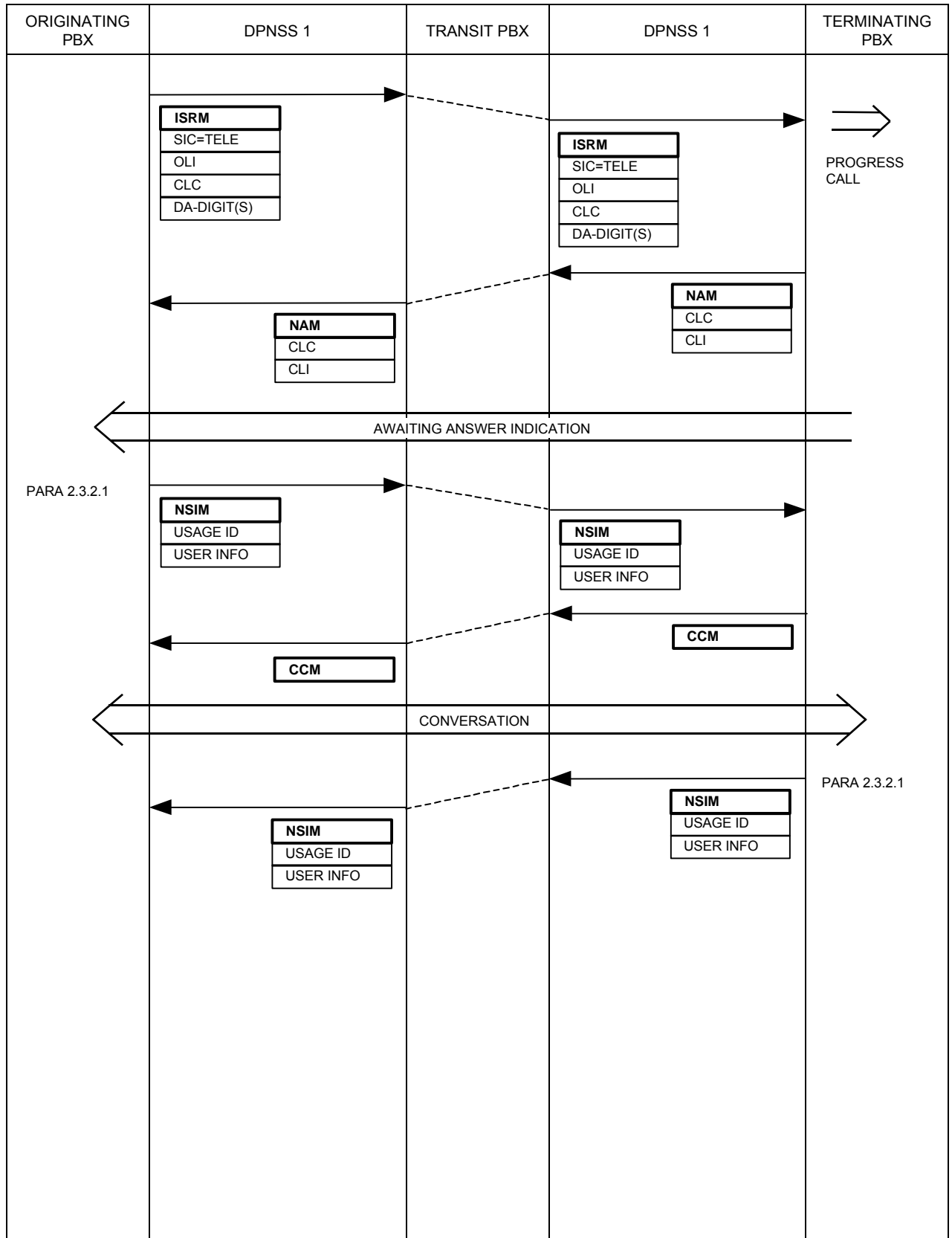

2.3.2.1 In this example, NSIMs are sent in both the awaiting answer and answered phases of the call, in either direction.

2.3.3 NEGOTIATION OF THE USE OF NSIMs (EXAMPLE 1 - DURING ROUTING)

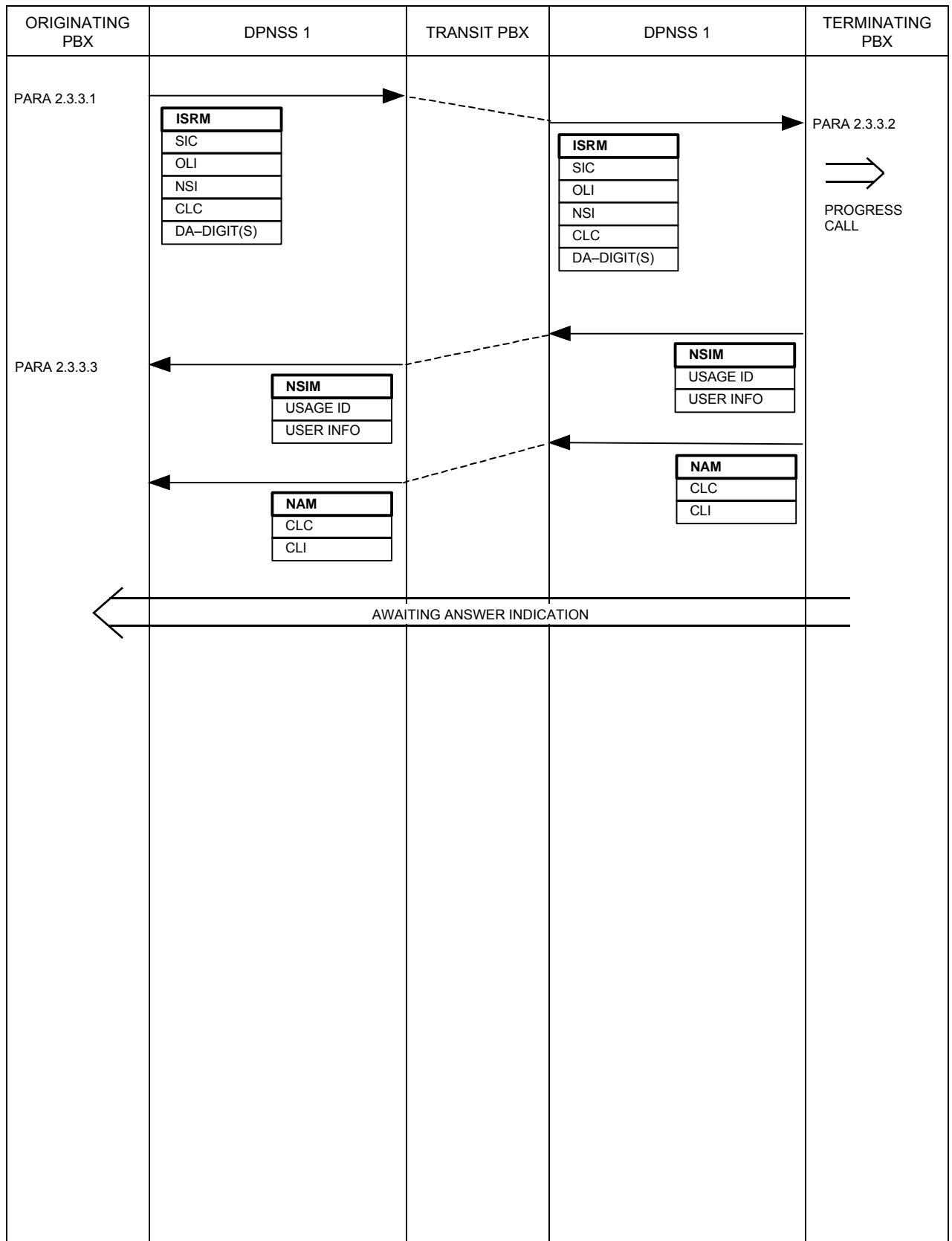

2.3.3 NEGOTIATION OF THE USE OF NSIMs (EXAMPLE 2 - AFTER ROUTING)

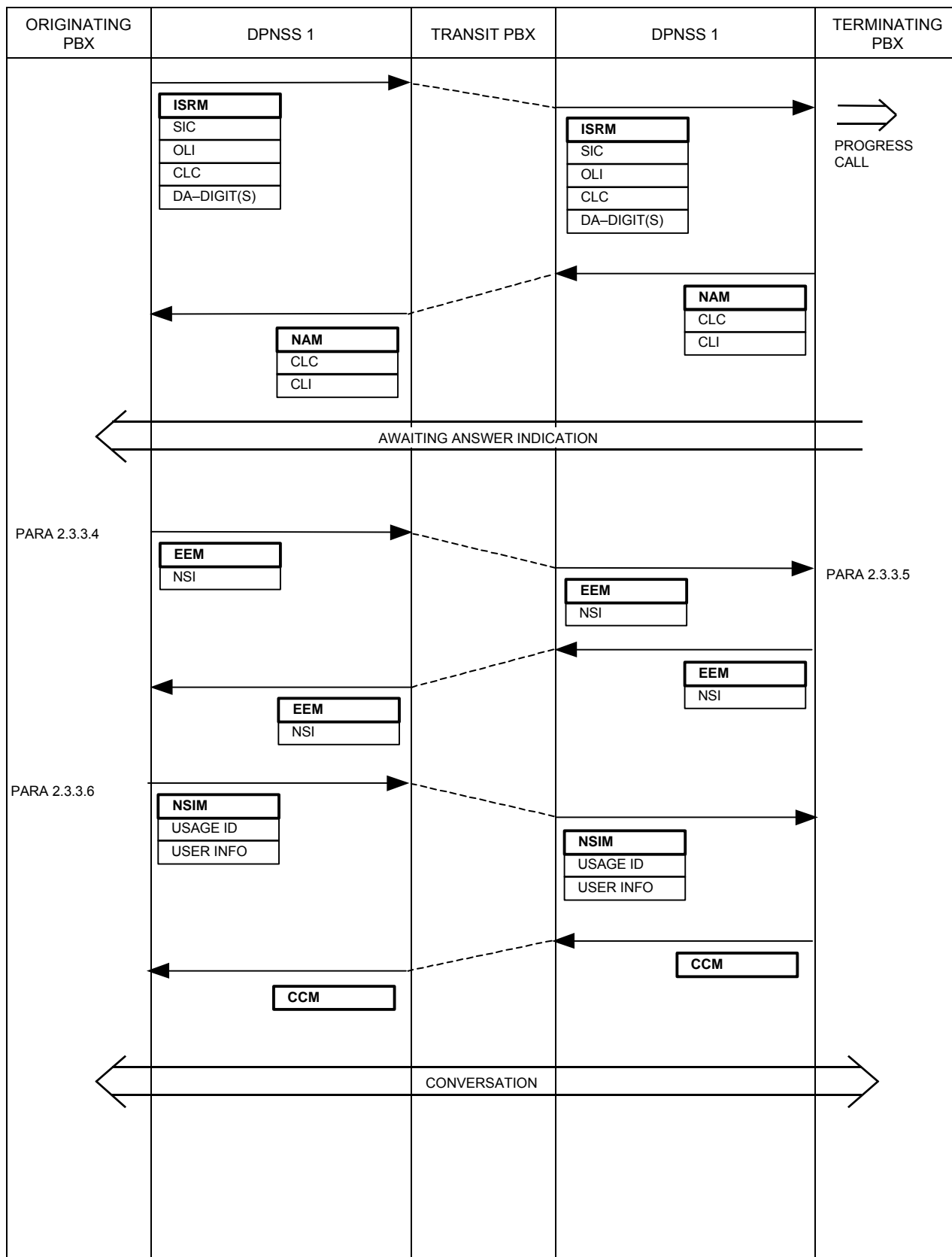

2.3.3.1 In certain cases it may be appropriate to first ascertain if the Originating and Terminating PBXs are able to communicate using NSIMs. This might be the case, for example, where the PBX wishing to send the NSIMs needs to know if the information sent would be understood.

In this example the information to be conveyed in the backward direction is relevant to the routing phase. This example shows an NSI Supplementary Information String being sent in the forward direction in the ISRM which could be used to inform the Terminating PBX that the Originating PBX is capable of acting upon information received in NSIMs (so that the Terminating PBX does not send messages that will only be discarded).

If the originating PBX is intending to send NSIMs later in the call (e.g. after the NAM) and wishes to know in advance if the NSIMs will be understood, the NSI string could be given an "A" suffix to elicit a NIM containing IG-SNU if the Terminating PBX does not understand the NSI.

2.3.3.2 On receipt of the ISRM, if the Terminating PBX recognises the NSI in the ISRM, it then sends information in the backward direction via NSIMs. If the NSI is not present, the Terminating PBX does not send any NSIMs.

2.3.3.3 The Originating PBX may act upon the information contained in the NSIM(s) as appropriate.

2.3.3.4 In this example, the routing phase of the call is complete and the Originating PBX wishes to send NSIMs, but only if it knows that the Terminating PBX will be able to act on them. Before any NSIMs are sent, an EEM containing NSI with a B suffix is sent to check that the Terminating PBX will understand the NSIMs.

Similarly the Terminating PBX could send NSI to check that the Originating PBX is capable of receiving its NSIMs.

2.3.3.5 On receipt of the EEM containing the NSI, the Terminating PBX returns an EEM containing NSI to confirm the ability to act upon the receipt of NSIMs.

2.3.3.6 On receipt of the confirmation, the NSIMs are sent.

If instead, an EEM containing SNU indicating the sent NSI is received, this informs the Originating PBX that the Terminating PBX did not understand the NSI and by implication would not understand the NSIMs. In such a case, the Originating PBX may decided not to send any NSIMs.

2.3.3.7 Note that where negotiation of use is important, there are certain events that may take place after negotiation, such as transfer, where use of NSIMs would need to be re-negotiated (because the distant End PBX is no longer the PBX that the previous negotiation was conducted with).